

EDS-G2008-EL/ELP Series Quick Installation Guide

Moxa EtherDevice Switch

Version 1.0, December 2022

Technical Support Contact Information
www.moxa.com/support

MOXA[®]

© 2022 Moxa Inc. All rights reserved.

P/N: 1802020081010



Overview

The EDS-G2008-EL/ELP Series has an 8-port combination to simplify network expansion. There are two housing types available for the user to select depending on the requirements of their application. The ELP has a plastic housing and the EL has a metal housing. The compact switches provide a cost-effective solution for your industrial Ethernet connection requirements.

The EDS-G2008-EL/ELP Series provides 12/24/48 VDC power input, and the switches are available with a standard operating temperature range from -10 to 60°C, or with a wide operating temperature range from -40 to 75°C (only available for the -T models in the EL Series). The switches are rugged enough to operate reliably in harsh industrial environments.

To provide greater versatility for use with applications from different industries, the EDS-G2008-EL/ELP Series also allows users to enable or disable broadcast storm protection (BSP), Quality of Service (QoS) function via the DIP switches on the top panel.

The EDS-G2008-EL/ELP switches can be easily installed with DIN-rail mounting as well as distribution boxes. The DIN-rail mounting capability with LED indicators ensure that the plug-and-play EDS-G2008-EL/ELP switches are reliable and easy to use.

NOTE Throughout this Quick Installation Guide, we use **EDS** as an abbreviation for Moxa EtherDevice Switch:

EDS = Moxa EtherDevice Switch



ATTENTION

This device complies with part 15 of FCC Rules. Operation is subject to the following two conditions: (1) This device may not cause harmful interference, and (2) this device must accept any interference received, including interference that may cause undesired operations.

Package Checklist

Your EDS is shipped with the following items. If any of these items are missing or damaged, please contact your customer service representative for assistance.

- Moxa EtherDevice™ Switch
- Quick installation guide (printed)
- Warranty card

Features

High Performance Network Switching Technology

- 10/100/1000BaseT(X) auto-negotiation speed, full/half duplex mode, auto MDI/MDI-X connection.
- IEEE 802.3 for 10BaseT.
- IEEE 802.3u for 100BaseT(X).
- IEEE 802.3ab for 1000BaseT(X).
- IEEE 802.3x for flow control.
- IEEE 802.1p for Quality of Service (QoS) traffic prioritized function.
- Store-and-forward switching process type.

Industrial-grade Reliability

- Broadcast storm protection to prevent network devices from crashing.

Rugged Design

- Operating temperature range from -10 to 60°C, or extended operating temperature from -40 to 75°C for “-T” models.
- Rugged high-strength case.
- DIN-rail or wall mounting ability.



WARNING

The power for this product is intended to be supplied by a Listed Power Supply, with output marked LPS, and rated to deliver 12 to 48 VDC at a maximum of 0.33 A.

Panel Layout of EDS-G2008-EL/EDS-G2008-ELP

EDS-G2008-EL
Front Panel View

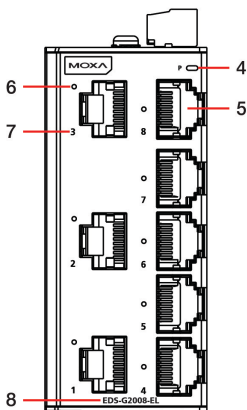

EDS-G2008-ELP
Front Panel View

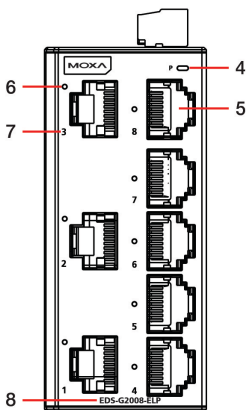

Top Panel View

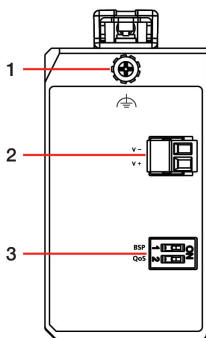

Top Panel View

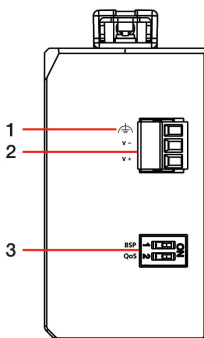

1. Chassis ground screw
2. Terminal block for power input
3. DIP switch
4. Power LED
5. 10/100/1000BaseT(X) Port
6. 10/100/1000BaseT(X) Port LED
7. Port number
8. Model name

Mounting Dimensions

EDS-G2008-EL Series

Unit = mm (inch)

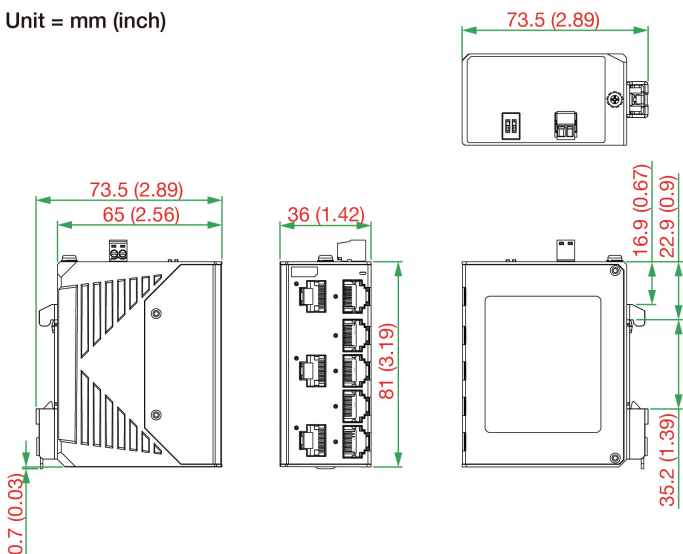

EDS-G2008-ELP Series

Unit = mm (inch)

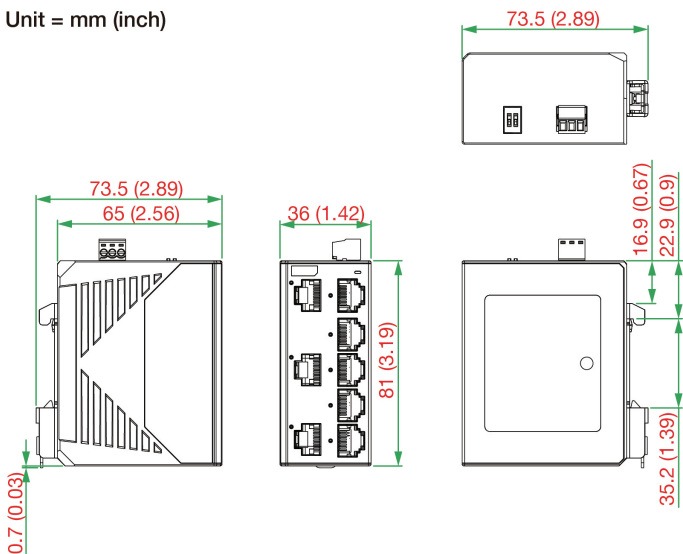

DIN-rail Mounting

When shipped, the DIN-rail mounting kit is fixed to the back panel of the EDS. Mount the EDS on the corrosion-free mounting rail that adheres to the EN 60715 standard.

Suggested Installation Method

STEP 1:

Insert the upper lip of the DIN-rail kit into the mounting rail.

STEP 2:

Press the device towards the mounting rail until it snaps into place. Alternatively, you can use a screwdriver to attach to the bottom of the DIN-rail kit and pull down.

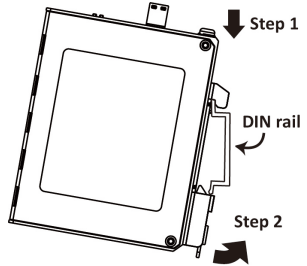

Suggested Removal Method

STEP 1:

Pull down the latch on the DIN-rail kit with a flat-head screwdriver.

STEP 2:

Slightly pull the device forward and lift up to remove it from the mounting rail.

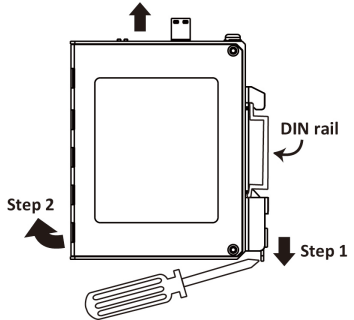



ATTENTION

When installing or removing the devices, please insert a flat-head screwdriver into the latch of the holding clamp and pull the latch downward rather than pushing it towards the DIN rail side, when removing the module from the rail.

If you want to change the position of the device on the DIN rail, please follow the steps shown in the images above. First, remove the device using a flat-head screwdriver and then re-install the device in the desired position. Please **DO NOT** directly move the device on the DIN rail, without uninstalling it first.

If the equipment is used in a manner not specified by the manufacturer, the protection provided by the equipment may be impaired.

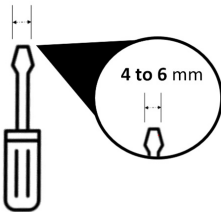
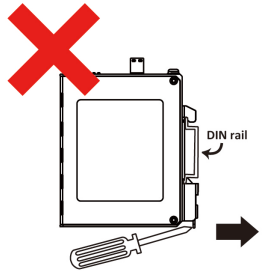
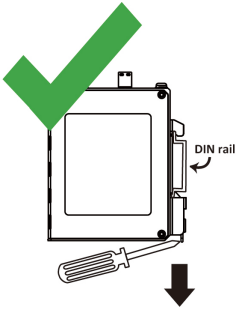

Please use a flat-head screwdriver with a head size of between 4 and 6 mm for proper installation or removal.



WARNING

1. The installation and the safety of any system incorporating the equipment is the responsibility of the assembler of the system.
2. This is an open type module and should be installed in a safety enclosure with mechanical rigidity and an appropriate IP rating

Wall Mounting (optional)

For some applications, you will find it convenient to mount EDS on the wall, as illustrated below.

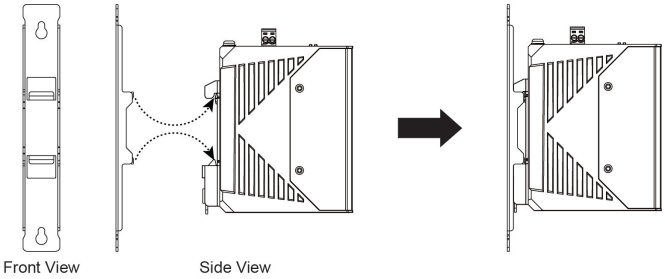

There are two options for installation: The first option is to hook the EDS DIN-rail latch on the opening of the wall mount kit (see picture above) and then mount the wall-mount kit on the wall with screws. (The other option is to perform these two steps in the other order.) The heads of the screws should be less than 6.0 mm in diameter, and the shafts should be less than 3.5 mm in diameter, as shown in the figure at the right.

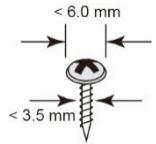

NOTE Before tightening screws into the wall, make sure the screw head and shank size are suitable by inserting the screw into one of the keyhole-shaped apertures of the Wall Mounting Plates.

Do not screw the screws in all the way—leave about 2 mm to allow room for sliding the wall mount panel between the wall and the screws.

Once the screws are fixed in the wall, insert the two screw heads through the large parts of the keyhole-shaped apertures, and then slide EDS downwards, as indicated. Tighten the two screws for added stability.

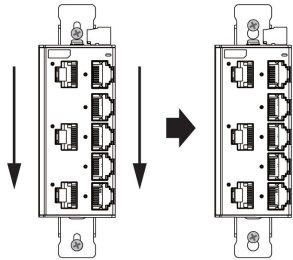

WARNING

External parts are hot. Take necessary precautions if it is necessary to touch.

Wiring Requirements



WARNING

Do not disconnect modules or wires unless the power supply has been switched off or the area is known to be non-hazardous. The devices may only be connected to the supply voltage shown on the type plate.

The devices are designed for operation with a Safety Extra-Low Voltage. Thus, they may only be connected to the supply voltage connections and to the signal contact with the Safety Extra-Low Voltages (SELV) in compliance with IEC950/EN60950/VDE0805/UL 61010-1/UL 61010-2-201.



WARNING

Safety First!

Be sure to disconnect the power cord before installing and/or wiring your Moxa EtherDevice Switch.

Calculate the maximum possible current in each power wire and common wire. Observe all electrical codes dictating the maximum current allowable for each wire size.

If the current goes above the maximum ratings, the wiring could overheat, causing serious damage to your equipment.

You should also pay attention to the following items:

- Use separate paths to route wiring for power and devices. If power wiring and device wiring paths must cross, make sure the wires are perpendicular at the intersection point.
NOTE: Do not run signal or communications wiring and power wiring in the same wire conduit. To avoid interference, wires with different signal characteristics should be routed separately.
- You can use the type of signal transmitted through a wire to determine which wires should be kept separate. The rule of thumb is that wiring that shares similar electrical characteristics can be bundled together.
- Keep input wiring and output wiring separated.
- It is strongly advised that you label wiring to all devices in the system when necessary.

Grounding Moxa EtherDevice Switch

Grounding and wire routing help limit the effects of noise due to electromagnetic interference (EMI). Run the ground connection from the ground screw to the grounding surface prior to connecting devices.

A 4 mm² conductor must be used when a connection to the external grounding screw is utilized.



ATTENTION

This product is intended to be mounted to a well-grounded mounting surface, such as a metal panel.

NOTE When using shielded cables to connect two Ethernet devices, a ground loop may occur if the shielding on the cables generates an additional grounding connection path. This can cause ground current to flow through to the Ethernet ports and damage the devices. Therefore, STP cables must only be connected to the ground at one end.

Wiring the Power Input

The top two contacts and the bottom two contacts of the 2 or 3 contact terminal block connector on the EDS's top panel are used for the EDS's two DC inputs. Top and front views of one of the terminal block connectors are shown here.

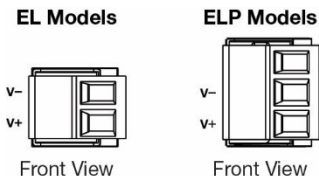

STEP 1:

Insert the negative/positive DC wires into the V-/V+ terminals.

STEP 2:

To keep the DC wires from pulling loose, use a small flat-blade screwdriver to tighten the wire-clamp screws on the front of the terminal block connector.

STEP 3:

Insert the plastic terminal block connector prongs into the terminal block receptor, which is located on the EDS's top panel.

NOTE The power source comes from secondary circuits. These circuits are separated from mains circuits by a transformer in which the primary windings are separated from the secondary windings by reinforced installation, double installation, or a screen connected to the protective conductor terminal.



ATTENTION

Before connecting the EDS to the DC power inputs, make sure the DC power source voltage is stable.



ATTENTION

Power Terminal plug wiring size 28-14 AWG, tighten to 1.7 in-lbs. **Only use copper conductors.**



ATTENTION

The cable that is connected to the field wiring terminals must be capable of withstanding at least 105°C.

Communication Connections

The EDS-G2008-EL/ELP models have 10/100/1000BaseT(X) Ethernet ports.

10/100/1000BaseT(X) Ethernet Port Connection

The 10/100/1000BaseT(X) ports located on the EDS's front panel are used to connect to Ethernet-enabled devices.

Below we show pinouts for both MDI (NIC-type) ports and MDI-X (HUB/Switch-type) ports, and also show cable wiring diagrams for straight-through and cross-over Ethernet cables.

10/100BaseT(x) RJ45 Pinouts

MDI Port Pinouts

Pin	Signal
1	Tx+
2	Tx-
3	Rx+
6	Rx-

MDI-X Port Pinouts

Pin	Signal
1	Rx+
2	Rx-
3	Tx+
6	Tx-

8-pin RJ45

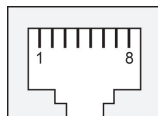

1000BaseT(x) RJ45 Pinouts

Pin	MDI	MDI-X
1	BI_DA+	BI_DB+
2	BI_DA-	BI_DB-
3	BI_DB+	BI_DA+
4	BI_DC+	BI_DD+
5	BI_DC-	BI_DD-
6	BI_DB-	BI_DA-
7	BI_DD+	BI_DC+
8	BI_DD-	BI_DC-

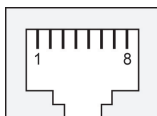

RJ45 (8-pin) to RJ45 (8-pin) Straight-through Cable Wiring

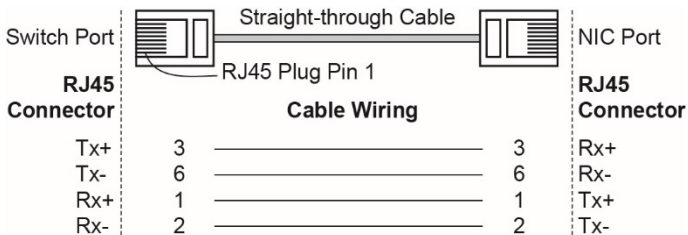

RJ45 (8-pin) to RJ45 (8-pin) Cross-over Cable Wiring

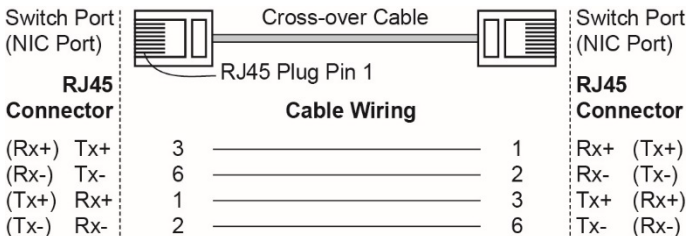

DIP Switch Settings



Front View

DIP Switch	Setting	Description
Quality of Service (QoS)	ON	Enable the Quality of Service to handle packet priorities in four WRR queues. <i>QoS priority mapping matrix in each queue</i>
	OFF	Disable the Quality of Service.
Broadcast Storm Protection (BSP)	ON	Enables broadcast storm protection (at a maximum of 2048 broadcast packets per second) for each Ethernet port.
	OFF	Disables the broadcast storm protection.

QoS 3bit priority	7, 6	5, 4	3, 2	1, 0
Queues	3	2	1	0
WRR	8	4	2	1

LED Indicators

The front panel of the Moxa EtherDevice Switch contains several LED indicators. The function of each LED is described in the table below.

LED	Color	State	Description
PWR (P)	Amber	On	Power is being supplied to power input PWR.
		Off	Power is not being supplied to power input PWR.
10M/100M	Amber	On	When the port is active and links on at 10/100 Mbps.
		Blinking	When the port's data is being transmitted at 10/100 Mbps.
		Off	When the port is inactive or link down.
1000M	Green	On	When the port is active and links on at 1000 Mbps.
		Blinking	When the port's data is being transmitted at 1000 Mbps.
		Off	When the port is inactive or link down.

Auto MDI/MDI-X Connection

The Auto MDI/MDI-X function allows users to connect the EDS's 10/100/1000BaseT(X) ports to any kind of Ethernet device, without paying attention to the type of Ethernet cable being used for the connection. This means that you can use either a straight-through cable or cross-over cable to connect the EDS to Ethernet devices.

Triple Speed Functionality and Switching

The EDS's 10/100/1000 Mbps RJ45 switch port auto negotiates with the connected device for the fastest data transmission rate supported by both devices. The EDS is a plug-and-play device, so software configuration is not required at installation or during maintenance.

The half/full duplex mode for the RJ45 switched ports is user dependent and changes (by auto-negotiation) to full or half duplex, depending on which transmission speed is supported by the attached device.

Switching, Filtering, and Forwarding

Each time a packet arrives at one of the switched ports, a decision is made to either filter or forward the packet. Packets with source and destination addresses belonging to the same port segment will be filtered, constraining those packets to one port, and relieving the rest of the network from the need to process them. A packet with a destination address on another port segment will be forwarded to the appropriate port, and will not be sent to the other ports where it is not needed. Packets that are used in maintaining the operation of the network (such as the occasional multi-cast packet) are forwarded to all ports except the incoming port. The EDS operates in the store-and-forward switching mode, which eliminates bad packets and enables peak performance to be achieved when there is heavy traffic on the network.

Address Learning

The Moxa EDS has an address table that can hold up to 4,000 node addresses, which makes it suitable for use with large networks. The address tables are self-learning, so that as nodes are added or removed, or moved from one segment to another, EDS automatically keeps up with new node locations. An address-aging algorithm causes the least-used addresses to be deleted in favor of newer, more frequently used addresses. To reset the address buffer, power down the unit and then power it back up.

Auto-Negotiation and Speed Sensing

The EDS's RJ45 Ethernet ports independently support auto-negotiation for transmission speeds of 10 Mbps, 100 Mbps, and 1000 Mbps with operation according to the IEEE802.3 standard. This means that some nodes could be operating at 10 Mbps, while at the same time, other nodes are operating at 100 Mbps or 1000 Mbps.

When an RJ45 cable is connected, auto-negotiation takes place, and then each time a LINK is enabled. The EDS advertises its capability for using 10 Mbps, 100 Mbps, or 1000 Mbps, transmission speeds, with the device at the other end of the cable expected to advertise similarly. Depending on what type of device is connected, this will result in agreement to operate at a speed of 10 Mbps, 100 Mbps, or 1000 Mbps.

If an EDS's RJ45 Ethernet port is connected to a non-negotiating device, it will default to 10 Mbps speed and half-duplex mode, as required by the IEEE802.3 standard.

Specifications

Technology	
Standards	IEEE 802.3 for 10BaseT, IEEE 802.3u for 100BaseT(X), IEEE 802.3ab for 1000BaseT(X), IEEE 802.1p for Class of Service
Flow Control	IEEE 802.3x flow control, back pressure flow control
Interface	
RJ45 Ports	10/100/1000BaseT(X) auto negotiation speed
LED Indicators	PWR, 10M/100M/1000M
DIP Switch	QoS, Broadcast Storm Protection (BSP)
Switch Properties	
MAC Table Size	4 K
Packet Buffer Size	1.5 Mbits
Processing Type	Store and Forward
Power	
Input Voltage	12-48 VDC inputs
Input Current (max.)	EDS-G2008-EL/ELP: 0.33 A
Connection	Removable 2-contact terminal block for EL Series; Removable 3-contact terminal block for ELP Series
Overload Current Protection	Present

Reverse Polarity Protection	Present
Mechanical	
Casing	Metal housing for EL Series; plastic housing for ELP Series
Dimensions (W x H x D)	EDS-G2008-EL/ELP: 36 × 81 × 65 mm (1.4 × 3.19 × 2.56 in)
Weight	EDS-G2008-ELP: 90 g (0.20 lb) EDS-G2008-EL: 163 g (0.36 lb)
Installation	DIN-rail, Wall Mounting (optional kit)
Environmental Limits	
Note: For indoor use only.	
Operating Temperature	-10 to 60°C (32 to 140°F) -40 to 75°C (-40 to 167°F) (only available for the -T models in the EL Series)
Storage Temperature	-40 to 85°C (-40 to 185°F)
Ambient Relative Humidity	5 to 95% (non-condensing)
Regulatory Approvals	
Safety	UL 61010-2-201, EN 62368-1(LVD)
EMC	EN 55022/24, EN 61000-6-2/6-4
EMI	FCC Part 15B, CISPR 32 (EN 55032) Class A
EMS	CISPR 35 (EN 55035) EN 61000-4-2 (ESD) EN 61000-4-3 (RS) EN 61000-4-4 (EFT) EN 61000-4-5 (Surge) EN 61000-4-6 (CS) EN 61000-4-8 (PFMF)
Shock	IEC60068-2-27
Free Fall	IEC60068-2-32
Vibration	IEC60068-2-6
Warranty	5 years

- NOTE**
- This device is intended for use indoor and at altitudes up to 2000 meters.
 - Suitable for installation in a pollution degree 2 environment.
 - Clean the device with a soft dry or wet cloth.
 - For any repair or maintenance needs, please contact us.
 - Moxa Inc.
No. 1111, Heping Rd., Bade Dist., Taoyuan City 334004, Taiwan +886-3-2737575



Hot Surface Label.



Functional earth terminal.