

NPort W2150A-W4/W2250A-W4 Series User Manual

Version 1.2, June 2024

www.moxa.com/products

MOXA[®]

© 2024 Moxa Inc. All rights reserved.

NPort W2150A-W4/W2250A-W4 Series User Manual

The software described in this manual is furnished under a license agreement and may be used only in accordance with the terms of that agreement.

Copyright Notice

© 2024 Moxa Inc. All rights reserved.

Trademarks

The MOXA logo is a registered trademark of Moxa Inc.
All other trademarks or registered marks in this manual belong to their respective manufacturers.

Disclaimer

- Information in this document is subject to change without notice and does not represent a commitment on the part of Moxa.
- Moxa provides this document as is, without warranty of any kind, either expressed or implied, including, but not limited to, its particular purpose. Moxa reserves the right to make improvements and/or changes to this manual, or to the products and/or the programs described in this manual, at any time.
- Information provided in this manual is intended to be accurate and reliable. However, Moxa assumes no responsibility for its use, or for any infringements on the rights of third parties that may result from its use.
- This product might include unintentional technical or typographical errors. Changes are periodically made to the information herein to correct such errors, and these changes are incorporated into new editions of the publication.

Technical Support Contact Information

www.moxa.com/support

Table of Contents

1. Introduction	5
Overview	5
Package Checklist	5
Product Features	6
Serial Port Pin Assignments	6
2. Getting Started	7
Overview	7
Panel Layout	7
LED Indicators	8
Top Panel LED Indicators	8
End Panel LED Indicators	8
Pull High/Low Resistors for RS-422/485	9
Placement Options	10
Connecting the Hardware	10
Connecting to the Network	11
Connecting the Power	11
Connecting to a Serial Device	11
3. Initial IP Configuration	12
Overview	12
Factory Default IP Settings	12
Using the Telnet Console to an Assign IP Address	12
Using the Serial Console to an Assign IP Address	15
4. Introduction to Operation Modes	17
Overview	17
Real COM Mode	17
RFC2217 Mode	18
TCP Server Mode	18
TCP Client Mode	18
UDP Mode	19
Pair Connection Modes	19
Ethernet Modem Mode	19
Reverse Terminal Mode	20
5. Installing and Configuring the Software	21
Overview	21
Device Search Utility (DSU)	21
Installing the DSU	21
Finding NPort Device Servers on a Network	23
Modifying NPort IP Addresses	24
Upgrading NPort Firmware	25
NPort Windows Driver Manager	27
Installing NPort Windows Driver Manager	27
Adding Mapped Serial Ports	30
Configuring Mapped Serial Ports	32
Command-Line Installation/Removal	36
Linux Real TTY Drivers	38
Basic Steps	38
Installing Linux Real TTY Driver Files	38
Enter the new IP address and netmask. If multiple units were selected, you mayMapping TTY Ports	39
Removing Mapped TTY Ports	39
Removing Linux Driver Files	40
UNIX Fixed TTY Drivers	40
Installing the UNIX Driver	40
Configuring the UNIX Driver	41
6. Web Console: Basic Settings	42
Overview	42
Basic Settings	43
7. Web Console: Network Settings	45
Overview	45

Network Settings.....	45
General Settings	45
Ethernet/Bridge Settings	46
WLAN Settings.....	48
Advanced Settings.....	62
8. Web Console: Serial Port Settings.....	63
Overview	63
Serial Port Settings.....	63
Communication Parameters	82
Data Buffering/Log	83
9. Web Console: System Management	85
Overview	85
System Management.....	85
Misc. Network Settings.....	85
Auto Warning Settings	89
Maintenance	92
Certificate	96
10. Web Console: System Monitoring	100
Overview	100
System Monitoring.....	100
Serial Status.....	100
System Status	102
11. Web Console: Restart	105
Overview	105
Restart.....	105
Restart System	105
Restart Ports.....	105
12. Android API Instructions	106
Overview	106
How to Start MxNPortAPI	107
MxNPortAPI Function Groups.....	108
Example Program	108
A. SNMP Agents with MIB II & RS-232-Like Groups.....	109
RFC1213 MIB-II Supported SNMP Variables	109
System MIB.....	109
Interfaces MIB	109
IP MIB	109
ICMP MIB	110
UDP MIB	110
Address Translation	110
TCP MIB.....	110
SNMP MIB	110
RFC1317: RS-232 MIB Objects	111
Generic RS-232-like Group	111
RS-232-like General Port Table	111
RS-232-like Asynchronous Port Group.....	111
The Input Signal Table	111
The Output Signal Table.....	111
B. Well-known Port Numbers.....	112
C. Ethernet Modem Commands	114
Dial-in Operation	114
Dial-out.....	114
Disconnection Request from Local Site	114
Disconnection Request from Remote Site.....	114
AT Commands.....	115
S Registers	116

1. Introduction

Overview

In this chapter, we introduce the basic features and specifications of the NPort W2150A-W4/W2250A-W4 Series and NPort W2150A-W4/W2250A-W4 Series-T, referred to collectively as the NPort W2150A-W4/W2250A-W4 Series.

The NPort W2150A-W4/W2250A-W4 Series of wireless device servers are used to connect RS-232/422/485 serial devices or Ethernet devices, including PLCs, meters, and sensors, to a wireless LAN. Your communications software will access serial devices or Ethernet devices from anywhere over a local LAN, WLAN, or the Internet. Moreover, the WLAN environment offers an excellent solution for applications in which the serial devices and Ethernet devices are moved frequently from place to place.

The NPort W2150A-W4/W2250A-W4 Series supports automatic IP configuration protocol (DHCP) and manual configuration using a standard web browser. Both IP configuration methods ensure quick and effective installation. In addition, a utility called "NPort Windows Driver Manager" makes port mapping easy.

The external antenna can be adjusted for maximum signal strength. You can also choose to use your own antenna for additional flexibility and scalability. A signal strength indicator on the front panel makes it easier for you to troubleshoot any connection problems.

The NPort W2150A-W4/W2250A-W4 Series offers different operation modes to ensure compatibility with standard network APIs, including TCP Server Mode, TCP Client Mode, and UDP Mode. Real COM/TTY drivers are provided to allow legacy serial-based software to communicate over an IP network instantly. This preserves your software investment while providing all the advantages of networking your serial devices.

For easier management, the NPort W2150A-W4/W2250A-W4 Series includes features such as password authentication, IP filtering, 64-bit and 128-bit WEP encryption, and SNMP support.

Package Checklist

Standard Accessories

- 1 NPort W2150A-W4 or NPort W2250A-W4 wireless device server
- 1 antenna 2.4/5 GHz: ANT-WDB-ASM-03 BK
- 100 to 240 VAC power adapter (excluding T models)*
- 1 Ethernet cable: CBL-RJ458P-100
- Quick installation guide (printed)
- Warranty card



NOTE

The package includes one power adapter suitable for your region.



NOTE

The operating temperature of the power adapter (included with the NPort W2150A-W4/W2250A-W4) is from 0 to 40°C (32 to 104°F). If your application is not in this range, please use a power adapter supplied according to the requirements below:

- The external power source must comply with UL listed, IEC 60950-1, or IEC/EN 62368-1
- Output complies to SELV/ES1, PS2/LPS; output rating 12 to 48 VDC, 0.455 A minimum
- A minimum ambient temperature of 55°C or 75°C. (55°C for the NPort W2150A-W4 and NPort W2250A-W4; 75°C for the NPort W2150A-W4-T and NPort W2250A-W4-T)

Optional Accessories

- DK35A: DIN-rail mounting kit (35 mm)
- Power-jack-to-terminal-block 12 cable (P/N: 9199000000900)



NOTE

Please notify your sales representative if any of the above items is missing or damaged.

Product Features

- Links serial and Ethernet devices to an IEEE 802.11a/b/g/n network
- Web-based configuration using built-in Ethernet or WLAN
- Secure boot for Moxa only authorized firmware allowed to run
- Remote configuration with HTTPS (TLS 1.3), SSH
- Secure data access with WEP, WPA, WPA2
- WPA/WPA2 Enterprise IEEE 802.1X/RADIUS (EAP-TLS 1.3)
- Fast roaming for quick automatic switching between access points
- Enhanced surge protection for serial, LAN, and power
- Offline port buffering and serial data log
- Dual power inputs (1 screw-type power jack, 1 terminal block)

Serial Port Pin Assignments

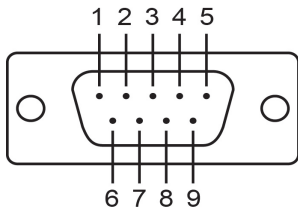

Pin	RS-232	RS-422/ RS-485 (4W)	RS-485 (2W)
1	DCD	TxD-(A)	-
2	RXD	TxD+(B)	-
3	TXD	RxD+(B)	Data+(B)
4	DTR	RxD-(A)	Data-(A)
5	GND	GND	GND
6	DSR	-	-
7	RTS	-	-
8	CTS	-	-
9	-	-	-

2. Getting Started

Overview

This chapter presents the hardware features of the NPort W2150-W4/W2250A-W4 Series and explains how to connect the hardware.

Panel Layout

NPort W2150A-W4/W2150A-W4-T

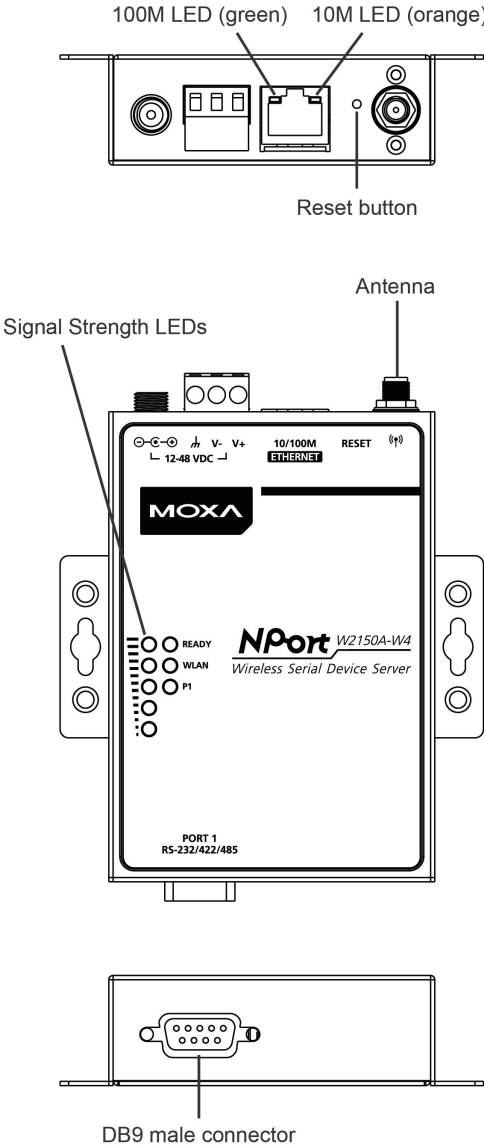

NPort W2250A-W4/W2250A-W4-T

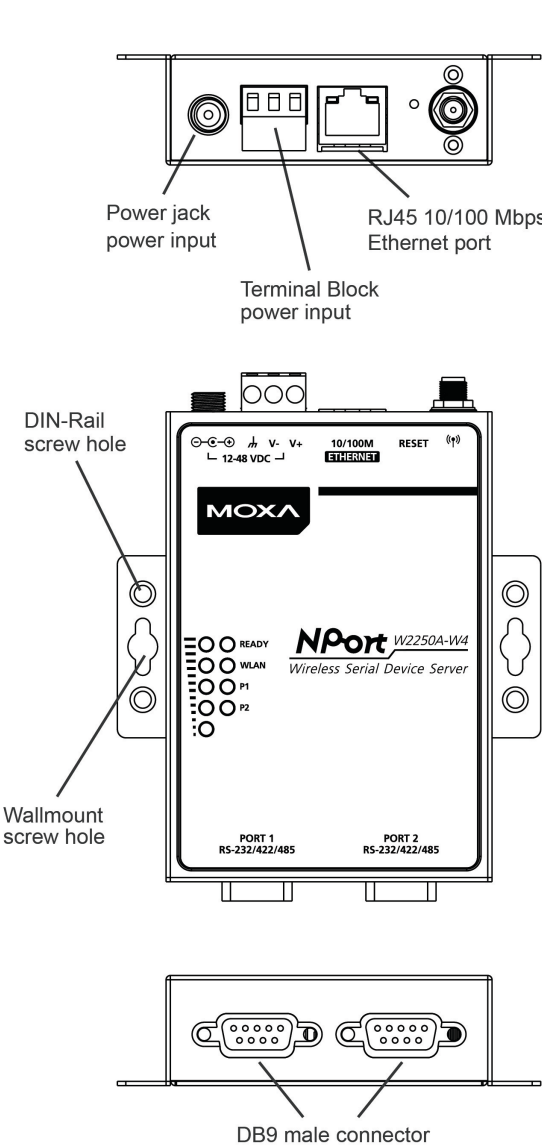

LED Indicators

Top Panel LED Indicators

Name	Color	Function
Ready	Red	Steady on: Power is on, and the NPort is booting up.
		Blinking: An IP conflict exists, or the DHCP server did not respond properly.
	Green	Steady on: The NPort is functioning normally. Blinking: The unit is responding to Locate function.
	Off	Power is off, or a power error condition exists.
WLAN	Green	Steady on: Wireless enabled Blinking: The NPort can't establish WLAN connection with AP (Infrastructure)
	Off	Wireless not enabled.
Port 1 Port 2	Orange	Serial port is receiving data.
	Green	Serial port is transmitting data.
	Off	No data is flowing to or from the serial port.
Signal Strength (5 LEDS)	Red	1 Red - the signal strength (RSSI) is worse than -88 dBm 2 Red - the signal strength (RSSI) is between -87 to -79 dBm
	Green	3 Green - the signal strength (RSSI) is between -78 to -68 dBm 4 Green - the signal strength (RSSI) is between -67 to -60 dBm 5 Green - the signal strength (RSSI) is between -59 to -45 dBm

End Panel LED Indicators

Name	Color	Function
Ethernet	Orange	10 Mbps Ethernet connection
	Green	100 Mbps Ethernet connection
	Off	Ethernet cable is disconnected

Pull High/Low Resistors for RS-422/485

You may need to set the pull high/low resistors when termination resistors are used for certain RS-422 or RS-485 environments.

S4 (Port 1) S5 (Port 2)	DIP 1 Pull high resistor	DIP 2 Pull low resistor	DIP 3 Termination resistor	DIP 4 Reserved
ON	1 K Ω	1 K Ω	120 Ω	-
OFF	*150 K Ω	*150 K Ω	*N/A	-

*Default

S5 is for NPort W2250A-W4 only

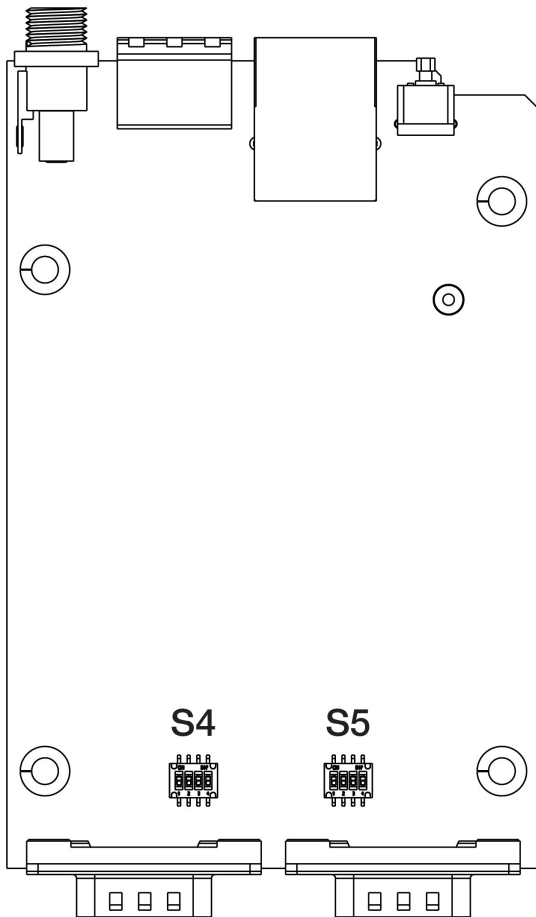

ATTENTION

Do not use the 1 K Ω setting while in RS-232 mode. Doing so will degrade the RS-232 signals and reduce the effective communication distance.

Placement Options

The NPort can be placed on a desktop or other horizontal surface. You can also install the NPort on a DIN-rail or on the wall.

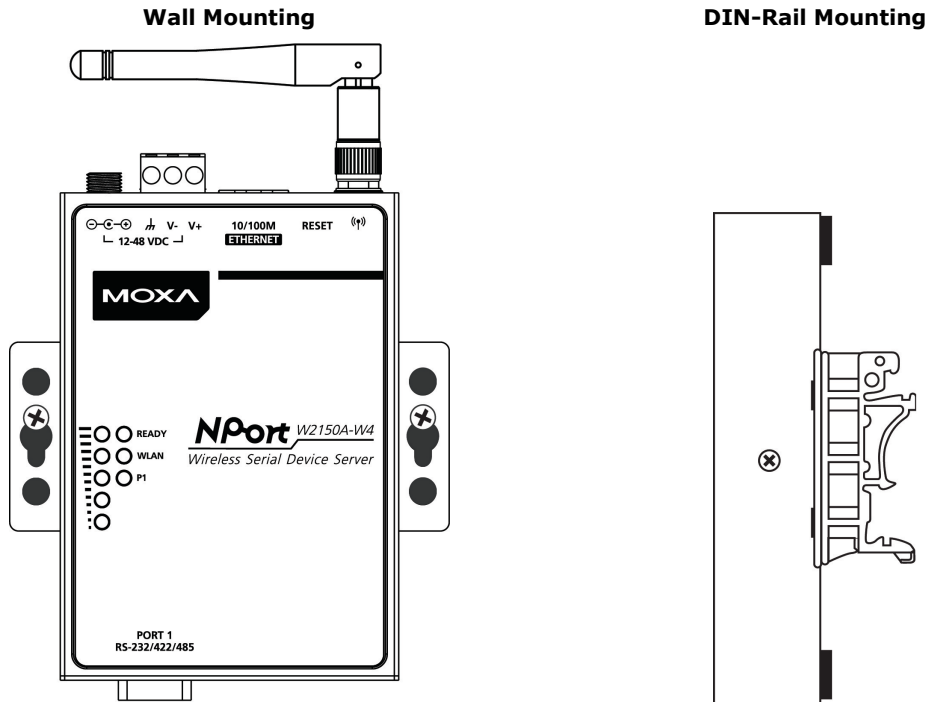

Connecting the Hardware



ATTENTION

Before connecting the hardware, follow these important wiring safety precautions:

Disconnect power source

Do not install or wire this unit or any attached devices with the power connected. Disconnect the power before installation by removing the power cord before installing and/or wiring your unit.

Follow maximum current ratings

Calculate the maximum possible current in each power wire and common wire. Observe all electrical codes dictating the maximum current allowable for each wire size.

If the current goes above the maximum ratings, the wiring could overheat, causing serious damage to your equipment.

Use caution - unit may get hot

The unit will generate heat during operation, and the casing may be too hot to touch. Take care when handling the unit. Be sure to leave adequate space for ventilation.

The following guidelines will help ensure trouble-free signal communication with the NPort.

- Use separate paths to route wiring for power and devices to avoid interference. Do not run signal or communication wiring and power wiring in the same wire conduit. The rule of thumb is that wiring that shares similar electrical characteristics can be bundled together.
- If power wiring and device wiring paths must cross, make sure the wires are perpendicular at the intersection point.
- Keep input wiring and output wiring separately.
- Label all wiring to each device in the system for easier testing and troubleshooting

Connecting to the Network

Use the supplied Ethernet cable to connect the NPort to your Ethernet network. If the cable is properly connected, the NPort will indicate a valid connection to the Ethernet as follows:

- A green Ethernet LED indicates a valid connection to a 100 Mbps Ethernet network.
- An orange Ethernet LED indicates a valid connection to a 10 Mbps Ethernet network.
- A flashing Ethernet LED indicates that Ethernet packets are being transmitted or received.

Connecting the Power

Connect the VDC power line (12 to 48 V) to the NPort's power jack or terminal block (recommended for only one connection at a time). If power is properly connected, the "Ready" LED will initially glow red. When the system is ready, the "Ready" LED will turn green.

Connecting to a Serial Device

Use a serial cable to connect your serial device to a serial port on the NPort.

3. Initial IP Configuration

Overview

This chapter presents several ways to assign the NPort's IP address for the first time. Please refer to Chapter 2 for instructions on connecting to the network.

The web console is the recommended method for configuring the NPort. Please refer to Chapter 5 and 6 for details on using the web console for configuration.



ATTENTION

The LAN and WLAN interfaces cannot be used at the same time if you don't enable the Ethernet Bridge mode (please refer to Chapter 7 for more details). If the Ethernet link is active, then WLAN connections will be disabled. If the WLAN connection is active, then the Ethernet link will be disabled.



ATTENTION

Make sure that the Ethernet cable is connected before powering up the NPort.

Factory Default IP Settings

Network Interface	IP Configuration	IP Address	Netmask
LAN	Static	192.168.126.254	255.255.255.0
WLAN	Static	192.168.127.254	255.255.255.0

If your NPort is configured to get its IP settings from a DHCP server but cannot get a response, it will use the factory default IP address and netmask.



ATTENTION

If you forget the IP address of your NPort, you can look it up using the Device Search Utility (DSU). After the Device Search Utility (DSU) has found all NPorts on the network, each unit will be listed with its IP address. Please refer to Chapter 11 for additional information on using the Device Search Utility (DSU).

Using the Telnet Console to an Assign IP Address

1. Select **Command Prompt...** from the Windows Start menu.
2. Enter **telnet 192.168.126.254** (the NPort's default IP address) and click **[OK]**.

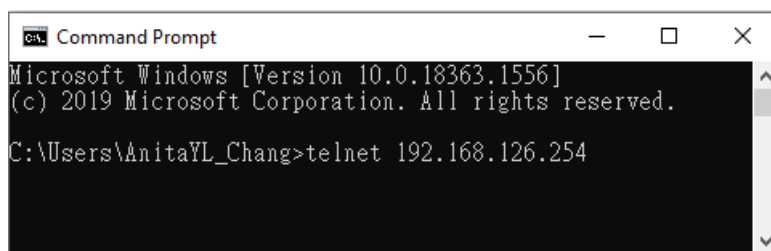

3. Enter your login account and password, then press **ENTER**.

(Default login is **admin** and password is **moxa**.)

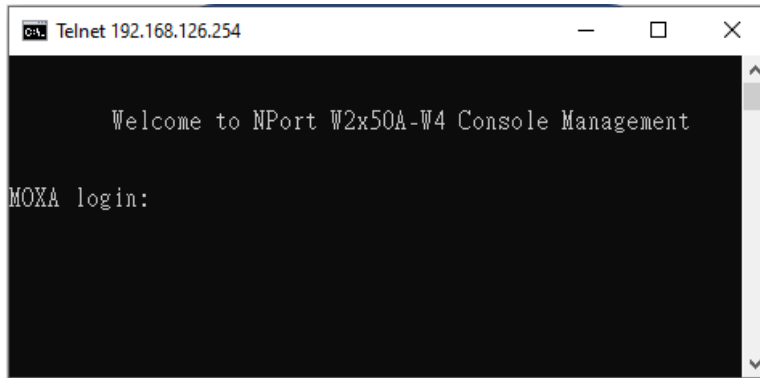

4. You will login to the **Overview** page.

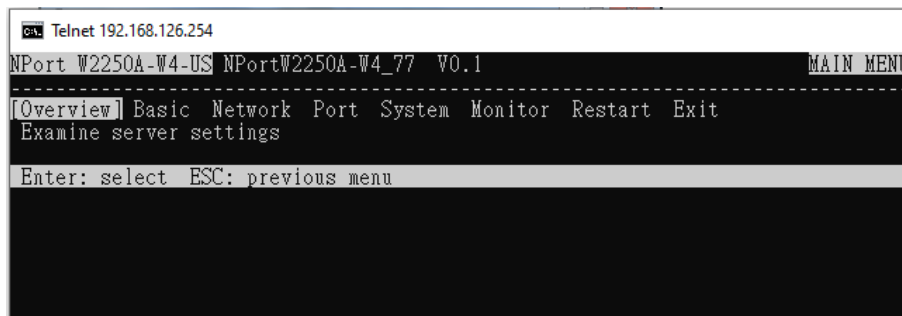

5. Press **N** or use the cursor keys to select **Network** and press **ENTER**.

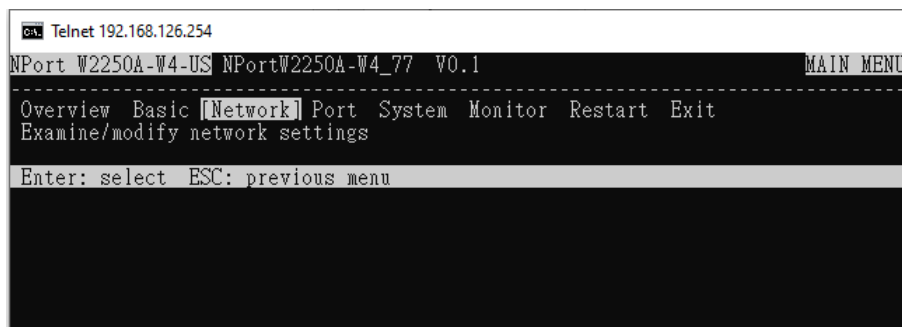

6. Press **E** or use the cursor keys to select **Ethernet** and press **ENTER**.

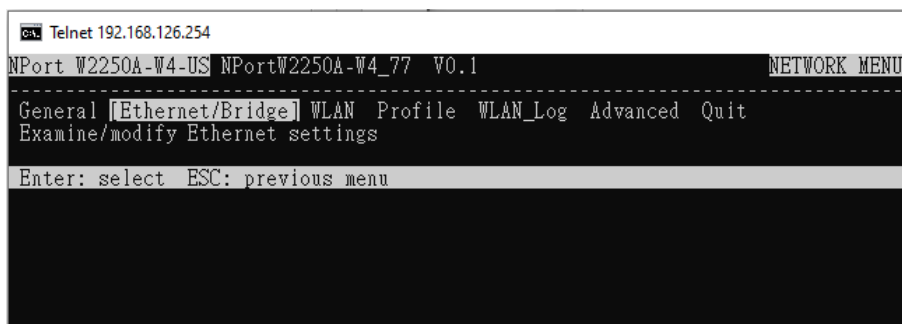

- Use the cursor keys to navigate between the different fields. For **IP address**, **Netmask**, and **Gateway**, enter the desired values directly. For **IP configuration**, **LAN speed**, and **Ethernet bridge**, press **ENTER** to open a submenu and select between the available options.

```
ca Telnet 192.168.126.254
NPort W2250A-W4-US NPortW2250A-W4_77 V0.1
-----
General [Ethernet/Bridge] WLAN Profile WLAN_Log Advanced Quit
Examine/modify Ethernet settings
ESC: back to menu Enter: select

IP configuration          [Static]
IP address                [192.168.126.254]
Netmask                   [255.255.255.0]
Gateway                   [
Ethernet bridge           [Disable]
```

- Press **ESC** to return to the menu. When prompted, press **Y** to save the configuration changes.

```
ca Telnet 192.168.126.254
NPort W2250A-W4-US NPortW2250A-W4_77 V0.1
-----
General [Ethernet/Bridge] WLAN Profile WLAN_Log Advanced Quit
Examine/modify Ethernet settings
ESC: back to menu Enter: select

Warning !!!
You have modified the network configuration.
"System Reboot" will be performed with this setting.
Would you like to continue saving?
'Y': Yes. 'N': Discard setting.
```

- The NPort will reboot with the new IP settings. You can telnet to the new IP to login again.

```
ca Telnet 192.168.126.254
NPort W2250A-W4-US NPortW2250A-W4_77 V0.1
-----
General [Ethernet/Bridge] WLAN Profile WLAN_Log Advanced Quit
Examine/modify Ethernet settings
ESC: back to menu Enter: select

Restarting NPort W2250A-W4....
```

Using the Serial Console to an Assign IP Address

Before using the NPort's serial console, turn off the power and use a serial cable to connect the NPort console port to your computer's serial port. Port 1 on the NPort serves as the console port. Use Port 1 connecting to the console port with a serial-based terminal or terminal emulator program, such as Windows HyperTerminal. You may also download PComm Lite at www.moxa.com. The terminal type should be set as ANSI or VT100, and the serial communication parameters should be set as 19200, 8, N, 1 (19200 for baud rate, 8 for data bits, None for parity, and 1 for stop bits). As soon as the connection is open, you will be presented with a text menu displaying the NPort W2150A-W4/W2250A-W4 Series general settings. Please refer to Chapter 4 for a description of the available settings. The following instructions, we recommend using PComm Terminal Emulator, which can be downloaded free from www.moxa.com, to carry out the configuration procedure.

1. Connect your PC's serial port to the NPort's console port.
2. Open your terminal emulator program, such as Windows HyperTerminal. We recommend using PComm Terminal Emulator, which can be downloaded for free at www.moxa.com.
3. In your terminal emulator program, configure the communication parameters for the serial port on the PC. Set the parameters to **19200** for baudrate, **8** for data bits, **None** for parity, and **1** for stop bits.

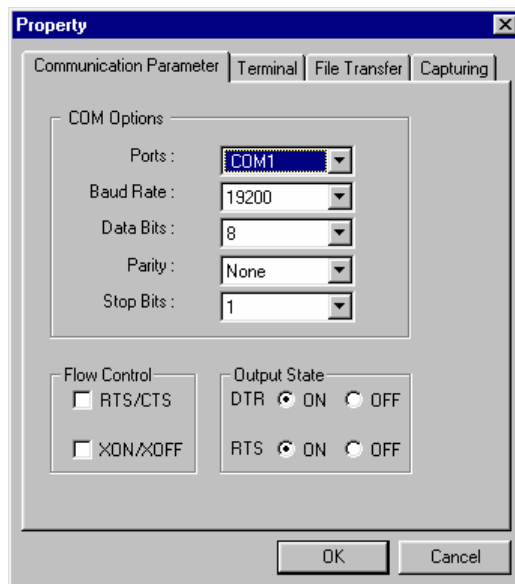

4. In your terminal emulator program, set the terminal type to **ANSI** or **VT100**. If you select **Dumb Terminal** as the terminal type, some of the console functions—especially the “Monitor” function—may not work properly.

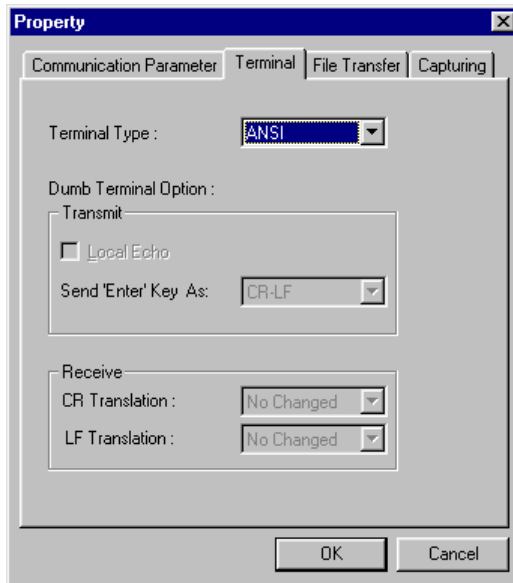

5. Hold the **grave accent** key (`) down and power up the NPort.

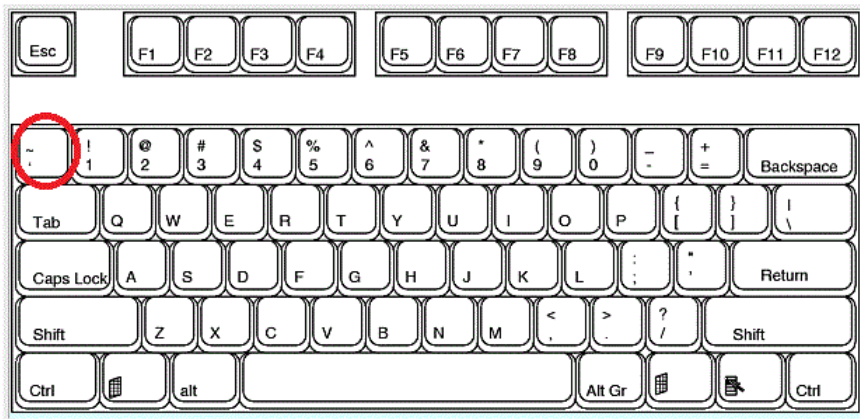

The continuous string of grave accent characters triggers the NPort to switch from data mode to console mode.

6. The serial console will open and will be functionally identical to the Telnet console. Please refer to the Telnet console section for instructions on how to navigate the console and configure the IP settings.

4. Introduction to Operation Modes

Overview

This chapter introduces the different serial port operation modes that are available on the NPort W2150A-W4/W2250A-W4 Series. Each serial port on the NPort is configured independently of the other ports, with its own serial communication parameters and operation mode. The serial port's operation mode determines how it interacts with the network, and different modes are available to encompass a wide variety of applications and devices.

Real COM and **RFC2217** modes allow serial-based software to access the NPort serial port as if it were a local serial port on a PC. These modes are appropriate when your application relies on Windows or Linux software that was originally designed for locally attached COM or TTY devices. With these modes, you can access your devices from the network using your existing COM/TTY-based software, without investing in additional software.

Three different socket modes are available for user-developed socket programs: **TCP Server**, **TCP Client**, and **UDP Server/Client**. For TCP applications, the appropriate mode depends on whether the connection will be hosted or started from the NPort serial port or from the network. The major difference between the TCP and UDP protocols is that TCP guarantees delivery of data by requiring the recipient to send an acknowledgement to the sender. UDP does not require this type of verification, making it possible to offer speedier delivery. UDP also allows multicasting of data to groups of IP addresses and would be suitable for streaming media or noncritical messaging applications, such as LED message boards.

Pair Connection Slave and **Master** modes are designed for serial-to-serial communication over Ethernet, in order to overcome traditional limitations with serial transmission distance.

In **Ethernet Modem** mode, the NPort acts as an Ethernet modem, providing a network connection to a host through the serial port.

Real COM Mode

Real COM mode works with NPort drivers that are installed on a network host. COM drivers are provided for Windows systems, and TTY drivers are provided for Linux and UNIX systems. The driver establishes a transparent connection to the attached serial device by mapping a local serial port to the NPort serial port. Real COM mode supports up to four simultaneous connections, so multiple hosts can collect data from the attached device at the same time.

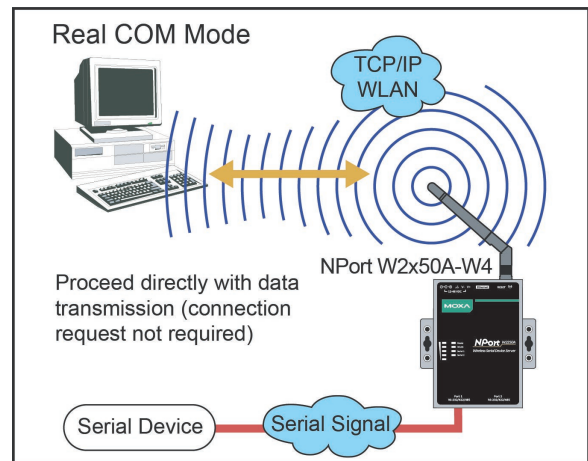

ATTENTION

Real COM drivers are installed and configured through NPort Windows Driver Manager.

Real COM mode allows you to continue using your serial communications software to access devices that are now attached to your NPort device server. On the host, the NPort Real COM driver automatically intercepts data sent to the COM port, packs it into a TCP/IP packet, and redirects it to the network. At the other end of the connection, the NPort device server accepts the Ethernet frame, unpacks the TCP/IP packet, and sends the serial data to the appropriate device.



ATTENTION

In Real COM mode, several hosts can have simultaneous access control over the NPort serial port. If necessary, you can limit access by using the NPort's Accessible IP settings. Please refer to Chapter 8 for additional information on Accessible IP settings.

RFC2217 Mode

RFC-2217 mode is similar to Real COM mode, since it relies on a driver to transparently map a virtual COM port on a host computer to a serial port on the NPort. The RFC2217 standard defines general COM port control options based on the Telnet protocol and supports one connection at a time. Third party drivers supporting RFC-2217 are widely available on the Internet and can implement virtual COM mapping.

TCP Server Mode

In TCP Server mode, the NPort serial port is assigned an IP:port address that is unique on your TCP/IP network. It waits for the host computer to establish a connection to the attached serial device. This operation mode also supports up to eight simultaneous connections, so multiple hosts can collect data from the attached device at the same time.

Data transmission proceeds as follows:

A host requests a connection to the NPort serial port.

Once the connection is established, data can be transmitted in both directions—from the host to the device, and from the device to the host.

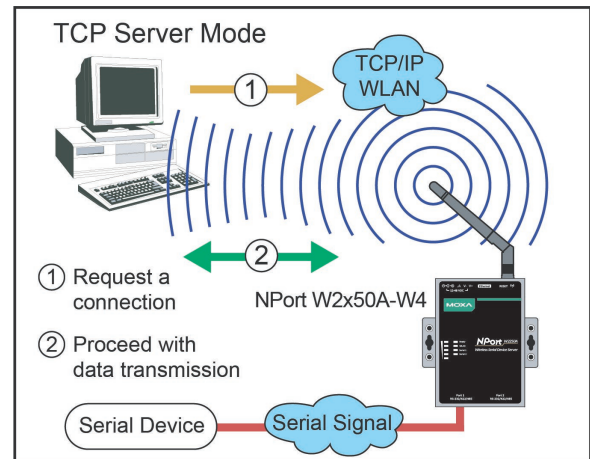

TCP Client Mode

In TCP Client mode, the NPort actively establishes a TCP connection to a specific network host when data is received from the attached serial device. After the data has been transferred, the NPort can automatically disconnect from the host computer through the Inactivity time settings. Please refer to Chapter 7 for details on these parameters.

Data transmission proceeds as follows:

The NPort requests a connection from the host.

The connection is established and data can be transmitted in both directions between the host and device.

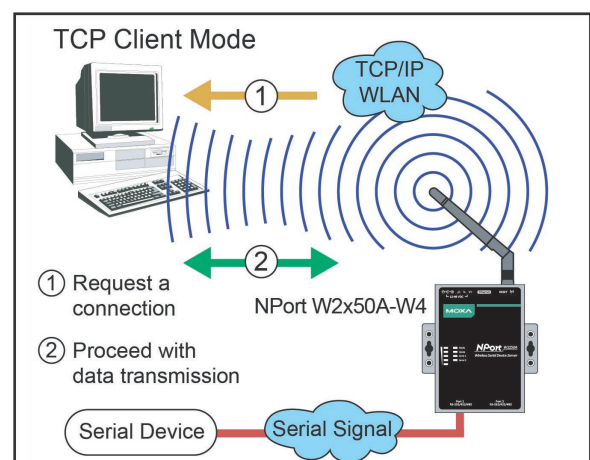

UDP Mode

UDP is similar to TCP but is faster and more efficient. Data can be broadcast to or received from multiple network hosts. However, UDP does not support verification of data and would not be suitable for applications where data integrity is critical. It is ideal for message display applications.

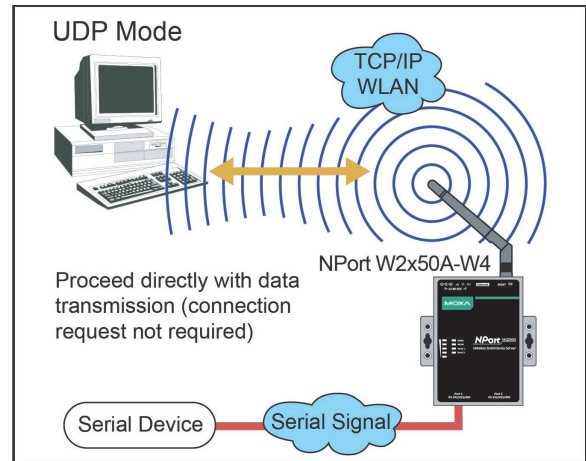

Pair Connection Modes

Pair Connection Master and Slave modes connect two NPort device servers over a network for serial-to-serial communication. A device attached to one NPort can then communicate transparently to a device attached to the other NPort, as if a serial cable connected the two devices. Both data and modem control signals are exchanged, except for DCD signals. This can overcome traditional limitations with serial communication distance and introduce many new possibilities for serial-based device control.

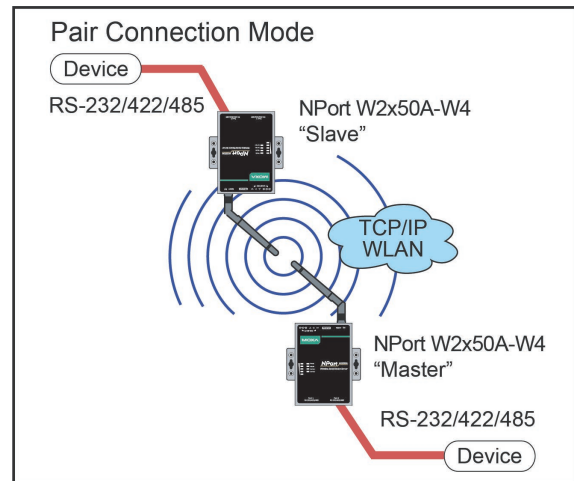

Ethernet Modem Mode

Ethernet Modem mode is designed for use with legacy operating systems, such as MS-DOS, that do not support TCP/IP Ethernet. By connecting the properly configured NPort serial port to the MS-DOS computer's serial port, it is possible to use legacy software to transmit data over the Ethernet when the software was originally designed to transmit data over a modem.

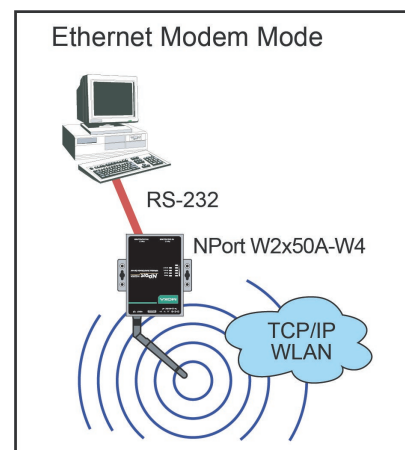

Reverse Terminal Mode

Reverse terminal applications are similar to terminal applications, as they use the NPort W2x50A-W4 to manage the connection between a terminal and a server. The difference is that with reverse terminal applications; the terminal is connected through the network and the server is connected through the serial port, rather than the other way around. In practice, a reverse terminal session typically involves a network administrator telnetting to a device that has a dedicated serial console port used specifically for configuration.

For example, many routers, switches, UPS units, and other devices (including the NPort W2x50A-W4) have Console/AUX or COM ports to which a terminal can be physically connected for console management. With the NPort W2x50A-W4, the device's console port can be connected to a serial port on the NPort W2x50A-W4, allowing a network administrator to telnet to the device remotely through the network. Although modern network equipment allows other options for remote configuration through the network, there are situations in which it is necessary or desirable to configure a device by serial console (e.g., for security reasons, when using older-generation equipment, or as a backup configuration method when the network is down).

NPort W2x50A-W4 reverse terminal modes allow the use of the NPort W2x50A-W4 User Table or a RADIUS server for identity verification purposes.

5. Installing and Configuring the Software

Overview

This chapter describes how to install and use the NPort Windows Driver Manager, the Device Search Utility (DSU), and NPort Linux and UNIX drivers. You may download these items from Moxa's website that is provided with the NPort W2150A-W4/W2250A-W4 Series.

NPort Windows Driver Manager is a utility that installs and manages NPort COM drivers for COM mapping. The **Device Search Utility (DSU)** is a utility for the management of NPort device servers over the network. You may also use the Device Search Utility (DSU) to upgrade the firmware.

Device Search Utility (DSU)

Installing the DSU

1. Download the DSU from Moxa's website:
<https://www.moxa.com/support/download.aspx?type=support&id=10137>
You may double click on the executable file. Once the program runs, click **Yes** to proceed.
2. The installation wizard will open. Click **Next** to proceed.

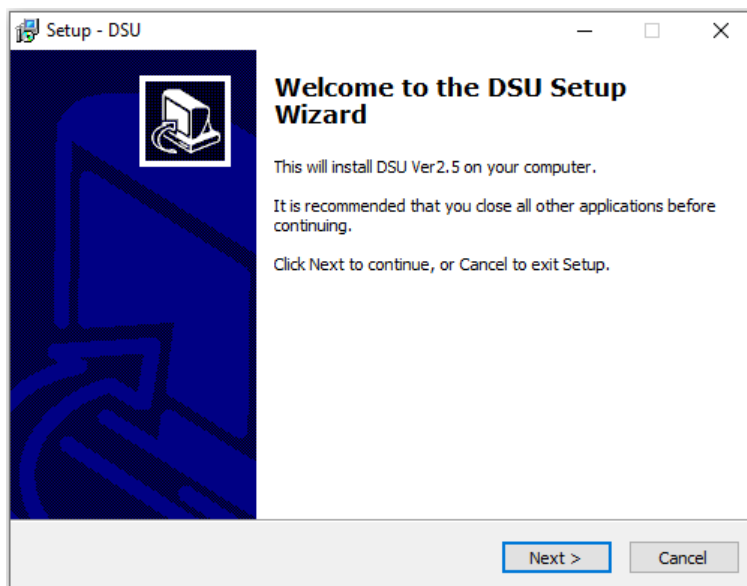

3. Select a destination location and click **Next** to proceed.

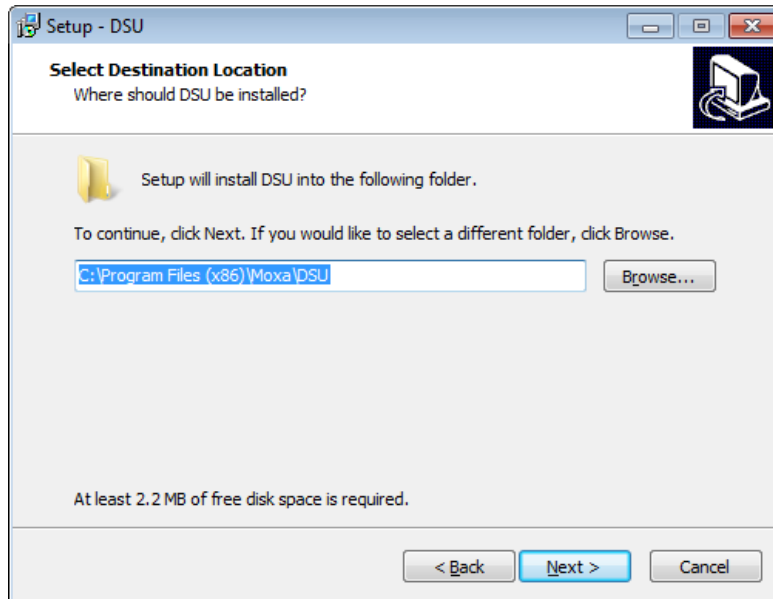

4. Show if you wish to create a desktop icon and click **Next** to proceed.

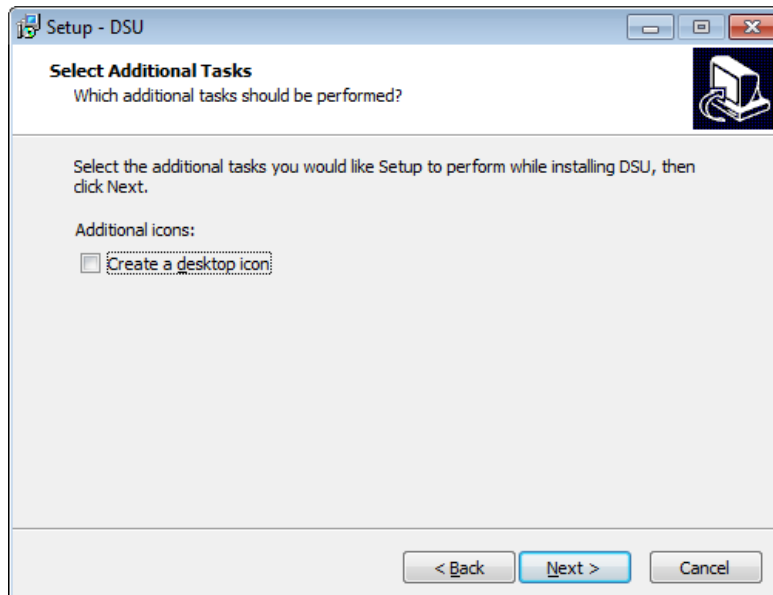

5. Verify the installation parameters and click Install to proceed.

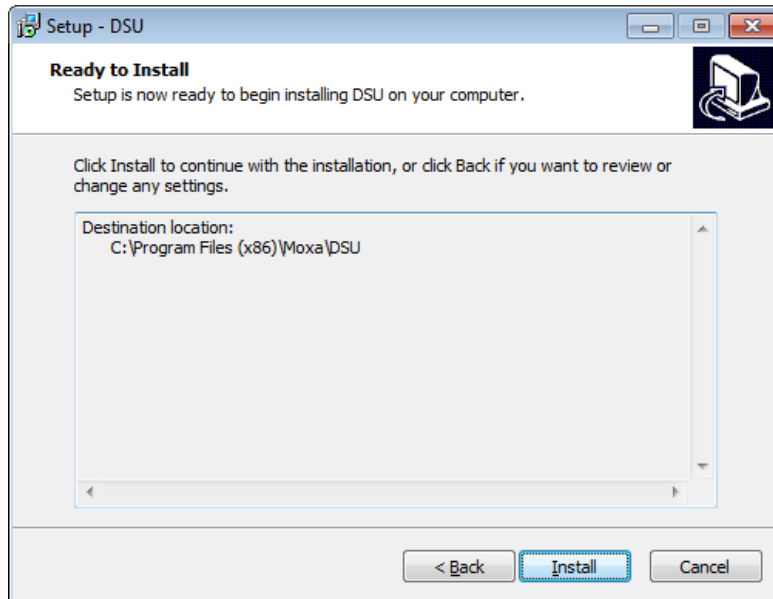

6. The wizard will begin installing the files. After the files have been installed, click **Finish** to complete the installation.

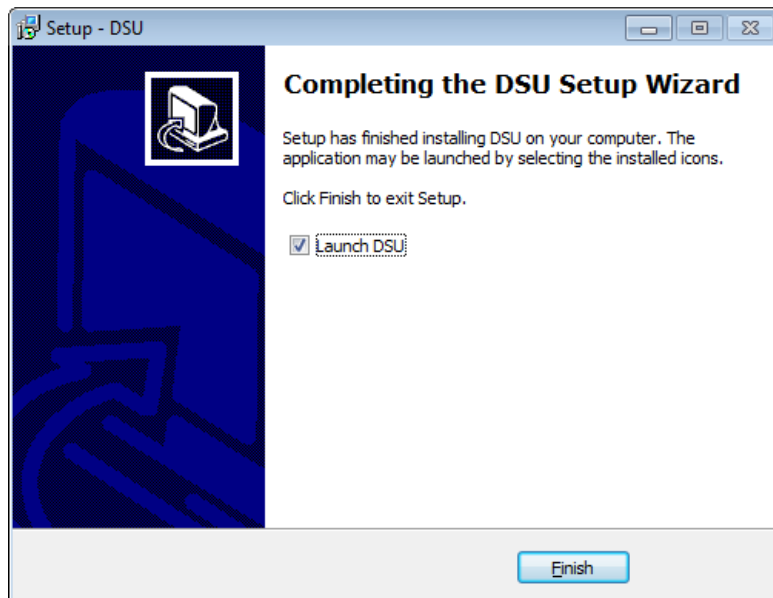

Finding NPort Device Servers on a Network

You can use the Device Search Utility (DSU) to look up or change the IP address of any NPort device server on the network. Since the utility searches for devices based on their MAC address rather than IP address, all NPort units that are connected to the LAN will be located, regardless of whether they are part of the same subnet as the host.

1. In the Device Search Utility (DSU), click **Search** on the main toolbar.

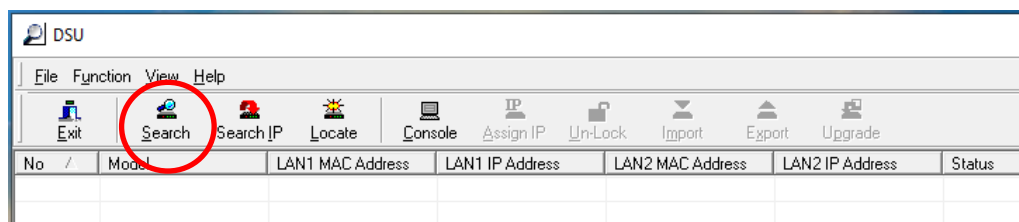

- The utility will search for NPort device servers.

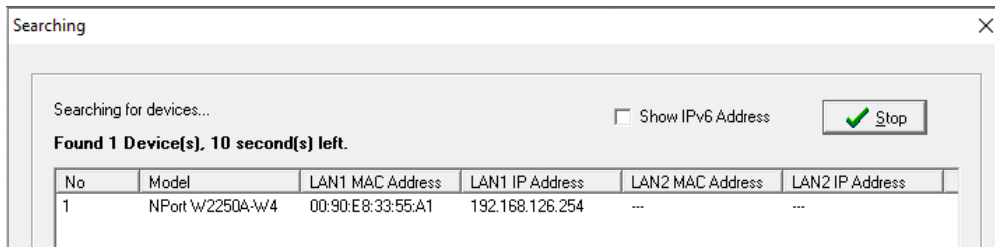

- When the search is complete, the NPort units that were found will be listed in the main window.

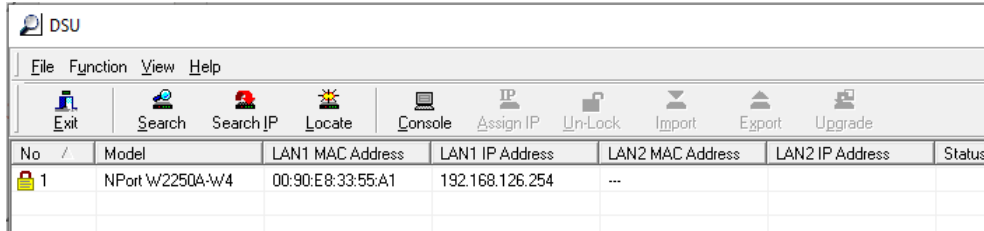

Unlock Device Servers

- Select the device and click **Un-Lock**.

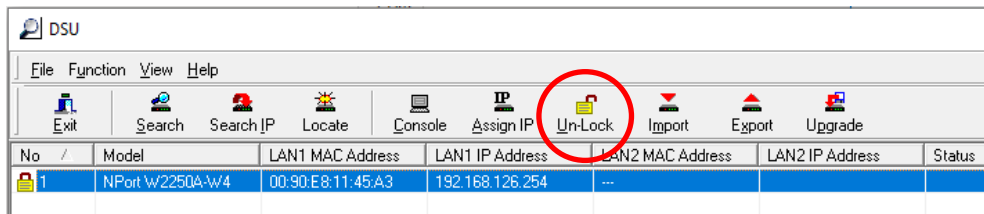

- Enter password and click **OK**.

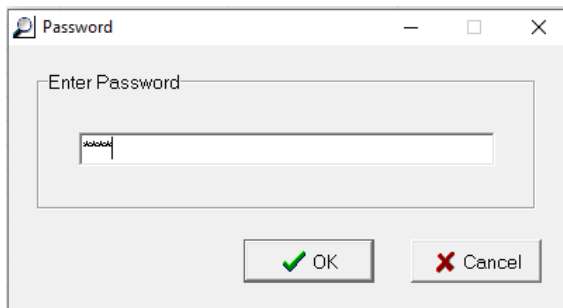

Modifying NPort IP Addresses

- Once the Device Search Utility (DSU) has found NPort device servers on the LAN, you can change any unit's IP address. Select the desired NPort in the main window and click **Assign IP** on the main toolbar. This will change the IP address for the active network connection (LAN or WLAN).

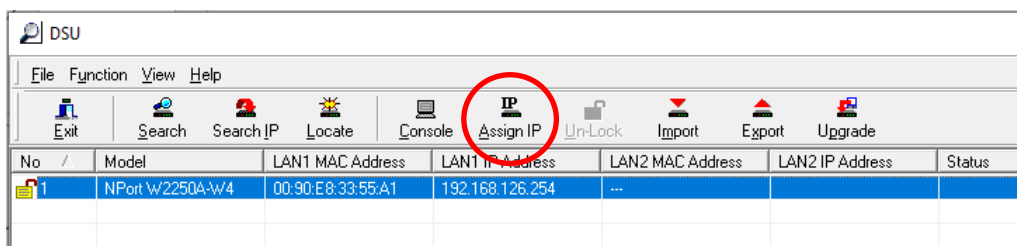

2. Enter the new IP address and netmask. If multiple units were selected, you may assign addresses sequentially by clicking **Assign IP Sequentially**. Click **OK** to proceed.

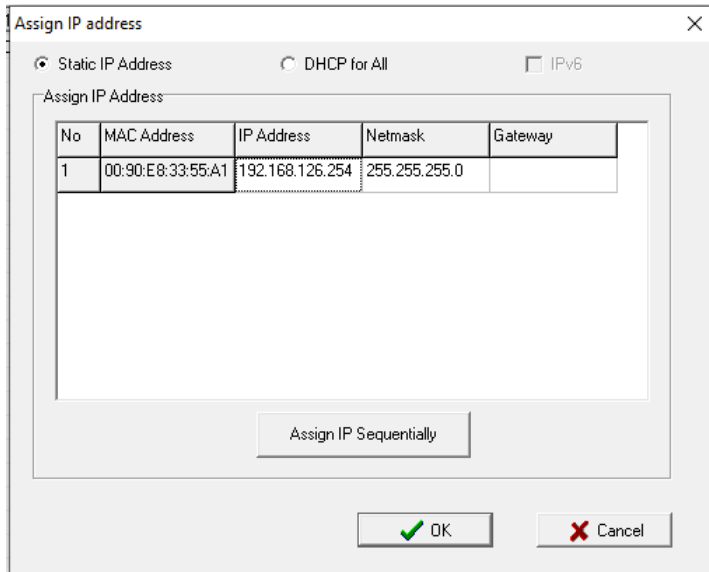

3. The selected NPort will be restarted by the Device Search Utility (DSU) with the new IP address.

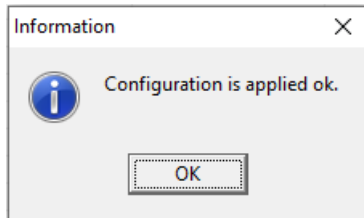

Upgrading NPort Firmware

1. Once the Device Search Utility (DSU) has found NPort device servers on the LAN, you can upgrade any unit's firmware. Right-click the desired NPort in the main window and select **Upgrade**.

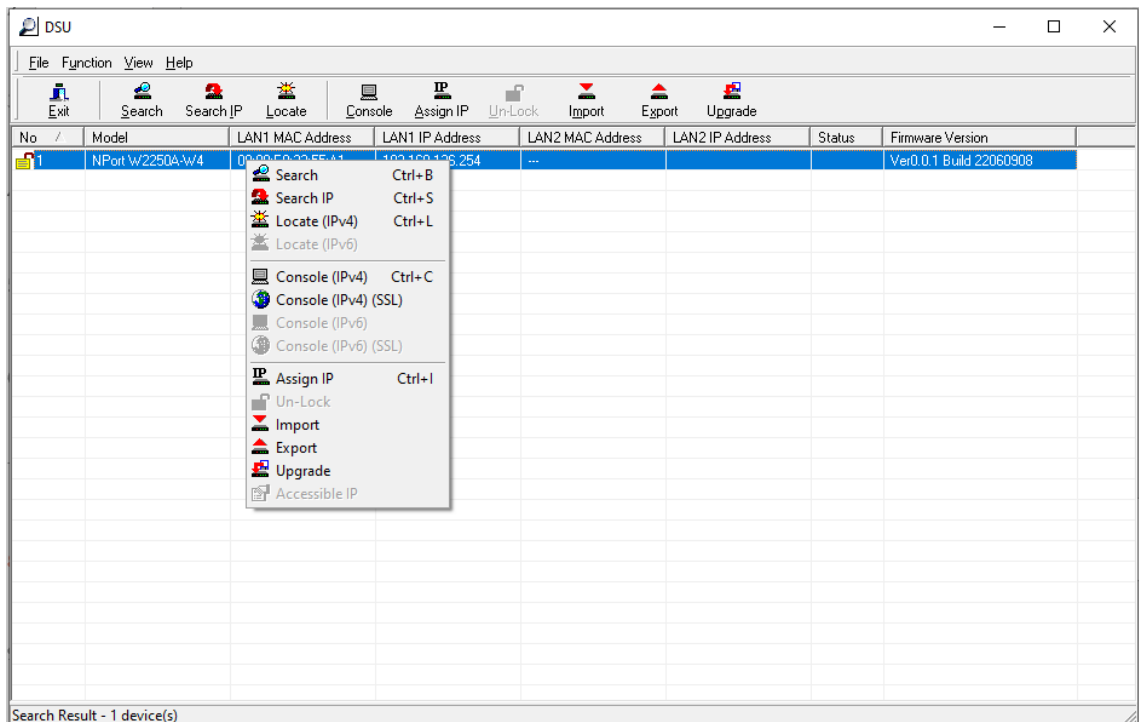

2. Select the new firmware file and click **OK** to proceed. To get the latest firmware for the NPort W2150A-W4/W2250A-W4 Series, visit www.moxa.com.

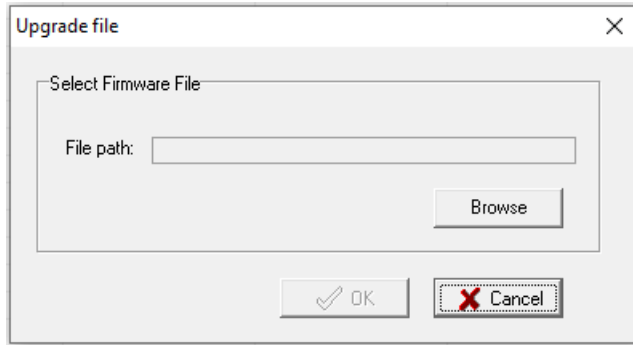

3. The utility will begin upgrading the firmware for the selected unit. Do not disconnect or power off the unit while the firmware is being upgraded.

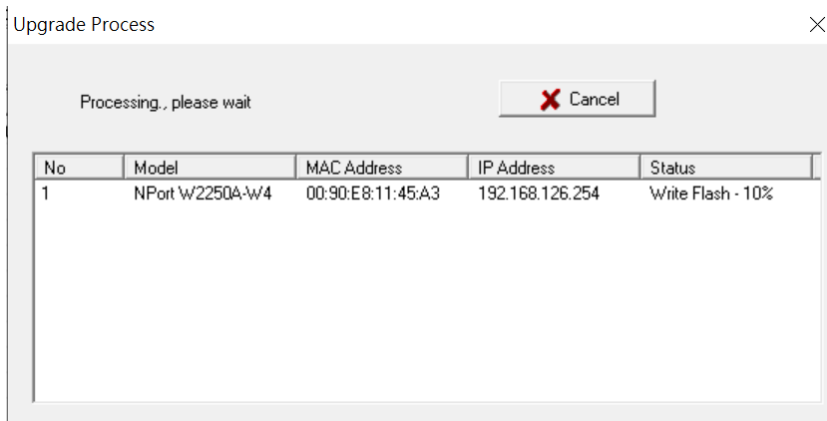

4. When the displayed status is OK, click **Close** to complete the process.

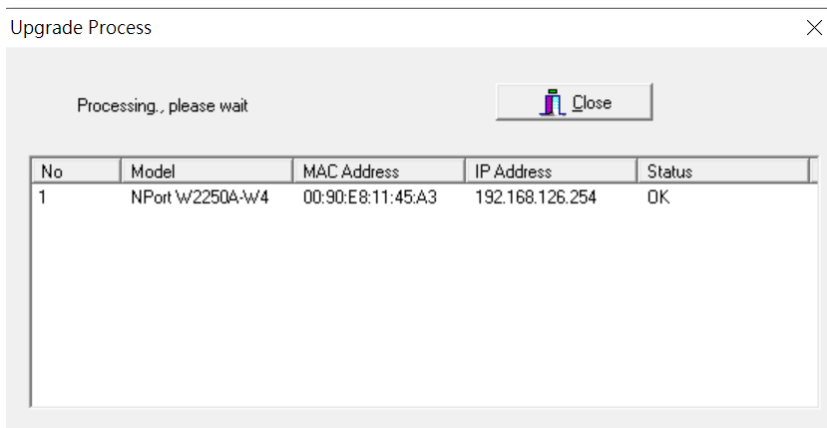

ATTENTION

The Device Search Utility (DSU) supports upgrading the firmware of multiple units simultaneously if each unit is the same model. Hold down the CTRL key to add additional units to your selection; hold down the SHIFT key to select a block of units.

NPort Windows Driver Manager

NPort Windows Driver Manager installs remote NPort serial ports as new COM ports on your Windows PC. When the drivers are installed and configured, devices that are attached to serial ports on the NPort will be treated as if they were attached to your PC's own COM ports. The NPort serial port must be configured for Real COM mode when being mapped to a COM port.

Installing NPort Windows Driver Manager

1. Download the NPort Windows Driver Manager from Moxa website:
<https://www.moxa.com/support/download.aspx?type=support&id=974>
You may double click on the executable file. Once the installation program runs, click **[Yes]** to proceed.

2. The installation wizard will open. Click **Next** to proceed.
Windows Driver Manager version 4.0: Windows 11/server 2022
Windows Driver Manager version 3.x: Windows 7~10

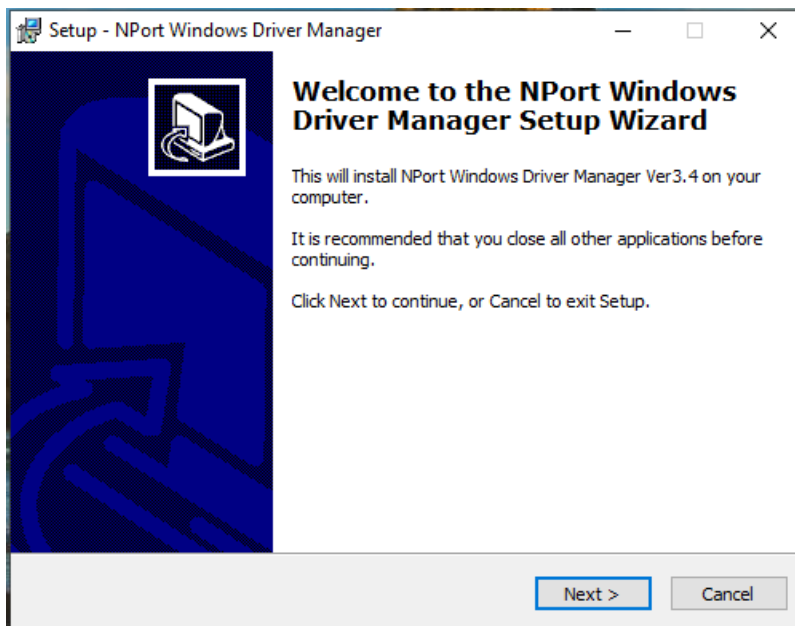

3. Read and select **I accept the agreement**. Click **Next** to proceed.

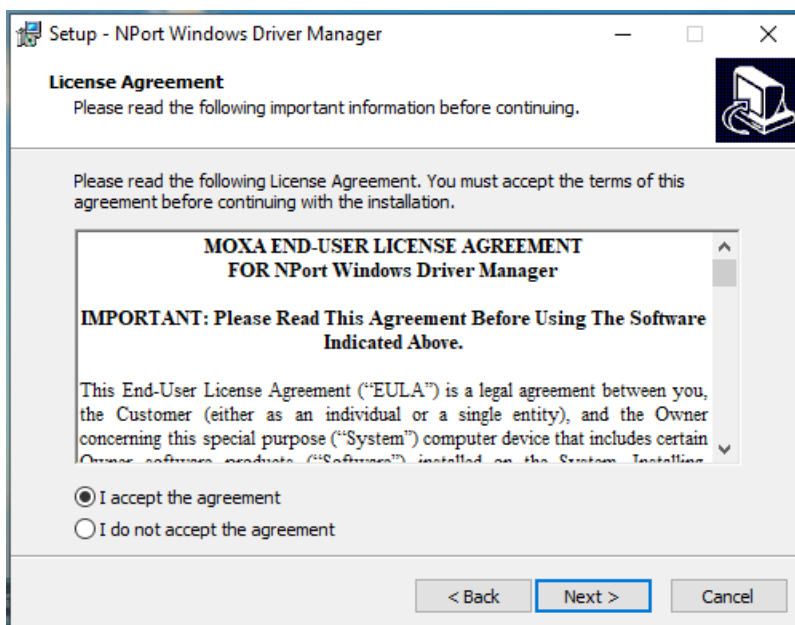

4. Select a destination location and click Next to proceed.

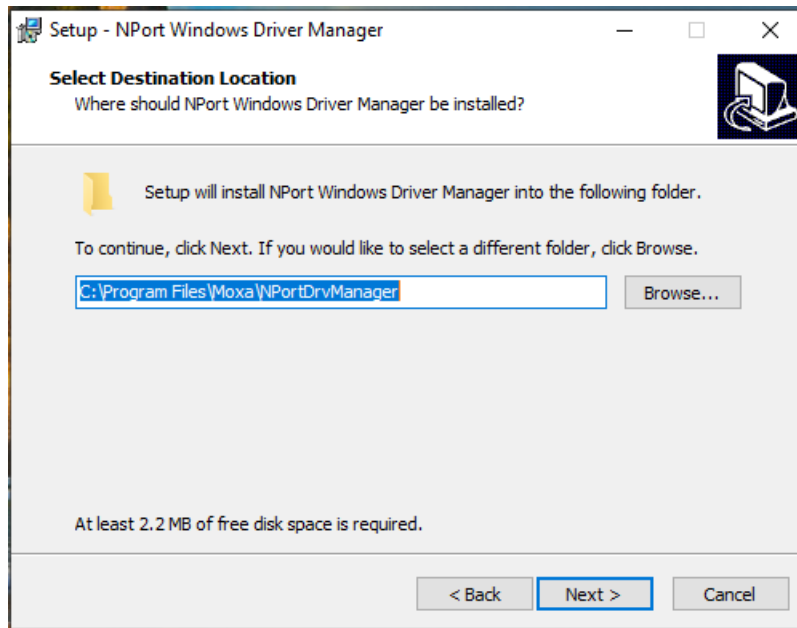

5. Select a folder for the program shortcuts and click **Next** to proceed.

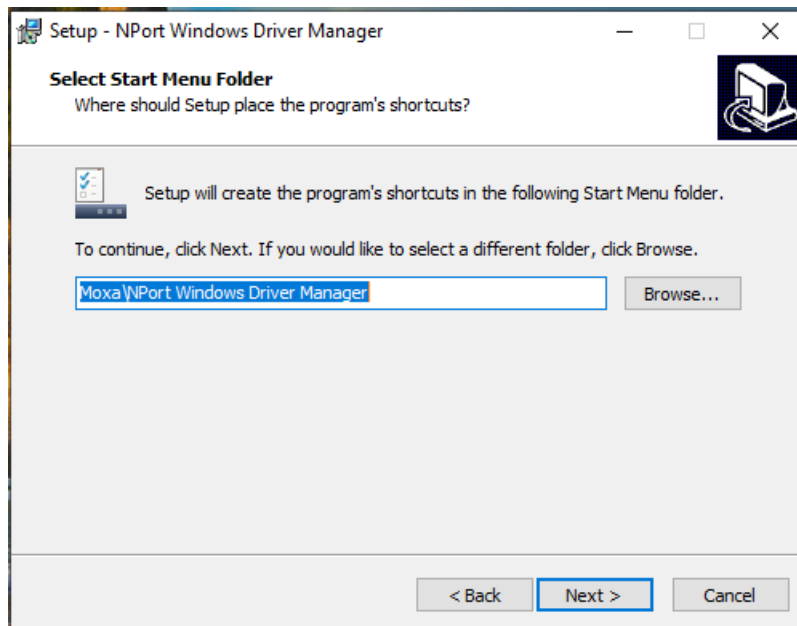

6. Verify the installation parameters and click Install to proceed.

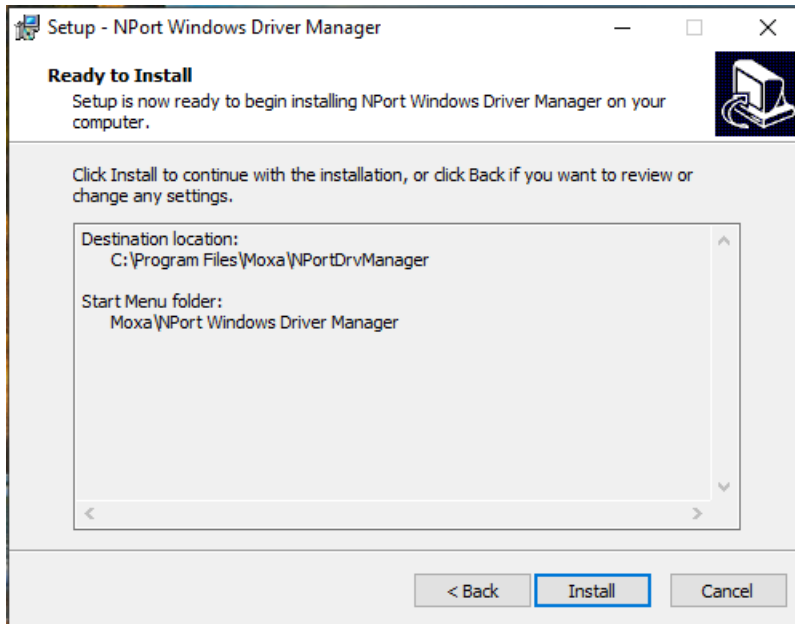

7. If you see a warning that the software has not passed Windows Logo testing, click **Continue Anyway** to proceed.

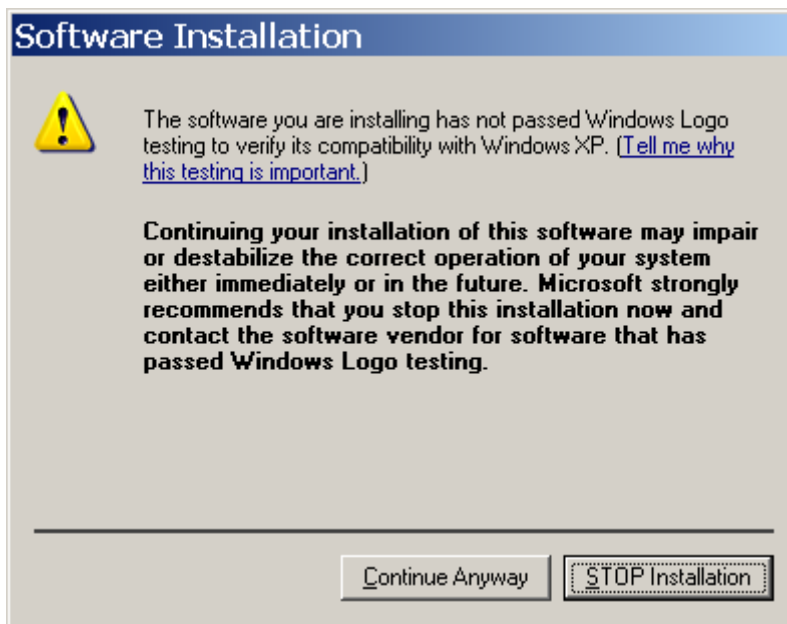

- The wizard will begin installing the files. When the files have been installed, click **Finish** to complete the installation.

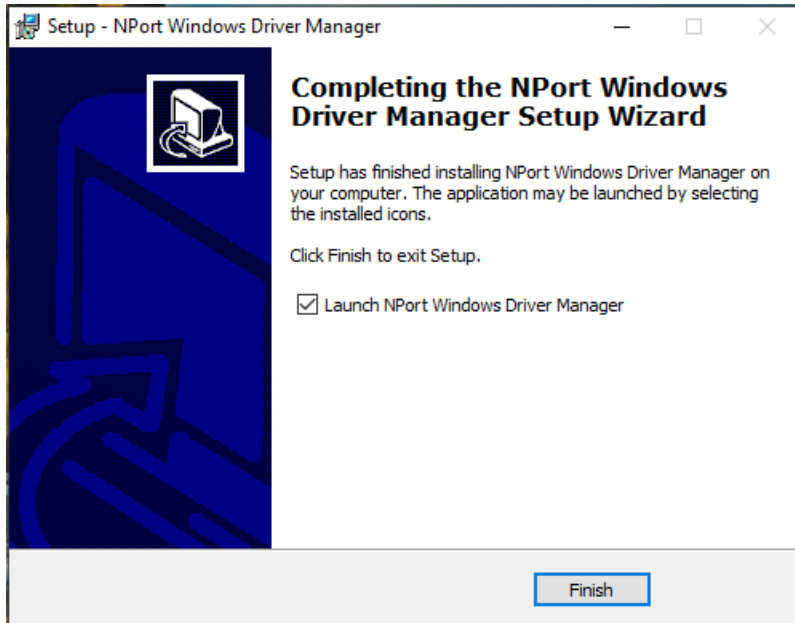

Adding Mapped Serial Ports

NPort Windows Driver Manager adds a COM port to your PC that is mapped to an NPort serial port. The destination NPort serial port must be set to Real COM mode.

- In **NPort Windows Driver Manager**, click **Add** on the main toolbar.

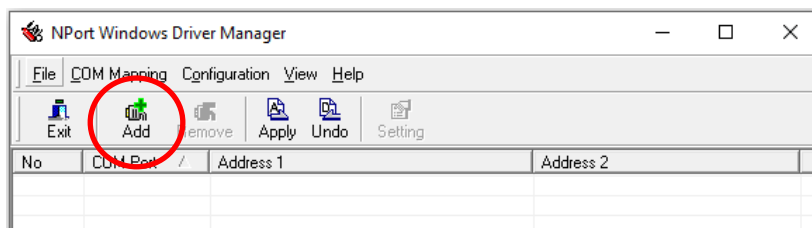

- Click **Search** to search the network for NPort device servers. In the list of NPort device servers that were found, select the unit(s) that you will use for COM mapping and click **OK**.

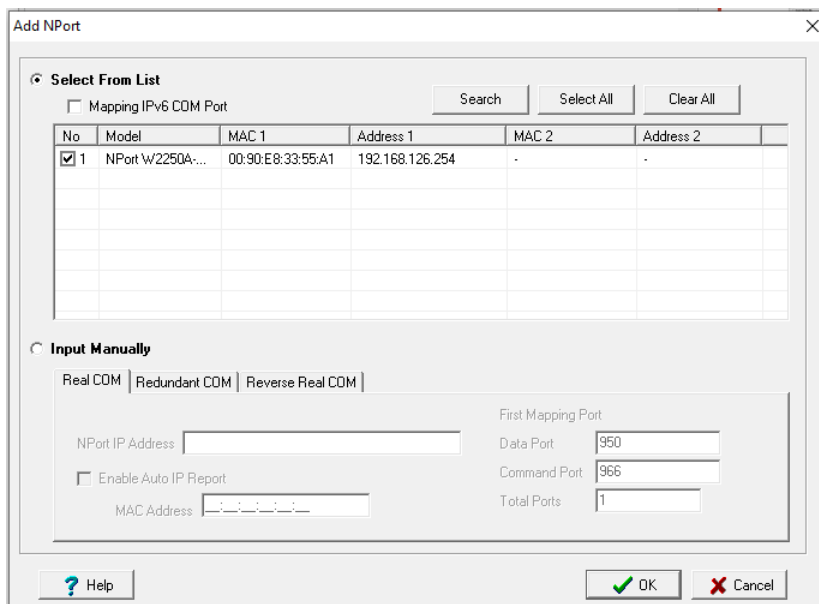

- Activated COM ports will be listed in black; COM ports that have not been activated will be listed in blue. Once a COM port has been activated, the host computer will communicate with the new COM port as if it were physically attached. Since the COM mappings are stored in the host system registry, they will still be in effect if the PC is restarted or if Windows Driver Manager is closed.

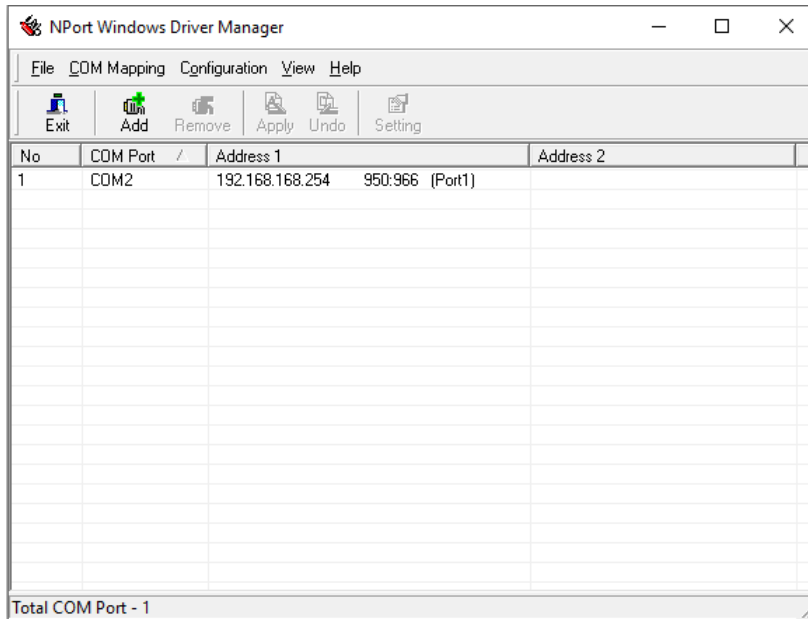

Configuring Mapped Serial Ports

- To change the settings of a mapped serial port, select the desired port(s) and click **Setting** on the main toolbar.

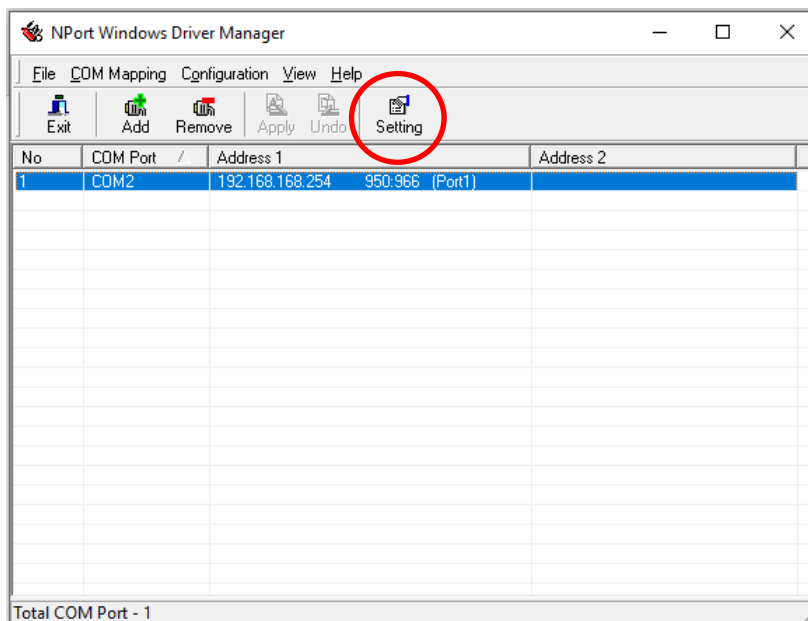

- On the **Basic Setting** tab, select the **COM Number** that will be assigned to the serial port. If you have selected multiple ports, you can assign COM numbers automatically in sequential order by selecting the **Auto Enumerating COM Number for Selected Ports** function.

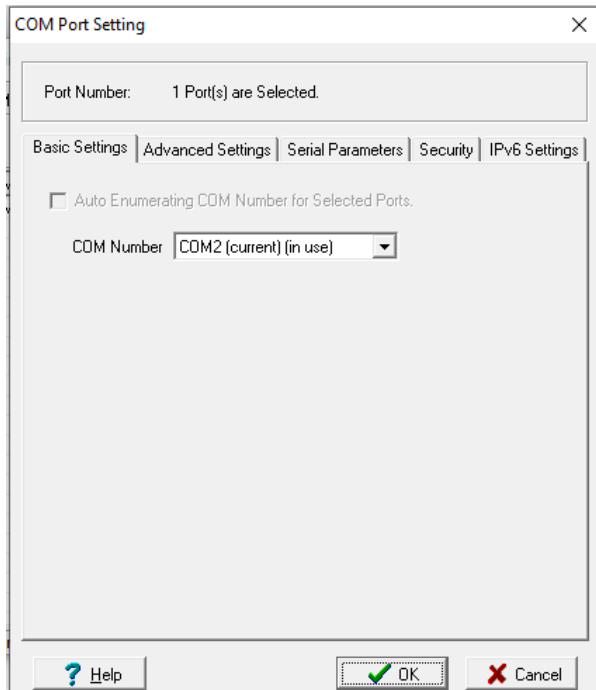

- On the **Advanced Setting** tab, configure **Tx Mode**, **FIFO**, and **Fast Flush**.

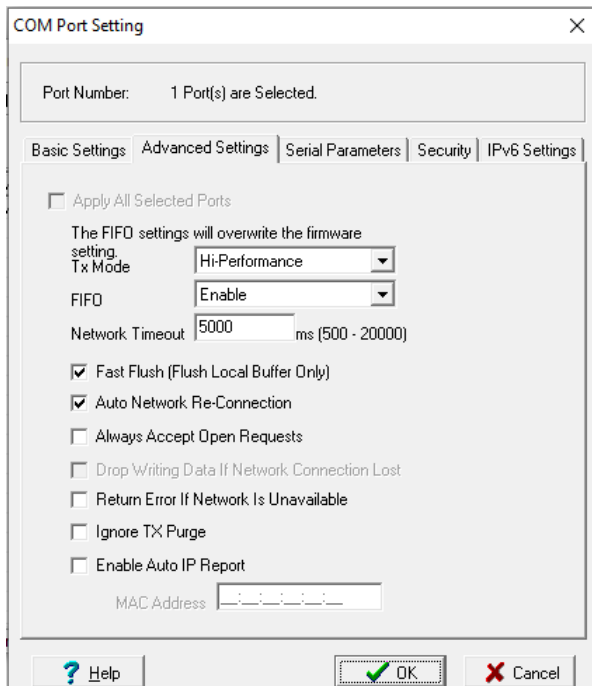

Tx Mode: In Hi-Performance mode, the driver immediately issues a "Tx Empty" response to the program after sending data to the NPort. In Classical mode, the driver sends the "Tx Empty" response after confirmation is received from the NPort. Classical mode is recommended if you want to ensure that all data is sent out before further processing.

FIFO: This tells the driver whether or not to use the FIFO.

Network Timeout: You can use this option to prevent blocking if the target NPort is unavailable.

Fast Flush: When enabled, the driver flushes only the local buffer on the host for a Win32 PurgeComm() function call. When disabled, both the local and remote buffers are flushed. If your application uses PurgeComm() and performance seems sluggish, try enabling Fast Flush.

Auto Network Re-Connection: With this option enabled, the driver will repeatedly attempt to re-establish the TCP connection if the NPort does not respond to background “check-alive” packets

Always Accept Open Requests: When enabled, the NPort driver will always accept requests to open a virtual COM port, even if communications with the device can not be established. With this option, the NPort driver will open a virtual COM port on the system even if the port is blocked or the Ethernet connection is disabled. If this is the case, the connected device will not receive and transmit data even though the system has opened a virtual COM port.

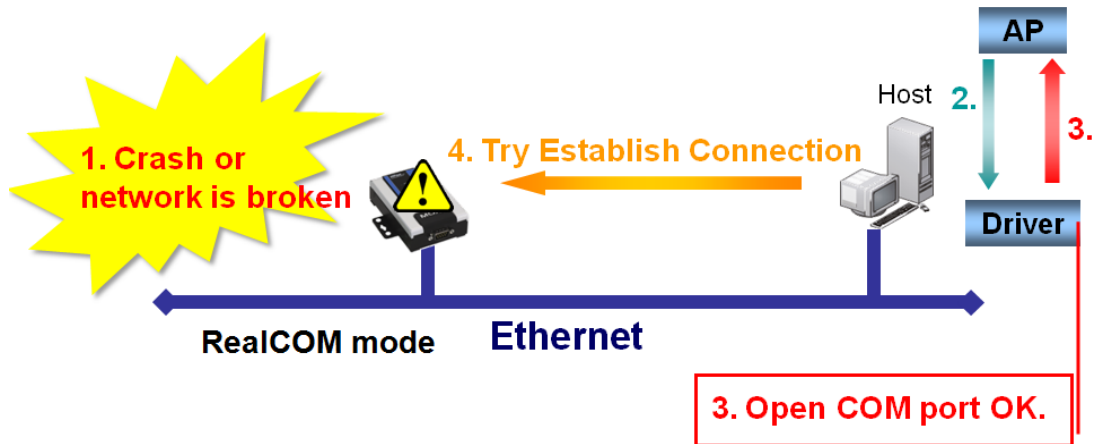

Drop Writing Data if Network Connection is Lost: This function will assure the data to be kept in the buffer or dropped when network connection is lost. The buffer size is 4 KBytes.

Return error if network is unavailable: If this option is disabled, the driver will not return any error even when a connection cannot be established to the NPort. With this option enabled, calling the Win32 Comm function will cause the error return code “STATUS_NETWORK_UNREACHABLE” when a connection cannot be established to the NPort. This usually means that your host’s network connection is down, perhaps because of a cable being disconnected. However, if you can reach other network devices, maybe the NPort is not powered on or is disconnected. Note that **Auto Network Re-Connection** must be enabled in order to use this function.

Ignore TX Purge: Applications can use the Win32 API PurgeComm to clear the output buffer. Outstanding overlapping write operations will be terminated. Select the **Ignore TX Purge** checkbox to ignore the effect on output data.

4. On the **Serial Parameters** tab, specify the communication settings that the host will use when opening the COM port.

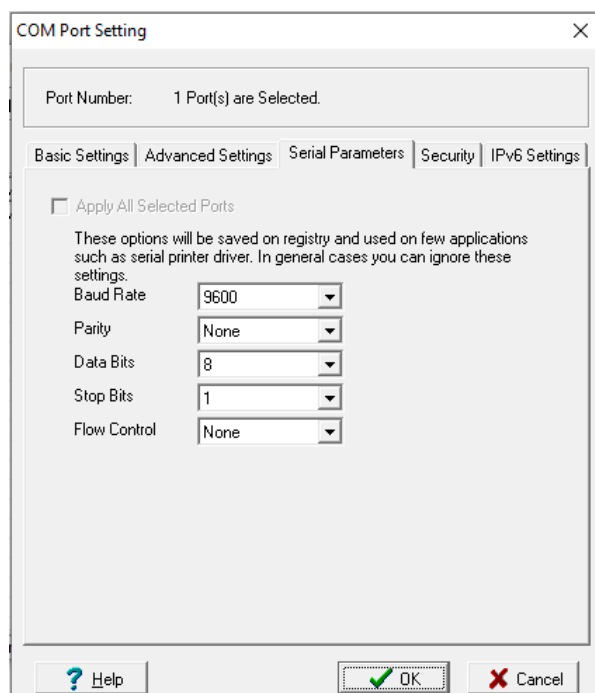

- (NPort 6000 models only) On the **Security** tab, select the **Enable Data Encryption** option to enable data to be encrypted when transmitted over the COM ports. After selecting the encryption option, select the **Keep connection** option to encrypt COM port communications immediately without restarting the COM ports. This may speed up opening and closing of the COM port for your host, but it also causes your host to tie up the NPort serial port so other hosts cannot use it.

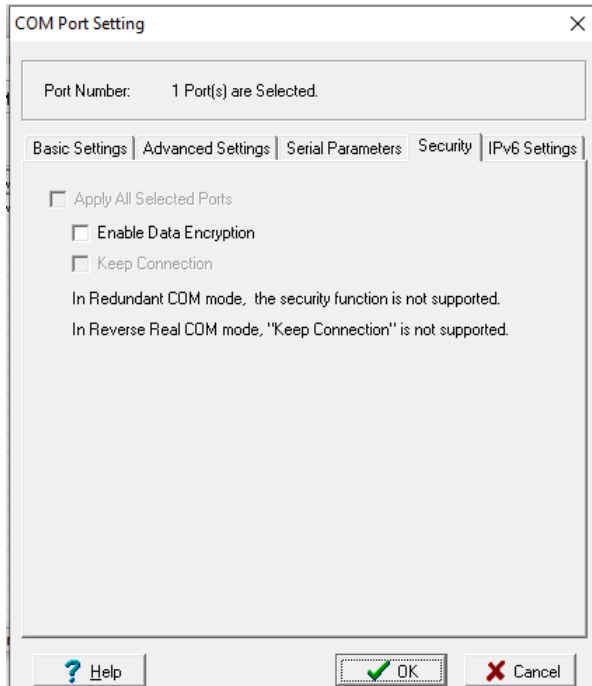

- On the IPv6 Setting tab, interface 1 and 2 can change.

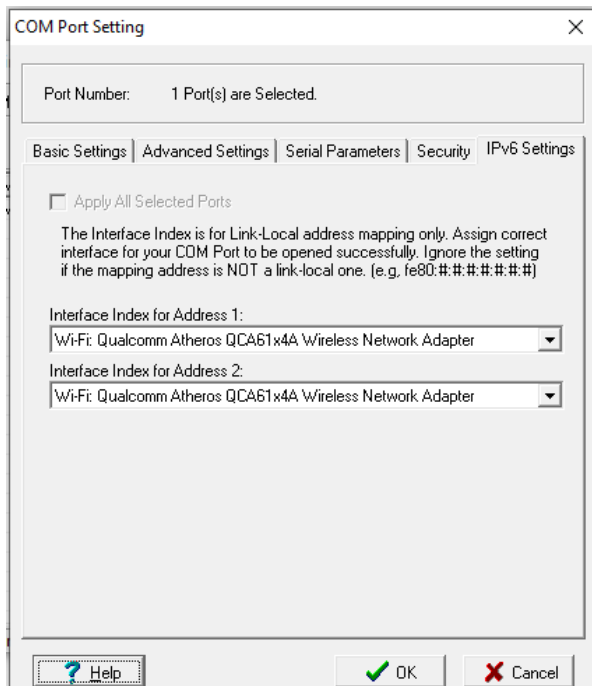

- Click **OK** when you have finished configuring the COM port.

8. To save all COM mapping settings to a text file, right-click a COM port and select **Export** in the context menu. After the settings have been exported to a file, they can be imported on another host.

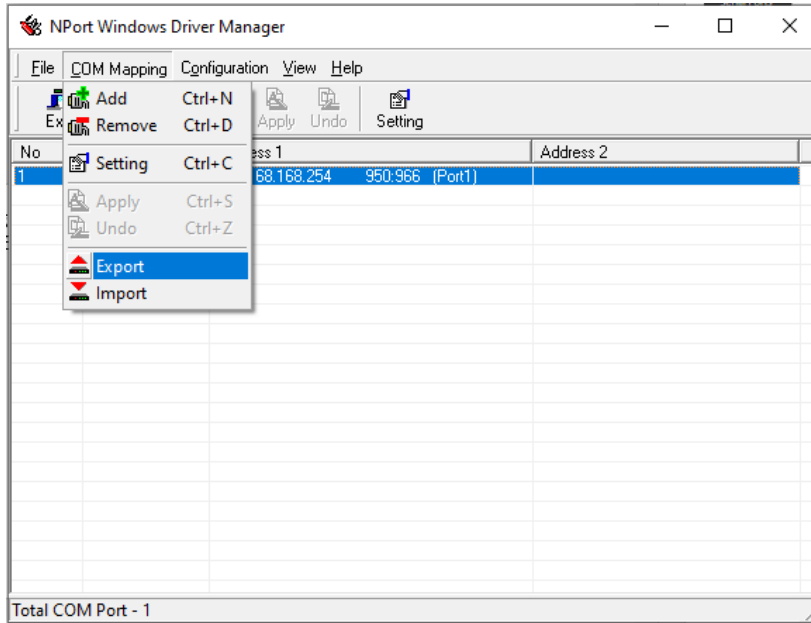

Command-Line Installation/Removal

For NPort Windows Driver Manager v1.19 and above, it comes with command line script tool—npcli.exe for installation, removal of the driver and capability of configuring NPort driver functions.

After successfully installing NPort Windows Driver Manager v1.19 (or above), the default file path is C:\Program Files\NPortDrvManager as shown below. The main files that support the NPort command line tool are npcli.exe and GIdMap.dat. You may move these two files to your preferred location.

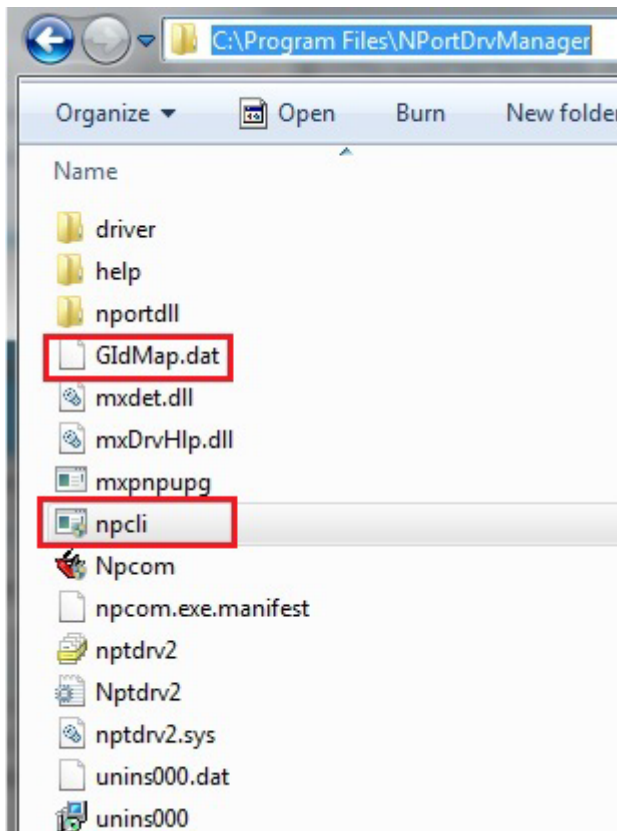

Once NPort Windows Driver Manager v1.19 (or above) is installed, call up the cmd screen on your computer. Change the directory to the drive where you placed the above two files.

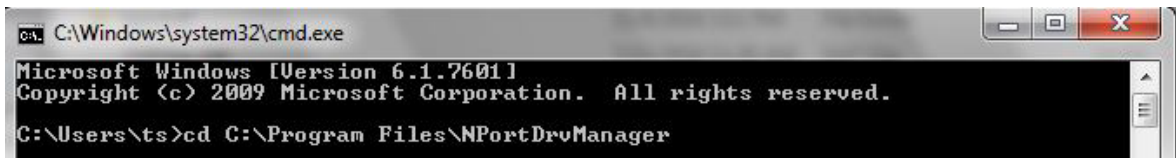

```
C:\Windows\system32\cmd.exe
Microsoft Windows [Version 6.1.7601]
Copyright (c) 2009 Microsoft Corporation. All rights reserved.
C:\Users\ts>cd C:\Program Files\NPortDrvManager
```

Type `npcli /?` to get detailed information of what command lines are supported and the function descriptions.

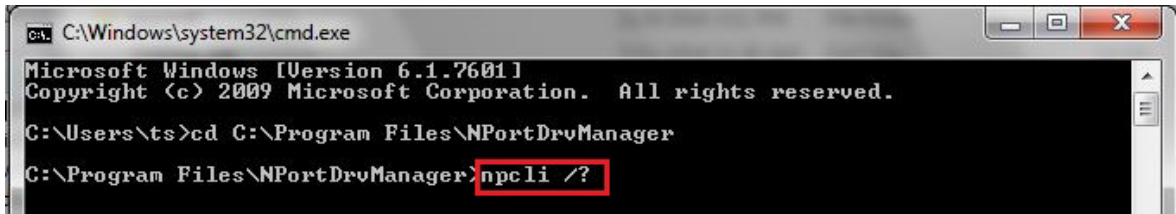

```
C:\Windows\system32\cmd.exe
Microsoft Windows [Version 6.1.7601]
Copyright (c) 2009 Microsoft Corporation. All rights reserved.
C:\Users\ts>cd C:\Program Files\NPortDrvManager
C:\Program Files\NPortDrvManager>npcli /?
```

The usage instructions will show up for a user's reference.

```
-----
NPort Command Line Interface Ver2.0 Build 16052400
-----
usage:

1. NPort Driver operation:
   npcli /driver [/install | /uninstall | /upgrade] [PATH_NAME]

   /install      Install specified driver to host.
   /uninstall    Uninstall current installed driver from host.
   /upgrade      Upgrade specified driver without modifying the mapped ports.
   PATH_NAME     Specify the installer file of the NPort Driver Manager to install
                 or upgrade.

2. RealCOM port operation:
   npcli /driver /add IP_ADDR /port PORT_NO /com COM_NO [/txmode [hiperf |
   classical]] [/fifo [enable | disable]] [/flush [fast | normal]]
   npcli /driver /remove /com [COM_NO | all]

   /add          Add a RealCOM with a valid IP address (IP_ADDR).
   /port         Specify the NPort port number (PORT_NO) to add.
   /com          Specify the COM number to add or remove (COM_NO).
   /txmode       Set the TX mode as hi-performance (hiperf) or classical. The
                 default is hiperf.
   /fifo         Set the FIFO as enable or disable. The default is enable.
   /flush        Set to enable fast flush(fast) or disable fast flush(normal).
                 The default is fast.
   /remove       Remove specified COM number (COM_NO) or all RealCOM ports.

3. NPort devices operation:
   npcli /devicd /search
   npcli /device /set ID /network [/ip IP_ADDR] [/mask SUBNET]
   [/gateway IP_ADDR] [/password CIPHER]
   npcli /device /apply ID [/password CIPHER]

   /search       Search the NPort and store the list to the memory.
   /set          Specify the ID to set. Users must specify one of the searched
```

```
NPorts for further operations. The default is 1.
/port          Specify the NPort port number (PORT_NO) to set.
/password      Specify the password (CIPHER) if the NPort has one.
/network       Set to change the network settings.
/ip            Change the IP address (IP_ADDR) of NPort.
/mask          Change the subnet mask (SUBNET) of NPort.
/gateway       Change the IP address (IP_ADDR) of gateway.
/apply         Specify the ID to save changes and restart the NPort.
```

4. Examples

```
npcli /driver /install D:\Users\drvmgr_setup_Ver1.19.0_Build_15122492
npcli /driver /uninstall
npcli /driver /add 192.168.127.254 /port 1 /com 3
npcli /driver /add 192.168.127.254 /port 2 /com 4 /flush normal
npcli /device /search
npcli /device /set 1 /network /ip 192.168.10.7 /mask 255.255.255.0
    /password moxa
npcli /device /apply 1
```

Note:

Npcli.exe requires an administrator privilege to change device settings.
It support only IPv4 and it must be run under Windows XP and later versions.

Linux Real TTY Drivers

Real TTY driver is provided that will map Linux host TTY ports to NPort serial ports. Once the mapping has been set up, Linux users and applications can connect to a serial port as if it were a local TTY port. These drivers have been designed and tested for most Linux distributions, including Linux kernel version 2.4.x, 2.6.x, and 3.x, 4.x. Please check <http://www.moxa.com> for the latest Linux kernel supported.

Basic Steps

Follow these instructions to map a TTY port to an NPort serial port:

1. Install the NPort device server and set the target device port to Real COM mode.
2. Install the Real TTY driver files on the Linux host.
3. Map the host's TTY port to the target device port on the NPort.

Installing Linux Real TTY Driver Files

Before proceeding with the software installation, make sure you have completed the NPort device server has been installed and configured correctly. Note that the default LAN IP address for the NPort is **192.168.126.254**, whereas the default WLAN IP address is **192.168.127.254**.



ATTENTION

The target serial port must operate in Real COM mode in order to map TTY ports.

1. Get the driver file from https://www.moxa.com/support/support_home.aspx?isSearchShow=1.
2. Log in to the console as a super user (root).
3. Execute **cd /** to go to the root directory.
4. Copy the driver file **npreal2xx.tgz** to the / directory.
5. Execute **tar xvfz npreal2xx.tgz** to extract all files into the system.
6. Execute **/tmp/moxa/mxinst**. (For Red Hat AS/ES/WS and Fedora Core1, execute **"# /tmp/moxa/mxinst SP1"**.) The shell script will install the driver files automatically.

7. After installing the driver, you will see several files in the `/usr/lib/npreal2/driver` folder:
 - mxaddsvr** (add server, map TTY port)
 - mxdelsvr** (delete server, undo TTY port mapping)
 - mxloadsvr** (reload server)
 - mxmknod** (create device node/tty port)
 - mxrmnod** (remove device node/tty port)
 - mxuninst** (remove TTYport and

Enter the new IP address and netmask. If multiple units were selected, you mayMapping TTY Ports

Make sure that you set the operation mode of the desired NPort serial port to Real COM mode. After logging in as a super user, enter the directory `/usr/lib/npreal2/driver` and then execute **mxaddsvr** to map the target NPort serial port to the host TTY ports. The syntax of **mxaddsvr** is as follows:

```
mxaddsvr [NPort IP Address] [Total Ports] ([Data port] [Cmd port])
```

The **mxaddsvr** command performs the following actions:

1. Change `npreal2d.cf`.
2. Create TTY ports in directory `/dev` with major and minor number configured in `npreal2d.cf`.
3. Restart the driver.

Mapping TTY ports automatically

To map TTY ports automatically, you may execute **mxaddsvr** with just the IP address and number of ports, as in the following example:

```
# cd /usr/lib/npreal2/driver
# ./mxaddsvr 192.168.3.4 16
```

In this example, 16 TTY ports will be added, all with IP 192.168.3.4, with data ports from 950 to 965 and command ports from 966 to 981.

Mapping TTY ports manually

To map TTY ports manually, you may execute **mxaddsvr** and manually specify the data and command ports, as in the following example:

```
# cd /usr/lib/npreal2/driver
# ./mxaddsvr 192.168.3.4 16 4001 966
```

In this example, 16 TTY ports will be added, all with IP 192.168.3.4, with data ports from 4001 to 4016 and command ports from 966 to 981.

Removing Mapped TTY Ports

After logging in as root, enter the directory `/usr/lib/npreal2/driver` and then execute **mxdelsvr** to delete a server. The syntax of **mxdelsvr** is:

```
mxdelsvr [IP Address]
```

Example:

```
# cd /usr/lib/npreal2/driver
# ./mxdelsvr 192.168.3.4
```

The following actions are performed when executing **mxdelsvr**:

1. Change `npreal2d.cf`.
2. Remove the relevant TTY ports in directory `/dev`.
3. Restart the driver.

If the IP address is not provided in the command line, the program will list the installed servers and total ports on the screen. You will need to choose a server from the list for deletion.

Removing Linux Driver Files

A utility is included that will remove all driver files, mapped TTY ports, and unload the driver. Enter the directory **/usr/lib/npreal2/driver** and execute **mxuninst** to uninstall the driver. This program will perform the following actions:

1. Unload the driver.
2. Delete all files and directories in **/usr/lib/npreal2**.
3. Delete directory **/usr/lib/npreal2**.
4. Modify the system initializing script file.

UNIX Fixed TTY Drivers

A fixed TTY driver is provided that will map UNIX host TTY ports to NPort serial ports. Once the mapping has been set up, UNIX users and applications can connect to an NPort serial port as if it were a local TTY port. This driver has been designed and tested for most UNIX systems. Please check <http://www.moxa.com> for the latest UNIX systems support.

Installing the UNIX Driver

1. Log in to UNIX and create a directory for the MOXA TTY. To create a directory named **/usr/etc**, execute the command:
mkdir -p /usr/etc
2. Copy **moxattyd.tar** to the directory you created. For the **/usr/etc** directory, you would execute the following commands:
cp moxattyd.tar /usr/etc
cd /usr/etc
3. Extract the source files from the tar file by executing the command:
tar xvf moxattyd.tar
The following files will be extracted:
README.TXT
moxattyd.c --- source code
moxattyd.cf --- an empty configuration file
Makefile --- makefile
VERSION.TXT --- fixed TTY driver version
FAQ.TXT
4. Compile and link.
For SCO UNIX:
make sco
For UnixWare 7:
make svr5
For UnixWare 2.1.x, SVR4.2:
make svr42

Configuring the UNIX Driver

Modify the configuration:

The configuration used by **moxattyd** is defined in the text file **moxattyd.cf**, which is in the same directory. You may use vi or any text editor to change the file, as follows:

ttyp1 192.168.1.1 950

You can refer to **moxattyd.cf** for detailed descriptions of the various configuration parameters. Please note that **Device Name** depends on the OS. See the Device Naming Rule section in README.TXT for more information.

To start the **moxattyd** daemon after system bootup, add an entry into **/etc/inittab** using the TTY name you defined in **moxattyd.cf**, as in the following example:

ts:2:respawn:/usr/etc/moxattyd/moxattyd -t 1

Device naming rule

For UnixWare 7, UnixWare 2.1.x, and SVR4.2, use:

pts/[n]

For all other UNIX operating systems, use:

ttyp[n]

The value of [n] should be equal or larger than 11 in order to prevent conflicts with the device names of functional keys in some UNIX systems.

Starting moxattyd

Execute the command **init q** or reboot your UNIX operating system.

Adding an additional server

Change the text file **moxattyd.cf** to add an additional server. Users may use vi or any text editor to change the file. For more configuration information, refer to **moxattyd.cf**, which contains detailed descriptions of the various configuration parameters.

Find the process ID (PID) of the **moxattyd**.

ps -ef | grep moxattyd

Update the configuration of **moxattyd**.

kill -USR1 [PID]

(e.g., if **moxattyd** PID = 404, **kill -USR1 404**)

This completes the process of adding an additional server.

6. Web Console: Basic Settings

Overview

This chapter introduces the NPort web console and explains how to configure the basic settings.

The NPort can be configured from anywhere on the network through its web console. Simply point the browser to the device server's IP address to open the web console. Network settings, operation mode, and other items can all be configured through the browser.

Navigating the Web Console

To open the web console, enter your device server's IP address in the website address line. If you are configuring the NPort for the first time over an Ethernet cable, you will use the default IP address, **192.168.126.254**.

There are two account types: **admin** and **user**. If you enter the system with **admin** account, you will have the right to read and write. If you enter the system with **user** account, you will only have the right to read.

If prompted, enter the console password. The default password for both **admin** and **user** accounts is **moxa**. The password will be transmitted with MD5 encryption over the Ethernet.

The screenshot shows the MOXA web console interface. At the top, the MOXA logo is on the left, followed by the text "Total Solution for Industrial Device Networking" and the website "www.moxa.com". Below this is a green header bar containing device information:

■ Model	- NPort W2250A-W4-US	■ IP	- 192.168.126.254	■ MAC Address	- 00:90:E8:11:45:A3
■ Name	- NPortW2250A-W4_77	■ Serial No.	- TBBKB0000077	■ Firmware	- 0.1 Build 22071215
■ Location	-				

Below the header bar is a large white area with a vertical grey bar on the left. In the center of this area, there are two input fields labeled "Account" and "Password", and a green "Login" button below them.



ATTENTION

If you have forgotten the password, you can use the reset button to load factory defaults, but this will erase all previous configuration information.

The web console will appear as shown below.

MOXA Total Solution for Industrial Device Networking www.moxa.com

■ Model - NPort W2250A-W4-US ■ IP - 192.168.126.254 ■ MAC Address - 00:90:E8:11:45:A3
 ■ Name - NPortW2250A-W4_77 ■ Serial No. - TBBKB0000077 ■ Firmware - 0.1 Build 22071215
 ■ Location -

Welcome to the NPort W2250A-W4

Model name	NPort W2250A-W4-US
Serial No.	TBBKB0000077
Firmware version	0.1 Build 22071215
Ethernet IP address	192.168.126.254
Ethernet MAC address	00:90:E8:11:45:A3
WLAN IP address	N/A
WLAN MAC address	14:13:33:4B:6A:9D
SSID	N/A
WLAN network type	N/A
WLAN security mode	N/A
WLAN RF type	N/A
WLAN country code	US
WLAN fast roaming	N/A
Active network port	Ethernet
Uptime	0 days 00h:21m:43s
Serial Port 1	Real COM, 115200, None, 8, 2, None
Serial Port 2	Real COM, 115200, None, 7, 2, None

goahead WEB SERVER

Main Menu

- Overview
- Wizard
- Basic Settings
- Network Settings
- Serial Port Settings
- System Management
- System Monitoring
- Restart

Settings are presented on pages that are organized by folder. Select the desired folder in the left navigation panel to open that page. The page will be displayed in the main window on the right. Certain folders can be expanded by clicking the adjacent “-” symbol.

For example, if you click **Basic Settings** in the navigation panel, the main window will show a page of basic settings that you can configure.

After you have made changes on a page, you must click **[Submit]** in the main window before jumping to another page. Your changes will be lost if you do not click **[Submit]**.

Once you click **[Submit]** button, the device server will reboot and with a beep alarm.

Basic Settings

MOXA Total Solution for Industrial Device Networking www.moxa.com

■ Model - NPort W2250A-W4-US ■ IP - 192.168.126.254 ■ MAC Address - 00:90:E8:11:45:A3
 ■ Name - NPortW2250A-W4_77 ■ Serial No. - TBBKB0000077 ■ Firmware - 0.1 Build 22071215
 ■ Location -

Basic Settings

Server Settings

Server name:

Server location:

Time Settings

Time zone:

Local time (24-hour): / / : :

Time server:

Submit

goahead WEB SERVER

Main Menu

- Overview
- Wizard
- Basic Settings
- Network Settings
- Serial Port Settings
- System Management
- System Monitoring
- Restart

On the **Basic Settings** page, you can configure **Server name**, **Server location**, **Time zone (24-hour)**, **Local time**, and **Time server**.

Server Name

Default	NPortW2150A_<serial no.> or NPortW2250A_<serial no.>
Options	free text (e.g., "Server 1")
Description	This is an optional free text field to help you differentiate one device server from another. It does not affect operation of the NPort device server.

Server Location

Default	
Options	free text (e.g., "Bldg 1, 2nd Floor")
Description	This is an optional free text field to help you differentiate one device server from another. It does not affect operation of the NPort device server.

Time Zone

Default	(GMT)Greenwich Mean Time
Options	(GMT)Greenwich Mean Time (GMT-01:00)Azores, Cape Verde Is. (GMT-02:00)Mid-Atlantic etc.
Description	This field shows the currently selected time zone and allows you to select a different time zone.

Local Time

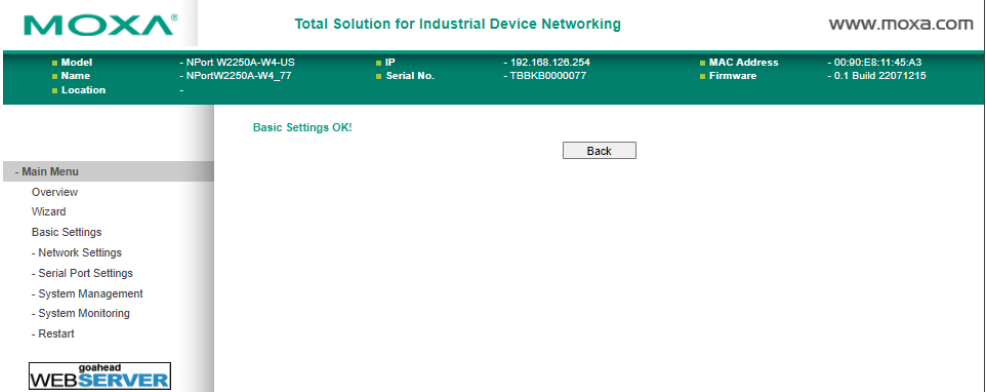
Default	
Options	Date (yy:mm:dd), Time (hh:mm:ss)
Description	<p>The NPort has a built-in real-time clock that allows you to add time information to functions such as the automatic warning e-mail or SNMP trap. This field shows the current time according to the NPort's built-in real-time clock. This is not a live field, so you will need to refresh the browser to get an updated reading.</p> <p>Change the correct date or time, and click [Submit]. The change will take effect directly, and shows Basic Setting OK!.</p>
	



ATTENTION

There is a risk of an explosion if the real-time clock battery is replaced incorrectly!

The real-time clock is powered by a lithium battery. We strongly recommend that you get help from a Moxa support engineer before replacing the battery. Please contact the Moxa RMA service team if you need to change the battery.

Time Server

Default	
Options	IP address or domain name (e.g., "192.168.1.1" or "time.nist.gov")
Description	This optional field specifies your time server's IP address or domain name, if a time server is used in your network. The NPort supports SNTP (RFC-1769) for automatic time calibration. The device server will request time information from the specified time server every 10 minutes.

7. Web Console: Network Settings

Overview

This chapter explains how to configure all settings located under the **Network Settings** folder in the NPort web console.

Network Settings

General Settings

The screenshot shows the Moxa web console interface. At the top, there is a header with the Moxa logo, the tagline "Total Solution for Industrial Device Networking", and the website "www.moxa.com". Below the header is a status bar displaying system information: Model (NPort W2250A-W4-US), Name (NPortW2250A-W4_77), Location, IP (192.168.128.254), Serial No. (TBBKB0000077), MAC Address (00:90:E8:11:45:A3), and Firmware (0.1 Build 22071215). The main content area is titled "General Settings" and contains two input fields for "DNS Server 1" and "DNS Server 2", and a "Submit" button. A left-hand navigation menu is visible, with "General Settings" under the "Network Settings" folder highlighted with a red circle.

On the General Settings page in the Network Settings folder, you can change DNS server 1 and 2.

DNS Server 1 and 2

Default	
Options	IP address (e.g., "192.168.1.1")
Description	<p>This field is for the DNS server's IP address, if applicable. With the DNS server configured, the NPort device server can use domain names instead of IP addresses to access hosts.</p> <p>Domain Name System (DNS) is how Internet domain names are identified and translated into IP addresses. A domain name is an alphanumeric name, such as www.moxa.com, that it is usually easier to remember than the numeric IP address. A DNS server is a host that translates a text-based domain name into an IP address in order to establish a TCP/IP connection. When the user wants to visit a particular website, the user's computer sends the domain name (e.g., www.moxa.com) to a DNS server to request that website's numeric IP address. When the IP address is received from the DNS server, the user's computer uses that information to connect to the website's web server.</p> <p>The NPort will play the role of a DNS client, actively querying the DNS server for the IP address associated with a particular domain name.</p>

Ethernet/Bridge Settings

To enable the Ethernet-to-Wireless function, also called Wireless Client, go to the **Ethernet/Bridge Settings** page and enable **Ethernet Bridge**. When it's enabled, the LAN and WLAN will use the same IP configuration (use the same IP address, netmask and gateway settings).

MOXA Total Solution for Industrial Device Networking www.moxa.com

Model: NPort W2250A-W4-US | IP: 192.168.126.254 | MAC Address: 00:90:E8:11:45:A3
 Name: NPortW2250A-W4_77 | Serial No.: TBBKB000077 | Firmware: 0.1 Build 22071215
 Location: -

Network Settings - Ethernet/Bridge

Network Settings - Ethernet/Bridge

Ethernet bridge: Enable

IP configuration: Static

IP address: 192.168.126.254

Netmask: 255.255.255.0

Gateway: [Empty]

- Main Menu
- Overview
- Wizard
- Basic Settings
 - Network Settings
 - General Settings**
 - Ethernet/Bridge Settings**
 - WLAN Settings
 - Advanced Settings
- Serial Port Settings
- System Management
- System Monitoring
- Restart



ATTENTION

In dynamic IP environments, the NPort will send three requests every 30 seconds to the DHCP server until the network settings have successfully been assigned. The first request will time out after one second; the second request will time out after three seconds, and the third request will timeout after five second. If the DHCP server is unavailable, the NPort will use the factory default network settings.

Ethernet Bridge

Default	Disabled
Options	Enabled, Disabled
Description	<p>This field specifies whether to enable Ethernet Bridge mode or not. When Ethernet Bridge is enabled, the LAN and WLAN interfaces are bridged together. Data can be seamlessly transferred between serial lines, LAN, and WLAN. The LAN and WLAN will use the LAN IP setting, and WLAN IP setting will be disabled.</p> <p>Disabled: When disabled, you can use either the LAN or WLAN. Enabled: When enabled, you can use both the LAN and the WLAN.</p> <p>Legend: — Ethernet — Serial</p>

IP Configuration

Default	Static
Options	Static, DHCP
Description	This field determines how the NPort's IP address will be assigned. Static: IP address, netmask, and gateway are user-defined. DHCP: IP address, netmask, gateway, DNS, and time server are assigned by the DHCP server.

IP Address

Default	192.168.126.254
Options	IP address (e.g., "192.168.1.1")
Description	This field is for the IP address that will be assigned to your NPort device server. An IP address is a number assigned to a network device (such as a computer) as a permanent address on the network. Computers use the IP address to identify and talk to each other over the network. Choose a proper IP address that is unique and valid in your network environment. If your device server will be assigned a dynamic IP address, set the IP configuration parameter appropriately.

Netmask

Default	255.255.255.0
Options	Netmask setting (e.g., "255.255.0.0")
Description	This field is for the subnet mask. A subnet mask represents all of the network hosts at one geographic location, in one building, or on the same local area network (LAN). When a packet is sent out over the network, the NPort device server will use the subnet mask to check whether the desired TCP/IP host specified in the packet is on the local network segment. If the address is on the same network segment as the device server, a connection is established directly from the device server. Otherwise, the connection is established through the gateway as specified in the Gateway parameter.

Gateway

Default	
Options	IP address (e.g., "192.168.1.1")
Description	This field is for the IP address of the gateway, if applicable. A gateway is a network computer that acts as an entrance to another network. Usually, the computers that control traffic within the network or at the local Internet service provider are gateway nodes. The NPort device server needs to know the IP address of the default gateway computer in order to communicate with the hosts outside the local network environment. Consult your network administrator if you do not know how to set this parameter.

WLAN Settings

WLAN

The screenshot shows the Moxa web interface. At the top, there is a header with the Moxa logo, the tagline 'Total Solution for Industrial Device Networking', and the website 'www.moxa.com'. Below the header is a status bar with system information: Model (NPort W2250A-W4-US), Name (NPortW2250A-W4_77), Location, IP (192.168.128.254), Serial No. (TBBKB0000077), MAC Address (00:90:E8:11:45:A3), and Firmware (0.1 Build 22071215). The main content area is titled 'WLAN Settings'. On the left, a navigation menu is visible, with 'WLAN' circled in red. The 'WLAN Settings' form includes a dropdown for 'IP configuration' set to 'Static', and input fields for 'IP address' (192.168.127.254), 'Netmask' (255.255.255.0), and 'Gateway'. A 'Submit' button is located at the bottom of the form.

The **WLAN** page is located under **WLAN Settings** in the **Network Settings** folder. You can modify **IP configuration**, **IP address**, **Netmask**, and **Gateway** for your WLAN.

The NPort W2150A-W4/W2250A-W4 Series supports IEEE 802.11a/b/g/n wireless network interfaces. The supported IP configurations are static and dynamic (DHCP). Users can set up the IP configuration with the serial console, or the Web/Telnet consoles through the NPort's Ethernet interface. For detailed information about configuring **IP configuration**, **IP address**, **Netmask**, and **Gateway**, see the previous section, Ethernet Configuration.

IP Configuration

Default	Static
Options	Static, DHCP
Description	This field determines how the NPort's IP address will be assigned. Static: IP address, netmask, and gateway are user-defined. DHCP: IP address, netmask, gateway, DNS, and time server are assigned by the DHCP server.

IP Address

Default	192.168.127.254
Options	IP address (e.g., "192.168.1.1")
Description	This field is for the IP address that will be assigned to your NPort device server. An IP address is a number assigned to a network device (such as a computer) as a permanent address on the network. Computers use the IP address to identify and talk to each other over the network. Choose a proper IP address that is unique and valid in your WLAN environment. If your device server will be assigned a dynamic IP address, set the IP configuration parameter appropriately.

Netmask

Default	255.255.255.0
Options	Netmask setting (e.g., "255.255.0.0")
Description	This field is for the subnet mask. A subnet mask represents all the network hosts at one geographic location, in one building, or on the same LAN. When a packet is sent out over the network, the NPort device server will use the subnet mask to check whether the desired TCP/IP host specified in the packet is on the local network segment. If the address is on the same network segment as the device server, a connection is established directly from the device server. Otherwise, the connection is established through the gateway as specified in the Gateway parameter.

Gateway

Default	
Options	IP address (e.g., "192.168.1.1")
Description	This field is for the IP address of the gateway, if applicable. A gateway is a network computer that acts as an entrance to another network. Usually, the computers that control traffic within the network or at the local Internet service provider are gateway nodes. The NPort device server needs to know the IP address of the default gateway computer in order to communicate with the hosts outside the local network environment. Consult your network administrator if you do not know how to set this parameter.

Profile

Total Solution for Industrial Device Networking
www.moxa.com

■ Model	- NPort W2250A-W4-US	■ IP	- 192.168.128.254	■ MAC Address	- 00:90:E8:11:45:A3
■ Name	- NPortW2250A-W4_77	■ Serial No.	- TBBKB0000077	■ Firmware	- 0.1 Build 22071215
■ Location	-				

Wireless LAN Profile Settings

- Main Menu

- Overview
- Wizard
- Basic Settings
- Network Settings
 - General Settings
 - Ethernet/Bridge Settings
 - WLAN Settings
 - WLAN
 - Profile**
 - WLAN Log Settings
 - Advanced Settings
- Serial Port Settings
- System Management
- System Monitoring
- Restart

Wireless LAN Profile

Network type:

Profile name:

Please remember to activate Profile service by pressing "Activate" button after configuring.

Total Solution for Industrial Device Networking
www.moxa.com

■ Model	- NPort W2250A-W4-US	■ IP	- 192.168.128.254	■ MAC Address	- 00:90:E8:11:45:A3
■ Name	- NPortW2250A-W4_77	■ Serial No.	- TBBKB0000077	■ Firmware	- 0.1 Build 22071215
■ Location	-				

WLAN Profile Properties

- Main Menu

- Overview
- Wizard
- Basic Settings
- Network Settings
 - General Settings
 - Ethernet/Bridge Settings
 - WLAN Settings
 - WLAN
 - Profile
 - WLAN Log Settings
 - Advanced Settings
 - Serial Port Settings
 - System Management

General Properties

Profile name:

RF type:

SSID:

Fast roaming:

Scan channels - 1:

Scan channels - 2:

Scan channels - 3:

Roaming threshold: dBm (-70~-40)

Roaming difference: dBm (2~10)

The Profile page is located under **WLAN Settings** in the **Network Settings** folder. This is where you configure the NPort for Infrastructure operation. Different settings are available depending on whether you select AP Mode or Infrastructure Mode.



NOTE

AP Mode is supported starting from firmware version V1.4 and later, and it can replace Ad-hoc mode application architecture of NPort W2x50A, achieving point-to-point connections.

Network Type

Default	Infrastructure Mode
Options	Infrastructure Mode, AP Mode (For Firmware V1.4 and later versions)
Description	This field specifies whether the NPort will operate in AP or Infrastructure Mode. For all wireless networking devices, there are two possible modes for communication with another wireless device. Device that is configured for AP Mode acts as an AP and waiting for another device that is configured for Infrastructure Mode connecting to it. Wireless devices that are configured for Infrastructure Mode do not communicate directly with each other, but through a wireless access point (AP).

Example of Infrastructure Mode

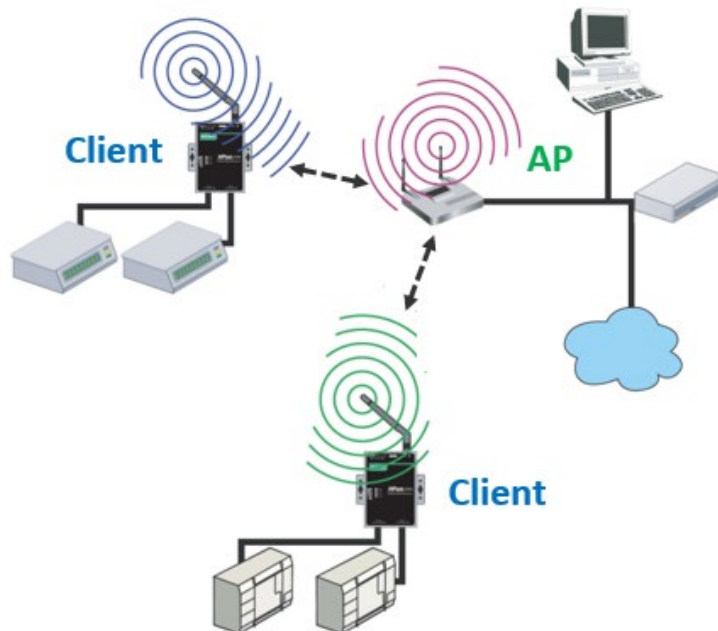

Example of AP Mode

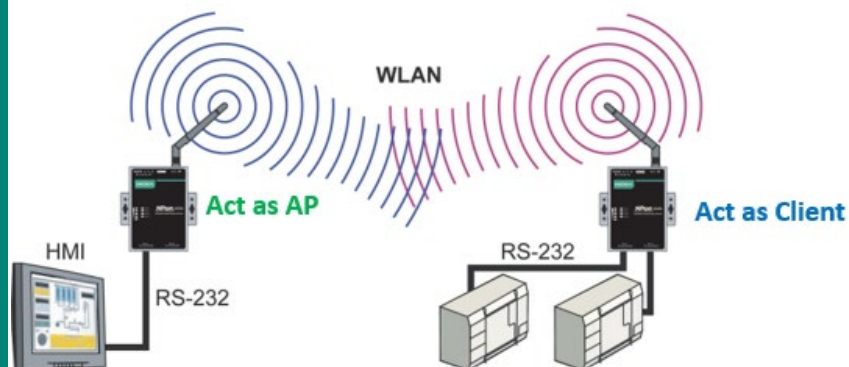

After setting the Network type, you will need to adjust the General and Security settings to establish the wireless connection.

General Settings for WLAN Profile

The **General** page is opened through the **Profile** page, under **WLAN Settings** in the **Network Settings** folder. You can type a profile name to help you differentiate one profile from another. It does not affect the operation of the NPort. Click **[General]** to open the General page for the selected profile. In Infrastructure Mode, only one profile is available.

In Infrastructure Mode

MOXA Total Solution for Industrial Device Networking www.moxa.com

Model	- NPort W2250A-W4-US	IP	- 192.168.126.254	MAC Address	- 00:90:E8:11:45:A3
Name	- NPortW2250A-W4_77	Serial No.	- TBBKB0000077	Firmware	- 0.1 Build 22071215
Location	-				

Wireless LAN Profile Settings

Wireless LAN Profile

Network type: Infrastructure Mode

Profile name: Infrastructure

General Security

Submit Activate

Please remember to activate Profile service by pressing "Activate" button after configuring.

MOXA Total Solution for Industrial Device Networking www.moxa.com

Model	- NPort W2250A-W4-US	IP	- 192.168.126.254	MAC Address	- 00:90:E8:11:45:A3
Name	- NPortW2250A-W4_77	Serial No.	- TBBKB0000077	Firmware	- 0.1 Build 22071215
Location	-				

WLAN Profile Properties

General Properties

Profile name: Infrastructure

RF type: Auto

SSID: profile1 Site Survey

Fast roaming: Disable

Scan channels - 1: N/A

Scan channels - 2: N/A

Scan channels - 3: N/A

Roaming threshold: -70 dBm (-70~-40)

Roaming difference: 2 dBm (2~10)

Submit

In AP Mode (For Firmware V1.4 and later versions)

The top screenshot shows the 'Wireless LAN Profile Settings' page. The 'Network type' is set to 'AP Mode' and the 'Profile name' is 'AP'. The 'Submit' button is circled in red, and a red arrow points to the 'WLAN Profile Properties' page in the bottom screenshot. The bottom screenshot shows the 'General Properties' page with 'Profile name' set to 'AP', 'RF type' set to '802.11b/g', 'SSID' set to 'MOXA', and 'Channel' set to '1'.

On the General page, you can configure **Profile name**, **RF type**, and input an **SSID** provided by your Wi-Fi AP. Additional settings are also available depending on whether you select AP Mode or Infrastructure Mode.

Profile Name

Default	Infrastructure (in Infrastructure Mode), AP (in AP Mode)
Options	Free text (e.g., "Primary Connection")
Description	This is a free text field to help you differentiate one profile from another. It does not affect the operation of the NPort.

RF Type

Default	Auto for Infrastructure Mode. 802.11b/g for AP Mode.
Options	Auto (Infrastructure Mode only), 802.11a, 802.11b/g, 802.11a/n, 802.11b/g/n
Description	This field determines which wireless standard will be used by the selected profile. 802.11a, 802.11b/g, 802.11a/n and 802.11b/g/n are supported. Auto: In Infrastructure Mode, the NPort will automatically select between 802.11a, 802.11b/g, 802.11a/n and 802.11b/g/n according to the settings of the AP. 802.11a: The Unlicensed National Information Infrastructure (UNII) 5 GHz band is used for communication, which is different from the RF band used by 802.11b and 802.11g. Consequently, 802.11a devices cannot communicate with 802.11b or 802.11g devices. (Multi-mode 802.11a/b/g APs or client adapters can be used to resolve this.) Transmission rates up to 54Mbps are supported. 802.11b/g: This option means our device will support 802.11b or 802.11g. 802.11b: This is the well-known "Wi-Fi" standard, also referred to as "802.11 High-Rate (HR)." Wireless communication is in the 2.4 GHz ISM band, using the DSSS spread spectrum transmission scheme. 802.11b supports data rates of 1 Mbps, 2 Mbps, 5.5 Mbps, and 11 Mbps.

802.11a/n: This option means our device will support up to 150 Mbps data rate to communicate with an 802.11a/n AP. 802.11b/g/n: This option means our device will support up to 72.2 Mbps data rate to communicate to an 802.11b/g/n AP.

SSID

Default	Profile1 (in Infrastructure Mode), MOXA (in AP Mode)
Options	Free text (e.g., "Coffeeshop WLAN")
Description	This field specifies the SSID, or name, of the wireless network (SSID) that will be used by the NPort. Wireless devices must use the same SSID in order to communicate with each other.

Site Survey

When you click **Site Survey**, the device server will scan for all the APs it can find nearby. It shows all the signal strengths between the device server and the APs. You may check the checkbox and click **OK** to create a profile for the specified AP.

192.168.126.254/wlan_site_survey.asp

SSID	Security	Signal Strength
<input type="checkbox"/> ABCDEF	WPA2-PSK	-86 dBm
<input type="checkbox"/> HTC 3110	WPA2-PSK	-81 dBm
<input type="checkbox"/> LEI	None	-88 dBm
<input type="checkbox"/> LKHQWHL	None	-90 dBm
<input type="checkbox"/> MHC-Moxia	WPA2	-71 dBm
<input type="checkbox"/> MHC-Moxia	WPA2-PSK	-71 dBm
<input type="checkbox"/> MHC-HB	WPA2	-88 dBm
<input type="checkbox"/> PXC_1	WPA2-PSK	-74 dBm
<input type="checkbox"/> Sceptic_BK270m_d75da3	WPA	-71 dBm
<input type="checkbox"/> UFGHD	WPA2	-74 dBm
<input type="checkbox"/> Unitech	WPA2-PSK	-69 dBm
<input type="checkbox"/> UFGMobile	WPA2-PSK	-71 dBm

OK Cancel Refresh

Channel (AP mode only)

Default	1				
Options		US	CN	EU	JP
	2.4G	1-11	1-13	1-13	1-13
	11b/g				
	11b/g/n				
	5G	36	36	36	36
	11a	40	40	40	40
	11a/n	44	44	44	44
		48	48	48	48
		149	149		
		153	153		
		157	157		
		161	161		
		165	165		
Description	This field is for AP Mode only and specifies the radio channel to be used for the wireless network.				

Fast Roaming (Infrastructure mode only)

Default	Disable
Options	Disable, Enable
Description	<p>This field is available in Infrastructure Mode and is used to specify the NPort W2150A-W4/W2250A-W4 Series roaming behavior. Roaming is the ability to connect to different APs so that wireless communication is not confined to one area or one particular AP. The NPort W2150A-W4/W2250A-W4 Series will only roam between APs, as specified by the SSID.</p> <p>Disable: Fast Roaming function will be disabled.</p> <p>NPort W2150A-W4/W2250A-W4 Series will scan all available channels and roam between APs as specified by the SSID. It scans the channel when booting up and will associate with the highest signal strength AP. Only when the associated AP is lost, it will re-associate again.</p> <p>Enable: Fast Roaming function will be enabled.</p> <p>NPort W2150A-W4/W2250A-W4 Series will only scan the pre-defined Scan Channels - 1, Scan Channels - 2 & Scan Channels - 3 and roam between APs as specified by the SSID.</p> <p>It scans the channel and will associate with the highest signal strength AP. It also scans the channel regularly and will re-associate with the highest signal strength AP (if there is) automatically.</p>

Scan Channels – 1, Scan Channels – 2, Scan Channels – 3 (Infrastructure Mode)

Default	N/A
Options	1 through 13, 36, 40, 44, 48, 52, 56, 60, 64, 100, 104, 108, 112, 116, 120, 124, 128, 132, 136, 140
Description	This field is for fast roaming under Infrastructure Mode and specifies the radio channel to use for the wireless network. Choose the channel according to the factory setting of the AP.

Roaming Threshold

Default	-70 (Disable)
Options	numbers
Description	When the signal strength between the device and the AP is worse than this number, below -70 dBm as the default number, the device server will scan for a new AP to establish the connection.

Roaming Difference

Default	2 (Disable)
Options	numbers
Description	When the device server finds a new AP, the signal strength between the device server and the new AP must be above this number compared to the old AP, then the device server will change to establish a new connection with the new AP. For example, when the signal strength to the old AP is -70 dBm. When the new AP is -69 dBm, the device server will keep the connection to the old one. If the new AP is -68 dBm, the device server will switch the connection to the new AP.

Security Settings for WLAN Profile

The **Security** page is opened through the **Profile** page, under **WLAN Settings** in the **Network Settings** folder. In Infrastructure Mode, click [**Security**] to open the Security page. Three profiles are available in Infrastructure Mode.

In Infrastructure Mode

MOXA® Total Solution for Industrial Device Networking www.moxa.com

Model	- NPort W2250A-W4-US	IP	- 192.168.126.254	MAC Address	- 00:90:E8:11:45:A3
Name	- NPortW2250A-W4_77	Serial No.	- TBBKB0000077	Firmware	- 0.1 Build 22071215
Location	-				

Wireless LAN Profile Settings

Wireless LAN Profile

Network type: Infrastructure Mode

Profile name: Infrastructure

General Security

Submit Activate

Please remember to activate Profile service by pressing "Activate" button after configuring.

MOXA® Total Solution for Industrial Device Networking www.moxa.com

Model	- NPort W2250A-W4-US	IP	- 192.168.126.254	MAC Address	- 00:90:E8:11:45:A3
Name	- NPortW2250A-W4_77	Serial No.	- TBBKB0000077	Firmware	- 0.1 Build 22071215
Location	-				

WLAN Profile Properties

Security Properties

Profile name: Infrastructure

Authentication: Open System

Encryption: Disable

Submit

In AP Mode

MOXA® Total Solution for Industrial Device Networking www.moxa.com

Model	- NPort W2150A-W4-EU	IP	- 192.168.126.254	MAC Address	- 00:90:E8:AE:38:04
Name	- NPortW2150A-W4_98995	Serial No.	- TBBHB1198995	Firmware	- 1.4.0 Build 24022610
Location	-				

Wireless LAN Profile Settings

Wireless LAN Profile

Network type: AP Mode

Profile name: AP

General Security

Submit Activate

Please remember to activate Profile service by pressing "Activate" button after configuring.

MOXA® Total Solution for Industrial Device Networking www.moxa.com

Model	- NPort W2150A-W4-EU	IP	- 192.168.126.254	MAC Address	- 00:90:E8:AE:38:04
Name	- NPortW2150A-W4_98995	Serial No.	- TBBHB1198995	Firmware	- 1.4.0 Build 24022610
Location	-				

WLAN Profile Properties

Security Properties

Profile name: AP

Authentication: Open System

Encryption: Disable

Submit

You will need to configure **Authentication** and **Encryption**. These settings must match the settings on the wireless device at the other end of the connection (such as the AP). Different settings and options are available depending on how **Authentication** and **Encryption** are configured.

Authentication

Default	Open System
Options	Open System, Shared Key, WPA, WPA-PSK, WPA2, WPA2-PSK
Description	<p>This field specifies how wireless devices will be authenticated. Only authenticated devices will be allowed to communicate with the NPort. If a RADIUS server is used, this setting must match the setting on the RADIUS server.</p> <p>Open System: The NPort will simply announce a desire to associate with access point. No authentication is required.</p> <p>Shared Key: Authentication involves a more rigorous exchange of frames to ensure that the requesting station is authentic. WEP encryption is required.</p> <p>WPA: This is a managed authentication option in Infrastructure Mode. The Wi-Fi Alliance, the industry trade group that owns the Wi-Fi trademark and certifies devices with the Wi-Fi name created WPA. It is based on Draft 3 of the IEEE 802.11i standard. Each user uses a unique key for authentication, distributed from an IEEE 802.1X authentication server, also known as a RADIUS server. We also referred this option to as WPA Enterprise Mode, since it should meet rigorous enterprise security requirements. Tunneled authentication is supported, depending on the EAP method selected.</p> <p>WPA-PSK: This is an unmanaged authentication option in Infrastructure Mode. Instead of a unique key for each user, a pre-shared key (PSK) is manually entered on the access point to generate an encryption key that is shared among all users. Consequently, this method does not scale well for enterprise. A PSK that uses a mix of letters, numbers and non-alphanumeric characters is recommended. This option is also referred to as WPA Personal Mode, since it is designed for the needs and capabilities of small home and office WLANs.</p> <p>WPA2: This is a managed authentication option in Infrastructure Mode. WPA2 implements the mandatory elements of 802.11i. Supported encryption algorithms include TKIP, Michael, and AES-based CCMP, which is considered fully secure. Since March 13, 2006, WPA2 has been mandatory for all Wi-Fi-certified devices. We may also refer this option to as WPA2 Enterprise Mode. Tunneled authentication is supported, depending on the EAP method selected.</p> <p>WPA2-PSK: This is an unmanaged authentication option in Infrastructure Mode. It employs WPA2 encryption algorithms but relies on a PSK for authentication. A PSK that uses a mix of letters, numbers and non-alphanumeric characters is recommended. We can also refer this option to as WPA Personal Mode.</p>

Encryption

Default	Disable
Options	Disable, WEP, TKIP, AES-CCMP
Description	<p>This field specifies the type of encryption to use during wireless communication. Different encryption methods are available depending on the Authentication setting. Also, each encryption method has its own set of parameters that may also require configuration.</p> <p>Disable: No encryption applies to the data during wireless communication. This option is only available if Authentication is set to Open System.</p> <p>WEP: Wired Equivalent Privacy (WEP) is only available for Open System and Shared Key authentication methods. Data is encrypted according to a key. The NPort supports both 64 and 128-bit keys. This method may deter casual snooping, but is not considered very secure.</p> <p>TKIP: Temporal Key Integrity Protocol (TKIP) is only available for WPA, WPA2, WPA-PSK, and WPA2-PSK authentication methods. TKIP is part of a draft standard from the IEEE 802.11i working group and uses the RC4 stream cipher with 128-bit keys for encryption and 64-bit keys for authentication. TKIP improves on WEP by adding a per-packet key mixing function to de-correlate the public initialization vectors (IVs) from weak keys.</p> <p>AES-CCMP: This is a powerful encryption method that is only available for WPA, WPA2, WPA-PSK, and WPA2-PSK authentication methods. Advanced Encryption Standard (AES) is the block cipher system used by the Robust Secure Network (RSN) protocol and is equivalent to the RC4 algorithm used by WPA. CCMP is the security protocol used by AES, equivalent to TKIP for WPA. Data undergoes a Message Integrity Check (MIC) using a well-known and proven technique called Cipher Block Chaining Message Authentication Code (CBC-MAC). The technique ensures that even a one-bit alteration in a message produces a dramatically different result. Master keys are not used directly but are used to derive other keys, each of which expire after a certain amount of time. Messages are encrypted using a secret 128-bit key and a 128-bit block of data. The encryption process is complex, but the administrator does not need to be aware of the intricacies of the computations. The result is encryption that is much harder to break than even WPA.</p>

PSK Passphrase

Default	
Options	free text (e.g., "This is the WLAN passphrase")
Description	This field is only available for WPA-PSK and WPA2-PSK authentication methods. If the NPort's passphrase does not match the AP's passphrase, the connection will be denied. A PSK of sufficient strength—one that uses a mix of letters, numbers and non-alphanumeric characters—is recommended.

Security Settings for WEP Encryption

The screenshot shows the Moxa web interface for configuring WLAN Profile Properties. The Security Properties section is highlighted with a red box. The settings are as follows:

- Profile name: Infrastructure
- Authentication: Open System
- Encryption: WEP
- WEP key length: 64-bits
- WEP key index: 1
- WEP key source: Manual Generate WEP keys by passphrase
- WEP key format: ASCII
- WEP key 1: [Empty field]
- WEP key 2: [Empty field]
- WEP key 3: [Empty field]
- WEP key 4: [Empty field]
- Submit button

When Encryption is set to WEP on the **Security** page for the WLAN profile, you will configure **WEP key length**, **WEP key index**, and **WEP key source**. It will display other settings, depending on how **WEP key source** is configured.

WEP Key Length

Default	64bits
Options	64bits, 128bits
Description	This field specifies the length of the WEP key. 64bits is the industry standard for WEP, but 128bits provides better protection.

WEP Key Index

Default	1
Options	1 through 4
Description	This field specifies the primary WEP key to use for the WLAN.

WEP Key Source

Default	Manual
Options	Manual, Generate WEP keys by passphrase
Description	This field specifies whether the WEP key will be generated manually or through a user-specified passphrase. A passphrase is equivalent to a free-text password that will generate the WEP key. A passphrase is typically easier to remember and enter than a long and complicated WEP key.

WEP Passphrase

Default	
Options	free text (e.g., "This is the WEP passphrase")
Description	This field is only available if WEP key source is set to Generate WEP keys by passphrase . A standard hexadecimal password will be generated using the supplied passphrase. For example, if "404tech" is entered, the WEP key will be "DB971608E942FC39BD89FC4ADB".

WEP Key Format

Default	ASCII
Options	ASCII, HEX
Description	This field is only available if WEP key source is set to Manual. It specifies the format you will use to enter the WEP key.

WEP Key 1 Through 4

Default														
Options	free text in ASCII or HEX													
Description	These fields are only available if WEP key source is set to Manual. Enter each WEP key in ASCII or HEX as specified in WEP key format. The number of characters required for each key depends on WEP key length and WEP key format.													
	<table border="1"> <thead> <tr> <th>WEP Key Length</th> <th>WEP Key Format</th> <th>Key Length</th> </tr> </thead> <tbody> <tr> <td rowspan="2">64bits</td> <td>ASCII</td> <td>5 characters</td> </tr> <tr> <td>HEX</td> <td>10 characters</td> </tr> <tr> <td rowspan="2">128bits</td> <td>ASCII</td> <td>13 characters</td> </tr> <tr> <td>HEX</td> <td>26 characters</td> </tr> </tbody> </table>	WEP Key Length	WEP Key Format	Key Length	64bits	ASCII	5 characters	HEX	10 characters	128bits	ASCII	13 characters	HEX	26 characters
WEP Key Length	WEP Key Format	Key Length												
64bits	ASCII	5 characters												
	HEX	10 characters												
128bits	ASCII	13 characters												
	HEX	26 characters												

Security Settings for WPA, WPA2

MOXA Total Solution for Industrial Device Networking www.moxa.com

Model: NPort W2250A-W4-US | IP: 192.168.126.254 | MAC Address: 00:90:E8:11:45:A3
 Name: NPortW2250A-W4_77 | Serial No.: TBBKB0000077 | Firmware: 0.1 Build 22071215
 Location: -

WLAN Profile Properties

Security Properties

Profile name: Infrastructure

Authentication: **WPA** (selected)

Encryption: []

EAP method: []

Username: []

Verify server certificate: []

Trusted server certificate: Not Installed

User certificate: Not Installed

User private key: Not Installed

MOXA Total Solution for Industrial Device Networking www.moxa.com

Model: NPort W2250A-W4-US | IP: 192.168.126.254 | MAC Address: 00:90:E8:11:45:A3
 Name: NPortW2250A-W4_77 | Serial No.: TBBKB0000077 | Firmware: 0.1 Build 22071215
 Location: -

WLAN Profile Properties

Security Properties

Profile name: Infrastructure

Authentication: WPA

Encryption: TKIP

EAP method: TLS

Username: []

Verify server certificate: Disable

Trusted server certificate: Not Installed

User certificate: Not Installed

User private key: Not Installed

When WPA or WPA2 is used for authentication, you will also need to configure **EAP method** in the **Security** settings for the WLAN profile. It will also display other settings, depending on how **EAP method** is configured.

There are two parts to WPA and WPA2 security, authentication, and data encryption.

- Authentication occurs before access is granted to a WLAN. Wireless clients such as the NPort W2150A-W4/W2250A-W4 Series are first authenticated by the AP according to the authentication protocol used by the RADIUS server. Depending on the WLAN security settings, an EAP tunnel can scramble the username and password that is submitted for authentication purposes.

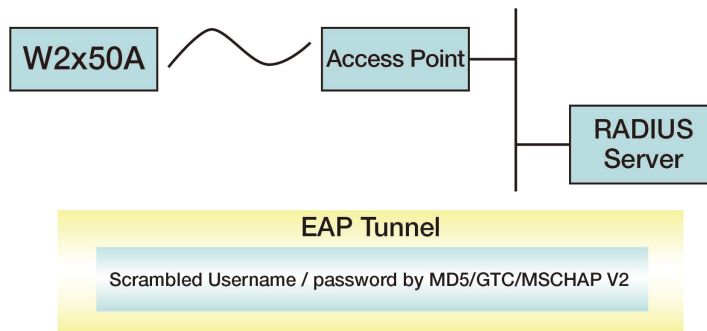

- Encryption occurs after WLAN access has been granted. For all wireless devices, data is first encrypted before wireless transmission, using mutually agreed-upon encryption protocol.

EAP Method

Default	PEAP
Options	TLS, PEAP, TTLS, LEAP
Description	<p>This field specifies the EAP method to use for authentication. Four methods are supported.</p> <p>TLS: Transport Layer Security (TLS) was created by Microsoft and accepted by the IETF as RFC 2716: PPP EAP TLS Authentication Protocol. Passwords and tunneled authentication are not used. A user certificate and user private key are used to identify the NPort. The NPort's user certificate and user private key must already be installed on the RADIUS server.</p> <p>PEAP: Protected Extensible Authentication Protocol (PEAP) is a proprietary protocol which was developed by Microsoft, Cisco, and RSA Security.</p> <p>TTLS: Tunneled Transport Layer Security (TTLS) is a proprietary protocol which was developed by Funk Software and Certicom, and is supported by Agere Systems, Proxim, and Avaya. TTLS is being considered by the IETF as a new standard. For more information on TTLS, read the draft RFC EAP Tunneled TLS Authentication Protocol.</p> <p>LEAP: Lightweight Extensible Authentication Protocol (LEAP) is a proprietary protocol which was developed by Cisco. LEAP doesn't check certificate during the authentication process.</p>

Tunneled Authentication

Default	PAP (when using TTLS) GTC (when using PEAP)
Options	GTC, MD5, MSCHAP V2 (when using PEAP) PAP, CHAP, MSCHAP, MSCHAP V2, EAP-MSCHAP V2, EAP-GTC, EAP-MD5 (when using TTLS)
Description	This field specifies the encryption method to use during the authentication process. Different methods are available, depending on the EAP Method setting.

Username

Default	
Options	free text (e.g., "Smith_John")
Description	This field specifies the username that will gain access to the WLAN. The correct username and password must be provided for access to be granted.

Password

Default	
Options	free text (e.g., "Password123")
Description	This field specifies the password that will gain access to the WLAN. The correct username and password must be provided for access to be granted.

Anonymous Username

Default	
Options	free text (e.g., "Anyuser")
Description	This field specifies the anonymous username to use when starting authentication. After the RADIUS Server has been verified by certificate, the true username and password will complete the authentication process.

Verify Server Certificate

Default	Disable
Options	Disable, Enable
Description	Disable: The certificate from the RADIUS server will be ignored. Enable: The certificate from the RADIUS server will authenticate access to the WLAN. The RADIUS server's trusted server certificate must already be installed on the NPort. To install a trusted server certificate, visit the corresponding page in the System Management > Certificate folder.

Trusted Server Certificate

This field is available for PEAP, TLS, and TTLS EAP methods only. It displays information on the trusted server certificate that is installed on the NPort. To install a trusted server certificate, visit the corresponding page in the **System Management > Certificate** folder.

User Certificate

This field is available only when the EAP method has been set to TLS. It displays information on the user certificate that is installed on the NPort. To install a user certificate, visit the corresponding page in the **System Management > Certificate** folder.

User Private Key

This field is available only when EAP method has been set to TLS. It displays information on the user private key on the NPort.

WLAN Log Settings

MOXA® Total Solution for Industrial Device Networking www.moxa.com

■ Model	- NPort W2250A-W4-US	■ IP	- 192.168.126.254	■ MAC Address	- 00:90:E8:11:45:A3
■ Name	- NPortW2250A-W4_77	■ Serial No.	- TBBKB0000077	■ Firmware	- 0.1 Build 22071215
■ Location	-				

WLAN Log Settings

WLAN Log Settings

WLAN Log

- Main Menu
 - Overview
 - Wizard
 - Basic Settings
 - Network Settings
 - General Settings
 - Ethernet/Bridge Settings
 - WLAN Settings
 - WLAN
 - Profile
 - WLAN Log Settings

WLAN Log Settings

Default	Disable
Options	Disable, Enable
Description	When the wireless connection between the device server and the AP is not stable, you may enable this function to have more information for troubleshooting. You may find System Monitoring → System Status → WLAN Log for the detail logs. Before calling for help from Moxa, please enable this function to collect some information.

Advanced Settings

On the **Advanced Settings** page in the **Network Settings** folder, you can change **Gratuitous ARP**. For this function, the NPort will actively send ARP packets to inform the devices in the network on how to find the NPort. If you enable Ethernet/Bridge mode, you can input the IP/MAC address of the legacy device that is connected to the Ethernet port of the NPort. The NPort will help to send out the ARP packets with its IP address to inform the network on how to find this legacy device.

Gratuitous ARP

Default	Enabled
Options	Enable / Disable
Description	Gratuitous ARP requests provide duplicate IP address detection. The NPort sends broadcast packets to update ARP tables on other devices (e.g., AP, PC) periodically. We can use this function to notify networked devices that the NPort is still alive. Moreover, the NPort can send Gratuitous ARP for legacy devices that do not have this function. If you want the NPort to send Gratuitous ARP for legacy devices, enter the legacy devices' IP and Mac addresses in IP/MAC address field.

Send Period

Default	180 seconds
Options	10-1000 seconds
Description	This field specifies how long the NPort periodically sends Gratuitous ARP.

IP/MAC Addresses

Default	N/A
Options	IP address and MAC address of the legacy device (e.g., IP: "192.168.1.1", MAC: "11:22:33:44:AA:11"). This function is only available when Ethernet Bridge is enabled.
Description	IP address: legacy device IP address. MAC address: legacy devices MAC address.

8. Web Console: Serial Port Settings

Overview

This chapter explains how to configure all settings located under the **Serial Port Settings** folder in the NPort web console.

Serial Port Settings

Operation Modes

The screenshot shows the Moxa web console interface. At the top, there is a header with the Moxa logo, the tagline "Total Solution for Industrial Device Networking", and the website URL "www.moxa.com". Below the header is a status bar displaying system information: Model (NPort W2250A-W4-US), Name (NPortW2250A-W4_77), Location (-), IP (192.188.126.254), Serial No. (TBBKB0000077), MAC Address (00:90:E8:11:45:A3), and Firmware (0.1 Build 22071215). The main content area is titled "Operation Mode" and contains a table with columns: Port, Operating mode, Packet length, Delimiter 1, Delimiter 2, Delimiter process, and Force transmit. The table has two rows for ports 1 and 2, both set to "Real COM". A sidebar menu on the left lists various settings, with "Serial Port Settings" and its sub-item "Operation Mode" circled in red.

Port	Operating mode	Packet length	Delimiter 1	Delimiter 2	Delimiter process	Force transmit
1	Real COM	0	00 (Disable)	00 (Disable)	Do Nothing	0
		Max connection:	1			
2	Real COM	0	00 (Disable)	00 (Disable)	Do Nothing	0
		Max connection:	1			

Each serial port on the NPort is configured through the hyperlink below the column of **Operating mode**.

This screenshot is identical to the one above, showing the "Operation Mode" page. In this view, the "Real COM" link in the "Operating mode" column for port 1 is circled in red, indicating the link to be clicked.

Click the link of **Real COM**. It will show the Port settings page. The Operation Modes page for each serial port is where you configure the serial port's operation mode and related settings. For an introduction to the different operation modes, please refer to Chapter 4.

■ Model	- NPort W2250A-W4-US	■ IP	- 192.168.126.254	■ MAC Address	- 00:90:E8:11:45:A3
■ Name	- NPortW2250A-W4_77	■ Serial No.	- TBBKB0000077	■ Firmware	- 0.1 Build 22071215
■ Location	-				

Operation Mode

- Main Menu

- Overview
- Wizard
- Basic Settings
- Network Settings
 - General Settings
 - Ethernet/Bridge Settings
 - WLAN Settings
 - Advanced Settings
- Serial Port Settings
 - Operation Mode
 - Communication Parameters
 - Data Buffering/Log
- System Management
- System Monitoring
- Restart

Port Settings

Port: 1

Operation mode: Real COM

TCP alive check time: (0 - 99 min)

Max connection: 1

Ignore jammed IP: Disable

Allow driver control: Disable

Connection goes down: RTS always low always high
 DTR always low always high

Data Packing

Packet length: (0 - 1024)

Delimiter 1: (HEX) Enable

Delimiter 2: (HEX) Enable

Delimiter process: Do Nothing (Processed only when packet length is 0)

Force transmit: (0 - 65535 ms)

Apply the above settings to all serial ports

Submit

Operation Mode

Default	Real COM
Options	Real COM, RFC2217, TCP Server, TCP Client, UDP, Pair_Master, Pair_Slave, EModem
Description	<p>Along with the application, this field specifies the serial port's operation mode, or how it will interact with network devices. Depending on how the application is configured, different options are available for Operation Mode. Depending on how Mode is configured, additional settings will be available for configuration. For an introduction to the different operation modes, please refer to Chapter 4. Real COM: This serial port will operate in Real COM mode.</p> <p>RFC2217: This serial port will operate in RFC2217 mode.</p> <p>TCP Server: This serial port will operate in TCP Server mode.</p> <p>TCP Client: This serial port will operate in TCP Client mode.</p> <p>UDP: This serial port will operate in UDP mode.</p> <p>Pair_Master: This serial port will operate in Pair Connection Master mode.</p> <p>Pair_Slave: This serial port will operate in Pair Connection Slave mode.</p> <p>EModem: This serial port will operate in Ethernet Modem mode.</p>

Settings for Real COM Mode

The screenshot shows the Moxa web interface for configuring a serial port. The top navigation bar includes the Moxa logo, the tagline 'Total Solution for Industrial Device Networking', and the website 'www.moxa.com'. A status bar at the top right displays system information: Model (NPort W2250A-W4-US), Name (NPortW2250A-W4_77), Location (-), IP (192.168.128.254), Serial No. (TBBKB0000077), MAC Address (00:80:E8:11:45:A3), and Firmware (0.1 Build 22071215). The main content area is titled 'Operation Mode' and is divided into 'Port Settings' and 'Data Packing' sections. The 'Port Settings' section includes fields for Port (1), Operation mode (Real COM, circled in red), TCP alive check time (7 min), Max connection (1), Ignore jammed IP (Disable), Allow driver control (Disable), and Connection goes down (RTS/DTR always high). The 'Data Packing' section includes Packet length (0), Delimiter 1 and 2 (00), Delimiter process (Do Nothing), and Force transmit (0). A 'Submit' button is located at the bottom right of the settings area.

When **Operation Mode** is set to Real COM on a serial port's **Operation Modes** page, you will configure additional settings including **TCP alive check time**, **Max connection**, **Ignore jammed IP**, **Allow driver Control**, **Connection goes down**, **Packet length**, **Delimiter 1**, **Delimiter 2**, **Delimiter process**, and **Force transmit**.

TCP Alive Check Time

Default	7 min
Options	0 to 99 min
Description	<p>This field specifies how long the NPort will wait for a response to "keep-alive" packets before closing the TCP connection. The NPort checks connection status by sending periodic "keep- alive" packets.</p> <p>0: The TCP connection will remain open even if there is no response to the "keep-alive" packets.</p> <p>1 to 99: If the remote host does not respond to the packet within the specified time, the NPort will force the existing TCP connection to close.</p>

Max Connection

Default	1
Options	1 to 8
Description	<p>This field specifies the maximum number of connections the serial port will accept.</p> <p>1: Only one specific host can access this serial port, and the Real COM driver on that host will have full control over the port.</p> <p>2 to 8: This serial port will allow the specified number of connections to be opened simultaneously. With simultaneous connections, the Real COM driver will only provide a pure data tunnel with no control ability. The serial communication will be determined by the NPort rather than by your application program. Application software that is based on the Real COM driver will receive a driver response of "success" when using any of the Win32 API functions. The NPort will send data only to the Real COM driver on the host. Data received from hosts will be sent to the attached serial device on a first-in-first-out basis.</p>



ATTENTION

When Max connection is two or greater, the serial port's communication settings (i.e., baudrate, parity, data bits, etc.) will be determined by the NPort. Any host that opens the COM port connection must use identical serial communication settings.

Ignore Jammed IP

Default	Disable
Options	Disable, Enable
Description	<p>This field specifies how an unresponsive IP address is handled when there are simultaneous connections to the serial port.</p> <p>Disable: All transmissions will be suspended if one IP address becomes unresponsive. Transmission will only resume when all hosts have responded.</p> <p>Enable: Data transmission to the other hosts will not be suspended if one IP address becomes unresponsive.</p>

Allow Driver Control

Default	Disable
Options	Disable, Enable
Description	<p>This field specifies how the port will proceed if driver control commands are received from multiple hosts that are connected to the port.</p> <p>Disable: Driver control commands will be ignored.</p> <p>Enable: Control commands will be accepted, with the most recent command received taking precedence.</p>

Connection Goes Down

Default	always high
Options	always low, always high
Description	<p>This field specifies what happens to the RTS and DTR signals when the Ethernet connection goes down. For some applications, serial devices need to know the Ethernet link status through RTS or DTR signals sent through the serial port.</p> <p>Always low: The selected signal will change to low when the Ethernet connection goes down.</p> <p>Always high: The selected signal will remain high when the Ethernet connection goes down.</p>

Packet Length

Default	0
Options	0 to 1024
Description	<p>This field specifies the maximum amount of data that is allowed to accumulate in the serial port buffer before sending.</p> <p>0: Packet length is disregarded and data in the buffer will be sent as specified by the delimiter settings or when the buffer is full.</p> <p>1 to 1024: Data in the buffer will be sent as soon it reaches the specified length.</p>

Delimiter 1 and 2

Default	Disabled
Options	Disabled, Enabled, 00 to FF
Description	<p>These fields are used to define special delimiter character(s) for data packing. Enable Delimiter 1 to control data packing with a single character; enable both Delimiter 1 and 2 to control data packing with two characters received in sequence.</p> <p>When these fields are enabled, serial data will accumulate in the serial port's buffer until the buffer is full or until the specified delimiter character(s) are received. For example, the carriage return character could be used as a delimiter in order to transmit each sentence or paragraph in a separate packet. Data will be packed according to the Delimiter process.</p> <p>Delimiters must be incorporated into the data stream at the software or device level.</p>



ATTENTION

When **Delimiter 1** is enabled, **Packet length** must be set to 0.

Delimiter Process

Default	Do Nothing
Options	Do Nothing, Delimiter + 1, Delimiter + 2, Strip Delimiter
Description	<p>This field specifies how data is packed when delimiter characters are received. This field has no effect if Delimiter 1 is not enabled.</p> <p>Do nothing: Data accumulated in the serial port's buffer will be packed, including delimiters.</p> <p>Delimiter + 1: One additional character must be received before the data in the serial port's buffer is packed.</p> <p>Delimiter + 2: Two additional characters must be received before the data in the serial port's buffer is packed.</p> <p>Strip Delimiter: Data accumulated in the serial port's buffer will be packed, but the delimiter character(s) will be stripped from the data.</p>

Force Transmit

Default	0 ms
Options	0 to 65535
Description	<p>This field controls data packing by the time that elapses between bits of data. When using this field, make sure that Inactivity time is disabled or set to a larger value. Otherwise, the connection may be closed before the data in the buffer can be transmitted.</p> <p>0: If serial data is not received, the NPort will wait indefinitely for additional data.</p> <p>1 to 65535: If serial data is not received for the specified amount of time, the data that is currently in the buffer will be packed for network transmission. The optimal force transmit time depends on your application, but it must be at least larger than one character interval within the specified baudrate. For example, assume that the serial port is set to 1200 bps, 8 data bits, 1 stop bit, and no parity. In this case, the total number of bits needed to send a character is 10 bits, and the time required to transfer one character is 8.3 ms, so the force transmit time must be larger than 8.3 ms.</p>

Settings for RFC2217 Mode

The screenshot shows the MOXA web interface for configuring a serial port. The top navigation bar includes the MOXA logo, the slogan 'Total Solution for Industrial Device Networking', and the website 'www.moxa.com'. A status bar at the top right displays system information: Model (NPort W2250A-W4-US), Name (NPortW2250A-W4_77), Location (-), IP (192.168.128.254), Serial No. (TBBKB0000077), MAC Address (00:80:E8:11:45:A3), and Firmware (0.1 Build 22071215). The main content area is titled 'Operation Mode' and contains a 'Port Settings' section for port 1. The 'Operation mode' dropdown menu is highlighted with a red circle and set to 'RFC2217'. Other settings include 'TCP alive check time' (7 min), 'TCP port' (4001), 'Data Packing' section with 'Packet length' (0), 'Delimiter 1' (00), 'Delimiter 2' (00), 'Delimiter process' (Do Nothing), and 'Force transmit' (0). A 'Submit' button is located at the bottom right of the settings area.

When **Operation Mode** is set to **RFC2217** on a serial port's **Operation Modes** page, you will configure additional settings, including **TCP alive check time**, **TCP port**, **Packet length**, **Delimiter 1**, **Delimiter 2**, **Delimiter process**, and **Force transmit**.

TCP Alive Check Time

Default	7 min
Options	0 to 99 min
Description	This field specifies how long the NPort will wait for a response to "keep-alive" packets before closing the TCP connection. The NPort checks connection status by sending periodic "keep-alive" packets. 0: The TCP connection will remain open even if there is no response to the "keep-alive" packets. 1 to 99: If the remote host does not respond to the packet within the specified time, the NPort will force the existing TCP connection to close.

TCP Port

Default	4001
Options	
Description	This field specifies the TCP port number that the serial port will use to listen to connections, and that other devices must use to contact the serial port.

Packet Length

Default	0
Options	0 to 1024
Description	This field specifies the maximum amount of data that is allowed to accumulate in the serial port buffer before sending. 0: Packet length is disregarded and data in the buffer will be sent as specified by the delimiter settings or when the buffer is full. 1 to 1024: Data in the buffer will be sent as soon it reaches the specified length.

Delimiter 1 and 2

Default	Disabled
Options	Disabled, Enabled, 00 to FF
Description	<p>These fields are used to define special delimiter character(s) for data packing. Enable Delimiter 1 to control data packing with a single character; enable both Delimiter 1 and 2 to control data packing with two characters received in sequence.</p> <p>When these fields are enabled, serial data will accumulate in the serial port's buffer until the buffer is full or until the specified delimiter character(s) are received. For example, the carriage return character could be used as a delimiter in order to transmit each sentence or paragraph in a separate packet. Data will be packed according to the Delimiter process. Delimiters must be incorporated into the data stream at the software or device level.</p>

Delimiter Process

Default	Do Nothing
Options	Do Nothing, Delimiter + 1, Delimiter + 2, Strip Delimiter
Description	<p>This field specifies how data is packed when delimiter characters are received. This field has no effect if Delimiter 1 is not enabled.</p> <p>Do nothing: Data accumulated in the serial port's buffer will be packed, including delimiters.</p> <p>Delimiter + 1: One additional character must be received before the data in the serial port's buffer is packed.</p> <p>Delimiter + 2: Two additional characters must be received before the data in the serial port's buffer is packed.</p> <p>Strip Delimiter: Data accumulated in the serial port's buffer will be packed, but the delimiter character(s) will be stripped from the data.</p>

Force Transmit

Default	0 ms
Options	0 to 65535
Description	<p>This field controls data packing by the time that elapses between bits of data. When using this field, make sure that Inactivity time is disabled or set to a larger value. Otherwise, the connection may be closed before the data in the buffer can be transmitted.</p> <p>0: If serial data is not received, the NPort will wait indefinitely for additional data.</p> <p>1 to 65535: If serial data is not received for the specified amount of time, I will pack the data that is currently in the buffer for network transmission. The optimal force transmit time depends on your application, but it must be at least larger than one character interval within the specified baudrate. For example, assume that the serial port is set to 1200 bps, 8 data bits, 1 stop bit, and no parity. In this case, the total number of bits needed to send a character is 10 bits, and the time required to transfer one character is 8.3 ms, so the force transmit time must be larger than 8.3 ms.</p>

Settings for TCP Server Mode

The screenshot shows the MOXA web interface for configuring a serial port. The top navigation bar includes the MOXA logo, the slogan 'Total Solution for Industrial Device Networking', and the website 'www.moxa.com'. Below this is a status bar with system information: Model (NPort W2250A-W4-US), Name (NPortW2250A-W4_77), Location, IP (192.168.128.254), Serial No. (TBBKB0000077), MAC Address (00-90-E8-11-45-A3), and Firmware (0.1 Build 22071215). The main content area is titled 'Operation Mode' and is divided into two sections: 'Port Settings' and 'Data Packing'. In the 'Port Settings' section, the 'Operation mode' dropdown menu is highlighted with a red circle and set to 'TCP Server'. Other settings include 'TCP alive check time' (7 min), 'Inactivity time' (0 ms), 'Max connection' (1), 'Ignore jammed IP' (Disable), 'Allow driver control' (Disable), 'TCP port' (4001), 'Cmd port' (966), and 'Connection goes down' options for RTS and DTR. The 'Data Packing' section includes 'Packet length' (0), 'Delimiter 1' and 'Delimiter 2' (00), 'Delimiter process' (Do Nothing), and 'Force transmit' (0). A 'Submit' button is located at the bottom of the settings area.

When **Operation Mode** is set to **TCP Server** on a serial port's **Operation Modes** page, configure additional settings such as **TCP alive check time**, **Inactivity time**, **Max connection**, **Ignore jammed IP**, **Allow driver control**, **TCP port**, **Cmd port**, **Connection goes down**, **Packet length**, **Delimiter 1**, **Delimiter 2**, **Delimiter process**, and **Force transmit**.

TCP Alive Check Time

Default	7 min
Options	0 to 99 min
Description	<p>This field specifies how long the NPort will wait for a response to “keep-alive” packets before closing the TCP connection. The NPort checks connection status by sending periodic “keep-alive” packets.</p> <p>0: The TCP connection will remain open even if there is no response to the “keep-alive” packets.</p> <p>1 to 99: If the remote host does not respond to the packet within the specified time, the NPort will force the existing TCP connection to close.</p>

Inactivity Time

Default	0 ms
Options	0 to 65535 ms
Description	<p>This field specifies the time limit for keeping the connection open if no data flows to or from the serial device.</p> <p>0: The connection will remain open even if data is never received. For many applications, the serial device may be idle for long periods of time, so 0 is an appropriate setting.</p> <p>1 to 65535: If there is no activity for the specified time, the connection will be closed. When adjusting this field, make sure that it is greater than the Force transmit time. Otherwise, the TCP connection may be closed before data in the buffer can be transmitted.</p>

Max Connection

Default	1
Options	1 to 8
Description	<p>This field specifies the maximum number of connections that the serial will accept port.</p> <p>1: Only one specific host can access this serial port, and the Real COM driver on that host will have full control over the port.</p> <p>2 to 8: This serial port will allow the specified number of connections to be opened simultaneously. With simultaneous connections, the Real COM driver will only provide a pure data tunnel with no control ability. The serial communication will be determined by the NPort rather than by your application program. Application software that is based on the Real COM driver will receive a driver response of "success" when using any of the Win32 API functions. The NPort will send data only to the Real COM driver on the host. Data received from hosts will be sent to the attached serial device on a first-in-first-out basis.</p>



ATTENTION

When Max connection is two or greater, the serial port's communication settings (i.e., baudrate, parity, data bits, etc.) will be determined by the NPort. Any host that opens the COM port connection must use identical serial communication settings.

Ignore Jammed IP

Default	Disable
Options	Disable, Enable
Description	<p>This field specifies how an unresponsive IP address is handled when there are simultaneous connections to the serial port.</p> <p>Disable: All transmission will be suspended if one IP address becomes unresponsive. Transmission will only resume when all hosts have responded.</p> <p>Enable: Data transmission to the other hosts will not be suspended if one IP address becomes unresponsive.</p>

Allow Driver Control

Default	Disable
Options	Disable, Enable
Description	<p>This field specifies how the port will proceed if driver control commands are received from multiple hosts that are connected to the port.</p> <p>Disable: Driver control commands will be ignored.</p> <p>Enable: Control commands will be accepted, with the most recent command received taking precedence.</p>

TCP Port

Default	4001
Options	0 to 9999
Description	This field specifies the TCP port number that the serial port will use to listen to connections, and that other devices must use to contact the serial port.

Cmd Port

Default	966
Options	
Description	This field specifies the TCP port number for listening to IP-Serial Lib commands from the host.

IP Serial Library Introduction

What is IP Serial Library?

IP Serial Library is a Windows library with frequently used serial command sets and subroutines. IP Serial Library reduces the complexity and poor efficiency of serial communication over TCP/IP. For example, Telnet can only transfer data, but it can't monitor or configure the serial line's parameters.

Why Use IP Serial Library?

For programmers who are familiar with serial communication, IP Serial Library provides well-designed function calls that have the same style as Moxa's PComm Library.

IP Serial Library is amazingly simple and easy to understand. By including it in your VB, C, or Delphi programming environment, you can program your own TCP/IP application with the ability to control serial communication parameters.

The NPort Serial Device Servers use 2 TCP ports for communication between the NPort and host computer's Real COM driver. The NPort uses a data port and command port to provide pure data transfer without decoding and encoding. Compared to using only one TCP port to control serial communication (such as RFC 2217), IP Serial Library uses a command port to communicate with NPort in user's program. IP Serial Library not only runs with excellent efficiency, but also runs with no decoding or encoding problems.

You can find the usage of other functions in the subsection of **Real COM** mode in page 7-4.

Connection Goes Down

Default	Always high
Options	Always low, always high
Description	This field specifies what happens to the RTS and DTR signals when the Ethernet connection goes down. For some applications, serial devices need to know the Ethernet link status through RTS or DTR signals sent through the serial port. Always low: The selected signal will change to low when the Ethernet connection goes down. Always high: The selected signal will remain high when the Ethernet connection goes down.

Packet Length

Default	0
Options	0 to 1024
Description	This field specifies the maximum amount of data that is allowed to accumulate in the serial port buffer before sending. 0: Packet length is disregarded and data in the buffer will be sent as specified by the delimiter settings or when the buffer is full. 1 to 1024: Data in the buffer will be sent as soon it reaches the specified length.

Delimiter 1 and 2

Default	Disabled
Options	Disabled, Enabled, 00 to FF
Description	These fields are used to define special delimiter character(s) for data packing. Enable Delimiter 1 to control data packing with a single character; enable both Delimiter 1 and 2 to control data packing with two characters received in sequence. When these fields are enabled, serial data will accumulate in the serial port's buffer until the buffer is full or until the specified delimiter character(s) are received. For example, the carriage-return character could be used as a delimiter in order to transmit each sentence or paragraph in a separate packet. Data will be packed according to the Delimiter process. Delimiters must be incorporated into the data stream at the software or device level.



ATTENTION

When **Delimiter 1** is enabled, **Packet length** must be set to 0.

Delimiter Process

Default	Do Nothing
Options	Do Nothing, Delimiter + 1, Delimiter + 2, Strip Delimiter
Description	<p>This field specifies how data is packed when delimiter characters are received. This field has no effect if Delimiter 1 is not enabled.</p> <p>Do nothing: Data accumulated in the serial port's buffer will be packed, including delimiters.</p> <p>Delimiter + 1: One additional character must be received before the data in the serial port's buffer is packed.</p> <p>Delimiter + 2: Two additional characters must be received before the data in the serial port's buffer is packed.</p> <p>Strip Delimiter: Data accumulated in the serial port's buffer will be packed, but the delimiter character(s) will be stripped from the data.</p>

Force Transmit

Default	0 ms
Options	0 to 65535
Description	<p>This field controls data packing by the time that elapses between bits of data. When using this field, make sure that Inactivity time is disabled or set to a larger value. Otherwise, the connection may be closed before the data in the buffer can be transmitted.</p> <p>0: If serial data is not received, the NPort will wait indefinitely for additional data.</p> <p>1 to 65535: If serial data is not received for the specified amount of time, the data that is currently in the buffer will be packed for network transmission. The optimal force transmit time depends on your application, but it must be at least larger than one character interval within the specified baudrate. For example, assume that the serial port is set to 1200 bps, 8 data bits, 1 stop bit, and no parity. In this case, the total number of bits needed to send a character is 10 bits, and the time required to transfer one character is 8.3 ms, so the force transmit time must be larger than 8.3 ms.</p>

Settings for TCP Client Mode

The screenshot shows the MOXA web interface for configuring a serial port. The top navigation bar includes the MOXA logo, the slogan 'Total Solution for Industrial Device Networking', and the website 'www.moxa.com'. A status bar at the top right lists device information: Model (NPort W2250A-W4-US), Name (NPortW2250A-W4_77), Location, IP (192.168.128.254), Serial No. (TBBKB0000077), MAC Address (00:90:E8:11:45:A3), and Firmware (0.1 Build 22071215). The left sidebar contains a 'Main Menu' with options like Overview, Wizard, Basic Settings, Network Settings, Serial Port Settings, Operation Mode, Communication Parameters, Data Buffering/Log, System Management, System Monitoring, and Restart. A 'goahead WEB SERVER' logo is also present. The main content area is titled 'Operation Mode' and shows settings for Port 1. The 'Operation mode' dropdown is highlighted with a red circle. Below it are fields for 'TCP alive check time' (7 min), 'Inactivity time' (0 ms), 'Ignore jammed IP' (Disable), 'Destination address 1-4' (all 4001), 'Designated local port 1-4' (5010-5013), and 'Connection control' (Startup/None). A 'Data Packing' section includes 'Packet length' (0), 'Delimiter 1' (00), 'Delimiter 2' (00), 'Delimiter process' (Do Nothing), and 'Force transmit' (0). A 'Submit' button is at the bottom.

When **Operation Mode** is set to **TCP Client** on a serial port's **Operation Modes** page, you will be able to configure additional settings such as **TCP alive check time**, **Inactivity time**, **Ignore jammed IP**, **Destination address 1-4**, **Designated local port 1-4**, **Connection control**, and **Packet length**, **Delimiter 1**, **Delimiter 2**, **Delimiter process**, and **Force transmit**.

TCP Alive Check Time

Default	7 min
Options	0 to 99 min
Description	<p>This field specifies how long the NPort will wait for a response to “keep-alive” packets before closing the TCP connection. The NPort checks connection status by sending periodic “keep-alive” packets.</p> <p>0: The TCP connection will remain open even if there is no response to the “keep-alive” packets.</p> <p>1 to 99: If the remote host does not respond to the packet within the specified time, the NPort will force the existing TCP connection to close.</p>

Inactivity Time

Default	0 ms
Options	0 to 65535 ms
Description	<p>This field specifies the time limit for keeping the connection open if no data flows to or from the serial device.</p> <p>0: The connection will remain open even if data is never received. For many applications, the serial device may be idle for long periods of time, so 0 is an appropriate setting.</p> <p>1 to 65535: If there is no activity for the specified time, the connection will be closed. When adjusting this field, make sure that it is greater than the Force transmit time. Otherwise, the TCP connection may be closed before data in the buffer can be transmitted.</p>

Ignore Jammed IP

Default	Disable
Options	Disable, Enable
Description	<p>This field specifies how an unresponsive IP address is handled when there are simultaneous connections to the serial port.</p> <p>Disable: All transmission will be suspended if one IP address becomes unresponsive. Transmission will only resume when all hosts have responded.</p> <p>Enable: Data transmission to the other hosts will not be suspended if one IP address becomes unresponsive.</p>

Destination Address 1 to 4

Default	
Options	IP address and port (e.g., "192.168.1.1" and "4001")
Description	This field specifies the remote host(s) that will access the attached device. At least one destination must be provided. This field supports the use of domain names and names defined in the host table.



ATTENTION

In TCP Client mode, up to four connections can be established between the serial port and TCP hosts. The connection speed or throughput may be low if any one of the four connections is slow, since the one slow connection will slow down the other three connections.

Designated Local Port 1 to 4

Default	
Options	1 to 65535
Description	This field specifies the TCP port number that will be used for data transmission with the serial port.

Connection Control

Default	Startup/None
Options	Startup/None, Any Character/None, Any Character/Inactivity Time, DSR On/DSR Off, DSR On/None, DCD On/DCD Off, DCD On/None
Description	<p>This field specifies how connections to the device are established and closed.</p> <p>Startup/None: The connection will be opened as the NPort starts up. The connection will only be closed manually.</p> <p>Any Character/None: The connection will be opened as soon as a character is received from the attached device. The connection will only be closed manually.</p> <p>Any Character/Inactivity Time: The connection will be opened as soon as a character is received from the attached device. The connection will be closed if no data is received for the time specified in the Inactivity time.</p> <p>DSR On/DSR Off: The TCP connection is opened when the DSR signal is on, and closed when the DSR signal is off.</p> <p>DSR On/None: The TCP connection is opened when the DSR signal is on. The connection will only be closed manually.</p> <p>DCD On/DCD Off: The TCP connection is opened when the DCD signal is on, and closed when the DCD signal is off.</p> <p>DCD On/None: The TCP connection is opened when the DCD signal is on. The connection will only be closed manually.</p>

Packet Length

Default	0
Options	0 to 1024
Description	<p>This field specifies the maximum amount of data that is allowed to accumulate in the serial port buffer before sending.</p> <p>0: Packet length is disregarded and data in the buffer will be sent as specified by the delimiter settings or when the buffer is full.</p> <p>1 to 1024: Data in the buffer will be sent as soon it reaches the specified length.</p>

Delimiter 1 and 2

Default	Disabled
Options	Disabled, Enabled, 00 to FF
Description	<p>These fields are used to define special delimiter character(s) for data packing. Enable Delimiter 1 to control data packing with a single character; enable both Delimiter 1 and 2 to control data packing with two characters received in sequence.</p> <p>When these fields are enabled, serial data will accumulate in the serial port's buffer until the buffer is full or until the specified delimiter character(s) are received. For example, the carriage-return character could be used as a delimiter in order to transmit each sentence or paragraph in a separate packet. Data will be packed according to the Delimiter process.</p> <p>Delimiters must be incorporated into the data stream at the software or device level.</p>



ATTENTION

When **Delimiter 1** is enabled, **Packet length** must be set to 0.

Delimiter Process

Default	Do Nothing
Options	Do Nothing, Delimiter + 1, Delimiter + 2, Strip Delimiter
Description	<p>This field specifies how data is packed when delimiter characters are received. This field has no effect if Delimiter 1 is not enabled.</p> <p>Do nothing: Data accumulated in the serial port's buffer will be packed, including delimiters.</p> <p>Delimiter + 1: One additional character must be received before the data in the serial port's buffer is packed.</p> <p>Delimiter + 2: Two additional characters must be received before the data in the serial port's buffer is packed.</p> <p>Strip Delimiter: Data accumulated in the serial port's buffer will be packed, but the delimiter character(s) will be stripped from the data.</p>

Force Transmit

Default	0 ms
Options	0 to 65535
Description	<p>This field controls data packing by the amount of time that elapses between bits of data. When using this field, make sure that Inactivity time is disabled or set to a larger value. Otherwise, the connection may be closed before the data in the buffer can be transmitted.</p> <p>0: If serial data is not received, the NPort will wait indefinitely for additional data.</p> <p>1 to 65535: If serial data is not received for the specified amount of time, the data that is currently in the buffer will be packed for network transmission. The optimal force transmit time depends on your application, but it must be at least larger than one character interval within the specified baudrate. For example, assume that the serial port is set to 1200 bps, 8 data bits, 1 stop bit, and no parity. In this case, the total number of bits needed to send a character is 10 bits, and the time required to transfer one character is 8.3 ms, so the force transmit time must be larger than 8.3 ms.</p>

Settings for UDP Mode

The screenshot shows the Moxa web interface for the NPort W2250A-W4. The top navigation bar includes the Moxa logo, the tagline 'Total Solution for Industrial Device Networking', and the website URL 'www.moxa.com'. Below this is a status bar with system information: Model (NPort W2250A-W4-US), Name (NPortW2250A-W4_77), Location, IP (192.168.128.254), Serial No. (TBBKB0000077), MAC Address (00:90:E8:11:45:A3), and Firmware (0.1 Build 22071215). The main content area is titled 'Operation Mode' and contains several sections: 'Port Settings' (Port 1, Operation mode: UDP, Destination addresses 1-4, Local listening port: 4001), 'Data Packing' (Packet length: 0, Delimiter 1 and 2: 00 (HEX), Delimiter process: Do Nothing, Force transmit: 0), and an 'Apply' checkbox. A 'Submit' button is at the bottom.

When **Operation Mode** is set to **UDP** on a serial port's **Operation Modes** page, configure additional settings such as **Destination address 1** through **4**, **Local listen port**, **Packet length**, **Delimiter 1**, **Delimiter 2**, **Delimiter process**, and **Force transmit**.

Destination Address 1 to 4

Default	
Options	IP address range and port (e.g., "192.168.1.1" to "192.168.1.64" and "4001")
Description	<p>In UDP mode, you may specify up to four ranges of IP addresses for the serial port to connect to. At least one destination range must be provided.</p> <p>The maximum selectable IP address range is 64 addresses. However, you can enter multicast addresses in the Begin field, in the form xxx.xxx.xxx.255. For example, enter "192.127.168.255" to allow the NPort to broadcast UDP packets to all hosts with IP addresses between 192.127.168.1 and 192.127.168.254.</p>

Local Listen Port

Default	4001
Options	
Description	This field specifies the UDP port that the NPort listens to and that other devices must use to contact the attached serial device.

Packet Length

Default	0
Options	0 to 1024
Description	<p>This field specifies the maximum amount of data that is allowed to accumulate in the serial port buffer before sending.</p> <p>0: Packet length is disregarded and data in the buffer will be sent as specified by the delimiter settings or when the buffer is full.</p> <p>1 to 1024: Data in the buffer will be sent as soon it reaches the specified length.</p>

Delimiter 1 and 2

Default	Disabled
Options	Disabled, Enabled, 00 to FF
Description	<p>These fields are used to define special delimiter character(s) for data packing. Enable Delimiter 1 to control data packing with a single character; enable both Delimiter 1 and 2 to control data packing with two characters received in sequence.</p> <p>When these fields are enabled, serial data will accumulate in the serial port's buffer until the buffer is full or until the specified delimiter character(s) are received. For example, the carriage return character could be used as a delimiter in order to transmit each sentence or paragraph in a separate packet. Data will be packed according to the Delimiter process.</p> <p>Delimiters must be incorporated into the data stream at the software or device level.</p>



ATTENTION

When **Delimiter 1** is enabled, **Packet length** must be set to 0.

Delimiter Process

Default	Do Nothing
Options	Do Nothing, Delimiter + 1, Delimiter + 2, Strip Delimiter
Description	<p>This field specifies how data is packed when delimiter characters are received. This field has no effect if Delimiter 1 is not enabled.</p> <p>Do nothing: Data accumulated in the serial port's buffer will be packed, including delimiters.</p> <p>Delimiter + 1: One additional character must be received before the data in the serial port's buffer is packed.</p> <p>Delimiter + 2: Two additional characters must be received before the data in the serial port's buffer is packed.</p> <p>Strip Delimiter: Data accumulated in the serial port's buffer will be packed, but the delimiter character(s) will be stripped from the data.</p>

Force Transmit

Default	0 ms
Options	0 to 65535
Description	<p>This field controls data packing by the amount of time that elapses between bits of data. When using this field, make sure that Inactivity time is disabled or set to a larger value. Otherwise, the connection may be closed before the data in the buffer can be transmitted.</p> <p>0: If serial data is not received, the NPort will wait indefinitely for additional data.</p> <p>1 to 65535: If serial data is not received for the specified amount of time, the data that is currently in the buffer will be packed for network transmission. The optimal force transmit time depends on your application, but it must be at least larger than one character interval within the specified baudrate. For example, assume that the serial port is set to 1200 bps, 8 data bits, 1 stop bit, and no parity. In this case, the total number of bits needed to send a character is 10 bits, and the time required to transfer one character is 8.3 ms, so the force transmit time must be larger than 8.3 ms.</p>

Settings for Pair Connection Master Mode and Pair Connection Slave Mode

The image displays two screenshots of the MOXA web interface, specifically the 'Operation Mode' configuration page for a serial port. Both screenshots show the same device information at the top: Model (NPort W2250A-W4-US), Name (NPortW2250A-W4_77), Location, IP (192.168.128.254), Serial No. (TBBKB0000077), MAC Address (00:90:E8:11:45:A3), and Firmware (0.1 Build 22071215).

Top Screenshot: Pair Connection Master Mode

- Port:** 1
- Operation mode:** Pair Connection Master (highlighted with a red circle)
- TCP alive check time:** 7 (0 - 99 min)
- Destination address:** (empty field)
- TCP port:** 4001
- Apply the above settings to all serial ports
- Submit** button

Bottom Screenshot: Pair Connection Slave Mode

- Port:** 1
- Operation mode:** Pair Connection Slave (highlighted with a red circle)
- TCP alive check time:** 7 (0 - 99 min)
- TCP port:** 4001
- Apply the above settings to all serial ports
- Submit** button

When **Operation Mode** is set to **Pair Connection Master** or **Pair Connection Slave** on a serial port's **Operation Modes** page, configure additional settings such as **TCP alive check time**, **Destination address** and **TCP port**. A Pair Connection application involves one serial port communicating over an IP network to another serial port as if a serial cable connected the two serial ports. Pair Connection modes can extend RS-232 transmission to unlimited distances.

An NPort device server is needed at both ends of the connection. The serial port at one end must be set to Pair Connection Master mode, and the serial port at the other end must be set to Pair Connection Slave mode. It does not matter which serial port is master and which serial port is slave.

TCP Alive Check Time

Default	7 min
Options	0 to 99 min
Description	<p>This field specifies how long the NPort will wait for a response to “keep-alive” packets before closing the TCP connection. The NPort checks connection status by sending periodic “keep-alive” packets.</p> <p>0: The TCP connection will remain open even if there is no response to the “keep-alive” packets.</p> <p>1 to 99: If the remote host does not respond to the packet within the specified time, the NPort will force the existing TCP connection to close.</p>

Destination Address

Default	
Options	IP address and port (e.g., “192.168.1.1” and “4001”)
Description	This field specifies the IP address for the NPort at the opposite end of the Pair Connection, and the TCP port number for communication with the serial port. The port number must match with that serial port’s TCP port setting.

TCP Port

Default	4001
Options	
Description	This field specifies the TCP port to use for communication with the attached serial device. The serial port at the opposite end of the Pair Connection must use this port number to establish the connection.

Settings for Ethernet Modem Mode

The screenshot shows the Moxa web interface for configuring an NPort. At the top, the Moxa logo and tagline "Total Solution for Industrial Device Networking" are visible, along with the website URL "www.moxa.com". Below this is a status bar with system information: Model (NPort W2250A-W4-US), Name (NPortW2250A-W4_77), Location, IP (192.168.126.254), Serial No. (TBBKB0000077), MAC Address (00:80:E8:11:45:A3), and Firmware (0.1 Build 22071215). The main content area is titled "Operation Mode" and shows "Port Settings" for Port 1. The "Operation mode" dropdown menu is set to "Ethernet Modem" and is highlighted with a red circle. Below it, the "TCP alive check time" is set to 7 (0-99 min) and the "TCP port" is set to 4001. There is a checkbox for "Apply the above settings to all serial ports" which is currently unchecked, and a "Submit" button at the bottom.

When **Application** is set to **Ethernet Modem Mode**, the NPort will accept AT commands such as “ATD 192.127.168.1:4001” from the serial port. A TCP connection will then be requested from the specified remote Ethernet Modem or PC. When the remote unit accepts this TCP connection, the NPort will return the “**CONNECT {baudrate}**” signal to the serial port and will then enter data mode. Please refer to Appendix C for details on Ethernet modem commands.

TCP Alive Check Time

Default	7 min
Options	0 to 99 min
Description	<p>This field specifies how long the NPort will wait for a response to “keep-alive” packets before closing the TCP connection. The NPort checks connection status by sending periodic “keep-alive” packets.</p> <p>0: The TCP connection will remain open even if there is no response to the “keep-alive” packets.</p> <p>1 to 99: If the remote host does not respond to the packet within the specified time, the NPort will force the existing TCP connection to close.</p>

TCP Port

Default	4001
Options	
Description	This field specifies the TCP port to use for communication with the attached serial device.

Settings for Reverse Terminal Mode

The screenshot shows the Moxa web interface for configuring an NPort. The top navigation bar includes the Moxa logo, the tagline 'Total Solution for Industrial Device Networking', and the website URL 'www.moxa.com'. Below this is a status bar with system information: Model (NPort W2250A-W4-US), Name (NPortW2250A-W4_77), Location, IP (192.168.128.254), Serial No. (TBBKB0000077), MAC Address (00:90:E8:11:45:A3), and Firmware (0.1 Build 22071215). The main content area is titled 'Operation Mode' and contains several configuration sections: 'Port Settings' (Port: 1, Operation mode: Reverse Terminal, TCP alive check time: 7 min, Inactivity time: 0 min, TCP port: 4001), 'Terminal' (Authentication type: None, Map keys: CR-LF), and a 'Submit' button. A sidebar on the left provides a 'Main Menu' with options like Overview, Wizard, Basic Settings, Network Settings, Serial Port Settings, Operation Mode, Communication Parameters, Data Buffering/Log, System Management, System Monitoring, and Restart. A 'goahead WEB SERVER' logo is visible at the bottom left of the sidebar.

TCP alive check time (default=7 min): This field specifies how long the NPort W2150A-W4/W2250A-W4 will wait for a response to keep-alive packets before closing the TCP connection. The NPort W2150A-W4/W2250A-W4 checks the connection status by sending keep-alive packets periodically. If the remote host does not respond to the packet within the time specified in this field, the NPort W2150A-W4/W2250A-W4 will force the existing TCP connection to close. For socket and device control modes, the NPort W2150A-W4/W2250A-W4 will listen for another TCP connection from another host after closing the connection. If the TCP alive check time is set to 0, the TCP connection will remain open even if there is no response to the keep-alive packets.

Inactivity time (default=0 min): This field specifies the idle time setting for auto-disconnection. A setting of 0 min. will cause the port to remain connected even when idling.

TCP port (default=4001): This is the TCP port number assignment for the serial port on the NPort W2150A-W4/W2250A-W4. It is the port number that the serial port uses to listen to connections and that other devices must use to contact the serial port. To avoid conflict with well-known TCP ports, the default is set to 4001.

Authentication type (default=None): This field allows you to configure the method used, if any, to verify a user’s ID and authorization.

Option	Description
None	Authentication is not required
Local	Verify the ID against the NPort W2150A-W4/W2250A-W4 User Table.
RADIUS	Verify the ID against the external RADIUS server.

Try next type on authentication denied (default=Disable): This field enables or disables the system to try the next type if the first authentication is denied.

Map keys <CR-LF> (default=CR-LF): This specifies how the **ENTER** key is mapped from the Ethernet port through the serial port.

Option	Description
<CR-LF>	Carriage return + line feed (i.e., the cursor will jump to the next line and return to the first character of the line)
<CR>	Carriage return (i.e., the cursor will return to the first character of the line)
<LF>	Line feed (i.e., the cursor will jump to the next line, but not move horizontally)

Communication Parameters

The **Communication Parameters** page for each serial port is where serial communication settings are specified, such as **Baud rate**, **Data bits**, and **Stop bits**.

Alias

Default	
Options	free text (e.g., "Secondary console connection")
Description	This is an optional free text field to help you differentiate one serial port from another. It does not affect the operation of the NPort device server.



ATTENTION

Serial communication settings should match the attached serial device. Check the communication settings in the user's manual for your serial device.

Baud Rate

Default	115200
Options	300, 600, 1200, 1800, 2400, 4800, 9600, 19200, 38400, 57600, 115200, 230400, 460800, 921600, Other
Description	This field specifies the baudrate for the serial port. Nonstandard baudrates are supported through the Other setting. When set to Other , you may manually enter a baudrate of your choice, up to 921600. 300 to 921600: The serial port will operate at the specified baudrate. Other: The serial port will operate at a baudrate that is manually entered by the user.

Parity

Default	None
Options	None, Odd, Even, Space, Mark
Description	This field specifies the type of parity bit used for each character frame.

Data Bit

Default	8
Options	5, 6, 7, 8
Description	This field specifies the number of data bits used to encode each character of data.

Stop Bit

Default	1
Options	1, 1.5, 2
Description	This field specifies the number of stop bits used for each character frame.

Flow Control

Default	RTS/CTS
Options	None, RTS/CTS, XON/XOFF
Description	This field specifies the type of flow control used by the serial port.

FIFO

Default	Enable
Options	Enable, Disable
Description	This field specifies whether the serial port will use the built-in FIFO. A 128-byte FIFO is provided to each serial port for both Tx and Rx directions. To prevent data loss during serial communication, this should be set to Disabled if the attached serial device does not have a FIFO.

Interface

Default	RS-232
Options	RS-232, RS-422, RS-485 2-wire, RS-485 4-wire
Description	This field specifies the type of interface the serial port will use.

Data Buffering/Log

The screenshot shows the MOXA web interface for the Data Buffering/Log configuration. At the top, there is a status bar with system information: Model (NPort W2250A-W4-US), Name (NPortW2250A-W4_77), Location, IP (192.168.128.254), Serial No. (TBBKB0000077), MAC Address (00:90:E8:11:45:A3), and Firmware (0.1 Build 22071215). The main content area is titled "Data Buffering/Log" and features a "Port" dropdown menu with options for "Port 1", "Port 2", and "All Ports". Below this, there are two columns of settings: "Port buffering (10M)" and "Serial data logging (64K)". Each column has three "Disable" buttons corresponding to the port options. A "Submit" button is located at the bottom of the settings area. On the left, a navigation menu is visible, with "Data Buffering/Log" circled in red.

On the serial port's **Data Buffering/Log** page, you can enable or disable **Port buffering** and **Serial data logging**.

Port Buffering

Default	Disable
Options	Enable, Disable
Description	This field specifies whether the serial port will use port buffering when the network connection (Ethernet or WLAN) is down. Port buffering can be used in Real COM mode, TCP Server mode, TCP Client mode, and Pair Connection mode. For other modes, the port buffering settings will have no effect.

Serial Data Logging(64K)

Default	Disable
Options	Enable, Disable
Description	This field specifies whether data logs for the serial port will be stored on system RAM. Each serial port is allotted 64 KB for data logging. The data log is not saved when the NPort is powered off.

9. Web Console: System Management

Overview

This chapter explains how to configure all settings located under the **System Management** folder in the NPort web console.

System Management

Misc. Network Settings

Accessible IP List

The screenshot shows the Moxa web console interface. At the top, there is a header with the Moxa logo, the text "Total Solution for Industrial Device Networking", and the website "www.moxa.com". Below the header, there is a green bar containing system information: Model (NPort W2250A-W4-US), Name (NPortW2250A-W4_77), Location, IP (192.168.128.254), Serial No. (TBBKB0000077), MAC Address (00:90:E8:11:45:A3), and Firmware (0.1 Build 22071215). The main content area is titled "Accessible IP List" and features a checkbox labeled "Enable the accessible IP list ('Disable' will allow all IP's connection requests.)". Below this is a table with four columns: "No.", "Active", "IP", and "Netmask". The table contains 10 rows, each with an "Active" checkbox and input fields for "IP" and "Netmask". The "Accessible IP List" option in the left-hand navigation menu is circled in red.

The **Accessible IP List** page is located under **Misc. Network Settings** in the **System Management** folder. This page is used to restrict access to the NPort by IP address. Only IP addresses on the list will be allowed access to the NPort. You may add a specific address or range of addresses by using a combination of IP address and netmask, as follows:

To allow access to a specific IP address

Enter the IP address in the corresponding field; enter 255.255.255.255 for the netmask.

To allow access to hosts on a specific subnet

For both the IP address and netmask, use 0 for the last digit (e.g., "192.168.1.0" and "255.255.255.0").

To allow access to all IP addresses

Make sure that **Enable the accessible IP list** is not checked.

Refer to the following table for more configuration examples.

Desired IP Range	IP Address Field	Netmask Field
Any host	Disable	Disable
192.168.1.120	192.168.1.120	255.255.255.255
192.168.1.1 to 192.168.1.254	192.168.1.0	255.255.255.0
192.168.0.1 to 192.168.255.254	192.168.0.0	255.255.0.0
192.168.1.1 to 192.168.1.126	192.168.1.0	255.255.255.128
192.168.1.129 to 192.168.1.254	192.168.1.128	255.255.255.128

SNMP Agent Settings

The **SNMP Agent** page is located under **Misc. Network Settings** in the **System Management** folder. This page is used to configure the SNMP Agent on the NPort.

SNMP

Default	Enable
Options	Enable, Disable
Description	This field enables or disables the SNMP Agent. If enabled, you will need to configure other SNMP Agent settings. You will need to enter a community name under Read community string.

Contact Name

Default	
Options	free text (e.g., "J Smith")
Description	This is an optional free text field that can specify the SNMP emergency contact name, telephone, or pager number.

Location

Default	
Options	free text (e.g., "Building XYZ")
Description	This is an optional free text field that can specify the location for SNMP agents, such as the NPort.

Read Community String

Default	public
Options	free text (e.g., "public community")
Description	This field specifies the read community string used for the SNMP Agent. This is a text password mechanism that is used to weakly authenticate queries to agents of managed network devices.

Write Community String

Default	Private
Options	free text (e.g., "private community")
Description	This field specifies the write community string used for the SNMP Agent. This is a text password mechanism that is used to weakly authenticate changes to agents of managed network devices.

SNMP Agent Version

Default	V1, V2c, V3
Options	V1, V2c, V3 / V1, V2c / V3 only
Description	This field specifies which version(s) of SNMP to support.

Read Only Username

Default	Rouser
Options	free text (e.g., "guest")
Description	This field specifies a username to use for read-only access.

Read Only Authentication Mode

Default	Disable
Options	Disable, MD5, SHA
Description	This field specifies the type of authentication to use for read-only access.

Read Only Password

Default	
Options	Free text (e.g., "password123")
Description	This field specifies the password that users must enter for read-only access, if read-only authentication is enabled.

Read Only Privacy Mode

Default	Disable
Options	Disable
Description	This field specifies whether data encryption will be used during read-only access.

Read Only Privacy

Default	
Options	Free text (e.g., "read only key")
Description	This field specifies the encryption key for read-only access, if read-only privacy is enabled.

Read/Write Username

Default	rwuser
Options	free text (e.g., "admin")
Description	This field specifies a username to use for read/write access.

Read/Write Authentication Mode

Default	Disable
Options	Disable, MD5, SHA
Description	This field specifies the type of authentication to use for read/write access.

Read/Write Password

Default	
Options	Free text (e.g., "password123")
Description	This field specifies the password that users must enter for read/write access, if read-only authentication is enabled.

Read/Write Privacy Mode

Default	Disable
Options	Disable, DES, AES
Description	This field specifies whether data encryption will be used during read/write access.

Read/Write Privacy

Default	
Options	free text (e.g., "read write key")
Description	This field specifies the encryption key for read/write access, if read-/write privacy is enabled.

User Table

The screenshot shows the Moxa web interface for the NPort W2250A-W4 series. The top navigation bar includes the Moxa logo, the slogan 'Total Solution for Industrial Device Networking', and the website 'www.moxa.com'. Below this is a status bar with system information: Model (NPort W2250A-W4-US), Name (NPortW2250A-W4_77), Location (-), IP (192.168.128.254), Serial No. (TBBKB0000077), MAC Address (00:90:E8:11:45:A3), and Firmware (0.1 Build 22071215). The main content area is titled 'User Table' and contains a table with 9 rows. The columns are 'No.', 'Username', and 'Password'. The 'User Table' option in the left-hand menu is circled in red.

No.	Username	Password
1	<input type="text"/>	<input type="text"/>
2	<input type="text"/>	<input type="text"/>
3	<input type="text"/>	<input type="text"/>
4	<input type="text"/>	<input type="text"/>
5	<input type="text"/>	<input type="text"/>
6	<input type="text"/>	<input type="text"/>
7	<input type="text"/>	<input type="text"/>
8	<input type="text"/>	<input type="text"/>
9	<input type="text"/>	<input type="text"/>

The NPort User Table can authenticate users for reverse terminal access and is useful if you do not have an external RADIUS server for authentication. The NPort User Table stores up to 64 entries, with fields for User Name and Password.

Authentication Server

The screenshot shows the Moxa web interface for the NPort W2250A-W4 series. The top navigation bar includes the Moxa logo, the slogan 'Total Solution for Industrial Device Networking', and the website 'www.moxa.com'. Below this is a status bar with system information: Model (NPort W2250A-W4-US), Name (NPortW2250A-W4_77), Location (-), IP (192.168.128.254), Serial No. (TBBKB0000077), MAC Address (00:90:E8:11:45:A3), and Firmware (0.1 Build 22071215). The main content area is titled 'Authentication Server' and contains a form with the following fields: 'RADIUS server' (text input), 'RADIUS key' (text input), 'UDP port' (dropdown menu set to 1645), and 'RADIUS accounting' (dropdown menu set to Disable). A 'Submit' button is located below the form. The 'Authentication Server' option in the left-hand menu is circled in red.

RADIUS server: If you are using a RADIUS server for user authentication, enter its IP address here.

RADIUS key: If you are using a RADIUS server for user authentication, enter its password here.

UDP port (default=1645): Please select which UDP port your RADIUS server is using to communicate. The device supports UDP port 1645 or 1812.

RADIUS accounting: Use this field to enable or disable RADIUS accounting.

System Log Settings

MOXA® Total Solution for Industrial Device Networking www.moxa.com

Model - NPort W2250A-W4-US IP - 192.168.128.254 MAC Address - 00:90:E8:11:45:A3
 Name - NPortW2250A-W4_77 Serial No. - TBBKB0000077 Firmware - 0.1 Build 22071215
 Location -

System Log Settings

Event Group	Local Log	Summary
System	<input type="checkbox"/>	System Cold Start, System Warm Start
Network	<input type="checkbox"/>	DHCP Get IP/Renew, Mail Failure, NTP Connection Failure, IP Conflict, Network Link Down
Config	<input type="checkbox"/>	Login Failure, IP Changed, Password Changed, Firmware Upgrade, SSL Certificate Import, Config Import, Config Export, Wireless Certificate Import, Serial Data Log Export
OpMode	<input type="checkbox"/>	Connect, Disconnect, Restart

Submit

The **System Log** page is located under **Misc. Network Settings** in the **System Management** folder. This is where you select the type of events that will be logged by the NPort.

Group	Event
System	System Cold Start, System Warm Start
Network	DHCP, Get IP/Renew, Mail Fail, NTP Connect Fail, IP Conflict, Network Link Down
Config	Login Fail, IP Changed, Password Changed, Firmware Upgrade, SSL Certificate Import, Config Import, Config Export, Wireless Certificate Import, Serial Data Log Export
Op Mode	Connect, Disconnect, Restart

Auto Warning Settings

Event Settings

MOXA® Total Solution for Industrial Device Networking www.moxa.com

Model - NPort W2250A-W4-US IP - 192.168.128.254 MAC Address - 00:90:E8:11:45:A3
 Name - NPortW2250A-W4_77 Serial No. - TBBKB0000077 Firmware - 0.1 Build 22071215
 Location -

System Event Settings

System Event	Mail	Trap
Cold start	<input type="checkbox"/>	<input type="checkbox"/>
Warm start	<input type="checkbox"/>	<input type="checkbox"/>
Config Event		
Console(web/text) login authentication fail	<input type="checkbox"/>	<input type="checkbox"/>
IP changed	<input type="checkbox"/>	
Password changed	<input type="checkbox"/>	

Submit

The **Event Settings** page is located under **Auto Warning Settings** in the **System Management** folder. This is where you specify how the NPort will notify you of system and configuration events. Depending on the event, different options for notification are available, as shown above. **Mail** refers to sending an e-mail to a specified address. **Trap** refers to sending an SNMP trap.

Event	Description
Cold start	The NPort was powered on or was restarted after a firmware upgrade.
Warm start	The NPort restarted without powering off.
Console login auth fail	An attempt has been made to open the web, Telnet, or serial console, but the password was incorrect.
IP changed	The IP address has been changed.
Password changed	The password to the console has been changed.

Serial Event Settings

The screenshot shows the MOXA web interface. At the top, there is a header with the MOXA logo, the slogan 'Total Solution for Industrial Device Networking', and the website 'www.moxa.com'. Below the header is a status bar with system information: Model (NPort W2250A-W4-US), Name (NPortW2250A-W4_77), Location (-), IP (192.168.128.254), Serial No. (TBBKB0000077), MAC Address (00:90:E8:11:45:A3), and Firmware (0.1 Build 22071215). The main content area is titled 'Serial Event Settings'. It contains a table with the following structure:

Serial Port Event	DCD changed		DSR changed	
Port 1	Mail <input type="checkbox"/>	Trap <input type="checkbox"/>	Mail <input type="checkbox"/>	Trap <input type="checkbox"/>
Port 2	Mail <input type="checkbox"/>	Trap <input type="checkbox"/>	Mail <input type="checkbox"/>	Trap <input type="checkbox"/>
All Ports	Mail <input type="checkbox"/>	Trap <input type="checkbox"/>	Mail <input type="checkbox"/>	Trap <input type="checkbox"/>

Below the table is a 'Submit' button. On the left side, there is a navigation menu with the following items: Overview, Wizard, Basic Settings, Network Settings, Serial Port Settings, System Management, Misc. Network Settings, Auto Warning Settings, Event Settings, and Serial Event Settings (circled in red).

The **Serial Event Settings** page is located under **Auto Warning Settings** in the **System Management** folder. This is where you specify how the NPort will notify you of DCD and DSR events for each serial port. **Mail** refers to sending an e-mail to a specified address. **Trap** refers to sending an SNMP trap.

A change in the DCD (Data Carrier Detect) signal shows that the modem connection status has changed. If the DCD signal changes to low, it shows that the connection line is down. A change in the DSR (Data Set Ready) signal shows that the data communication equipment is powered off. If the DSR signal changes to low, it shows that the data communication equipment is powered down.



ATTENTION

SNMP shows a change in DCD or DSR signals, but does not differentiate between the two. A change in either signal from “-” to “+” is showed by “link up” and a change in either signal from “+” to “-” is showed by “link down.”

E-mail Alert

The screenshot shows the MOXA web interface. At the top, there is a header with the MOXA logo, the slogan 'Total Solution for Industrial Device Networking', and the website 'www.moxa.com'. Below the header is a status bar with system information: Model (NPort W2250A-W4-US), Name (NPortW2250A-W4_77), Location (-), IP (192.168.128.254), Serial No. (TBBKB0000077), MAC Address (00:90:E8:11:45:A3), and Firmware (0.1 Build 22071215). The main content area is titled 'E-Mail Alert'. It contains a 'Mail settings' section with the following fields:

- Mail server (SMTP): [Text input field]
- My server requires authentication
- Username: [Text input field]
- Password: [Text input field]
- From e-mail address: [Text input field]
- To e-mail address 1: [Text input field]
- To e-mail address 2: [Text input field]
- To e-mail address 3: [Text input field]
- To e-mail address 4: [Text input field]

Below the fields is a 'Submit' button. On the left side, there is a navigation menu with the following items: Overview, Wizard, Basic Settings, Network Settings, Serial Port Settings, System Management, Misc. Network Settings, Auto Warning Settings, Event Settings, Serial Event Settings, E-mail Alert (circled in red), and Maintenance.

The **E-mail Alert** page is located under **Auto Warning Settings** in the **System Management** folder. This is where you specify how and where e-mail is sent when e-mail is used for automatic notification of system and serial port events.



ATTENTION

Consult your network administrator or ISP for the mail server settings to use for your network. If these settings are not configured correctly, e-mail notification may not work properly.

Mail Server (SMTP)

Default	
Options	Free text (e.g., "192.168.3.3")
Description	This field specifies the IP address of the mail server that will be used when sending automatic warning e-mails. If the mail server requires authentication, select My server requires authentication and enter the username and password.

From E-mail Address

Default	
Options	Free text (e.g., "jsmith@xyz.com")
Description	This field specifies the e-mail address that will be listed in the e-mail's From field.

To E-mail Address 1 to 4

Default	
Options	Free text (e.g., "admin@abc.com")
Description	These fields specify the destination e-mail address(es) for the automatic e-mail warnings.

SNMP Trap

The **SNMP Trap** page is located under **Auto Warning Settings** in the **System Management** folder. This is where you specify the SNMP trap settings to use for automatic notification of system and serial port events.

SNMP Trap Server IP

Default	
Options	IP address (e.g., "192.168.5.5")
Description	This field specifies the IP address of the SNMP trap server that will receive SNMP traps.

Trap Version

Default	v1
Options	v1, v2c
Description	This field specifies the SNMP trap version to use.

Trap Community

Default	
Options	Free text (e.g., "public access")
Description	This field specifies the SNMP trap community.

Maintenance

Console Settings

Configurations	
HTTP console	Enable ▾
HTTPS console (support TLS v1.2)	Enable ▾
TLS v1.0/v1.1 for HTTPS console	Disable ▾
Use strong ciphers on HTTPS/SSH console	Enable ▾
SSH console	Enable ▾
Telnet console	Enable ▾
Serial console	Enable ▾
Reset button	Always enable ▾

The **Console Settings** page is located under **Maintenance** in the **System Management** folder. This is where you enable or disable access to the various NPort configuration consoles, as well as the behavior of the reset button. You may change **HTTP console**, **HTTPS console (support TLS v1.2)**, **TLS v1.0/v1.1 for HTTPS console**, **Use strong ciphers on HTTPS/SSH console**, **SSH console**, **Telnet console**, **Serial console**, and **Reset button**.

HTTP Console

Default	Enable
Options	Enable, Disable
Description	This field enables or disables access to the HTTP (web) console.

HTTPS Console (supports TLS v1.2)

Default	Enable
Options	Enable, Disable
Description	This field enables or disables access to the HTTPS (web) console.

TLS v1.0/v1.1 for HTTPS Console (For Firmware V1.4 and later versions)

Default	Disable
Options	Enable, Disable
Description	This setting is to enable the TLS v1.0/v1.1 version with an HTTPS connection for backward compatibility with an outdated browser. We don't recommend enabling it.

Using Strong Ciphers on HTTPS/SSH Console (For Firmware V1.4 and later versions)

Default	Enable
Options	Enable, Disable
Description	When this feature is enabled, insecure ciphers, including SHA1 and MD5, will be removed.

SSH Console

Default	Enable
Options	Enable, Disable
Description	This field enables or disables access to the SSH console.

Telnet Console

Default	Enable
Options	Enable, Disable
Description	This field enables or disables access to the Telnet console.

Serial Console

Default	Enable
Options	Enable, Disable
Description	This field enables or disables access to the serial console.

Reset Button

Default	Always Enable
Options	Always Enable, Disable after 60 sec.
Description	This field specifies the behavior of the hardware reset button. Always Enable: The reset button will operate as usual. Disable after 60 sec: The reset button will only be effective for the first 60 seconds that the NPort is powered on.

Ping



The **Ping** page is located under **Maintenance** in the **System Management** folder. It provides a convenient way to test an Ethernet connection or verify an IP address. Enter the IP address or domain name in the Destination field and click **[Activate]**. The results will be displayed immediately.

Firmware Upgrade

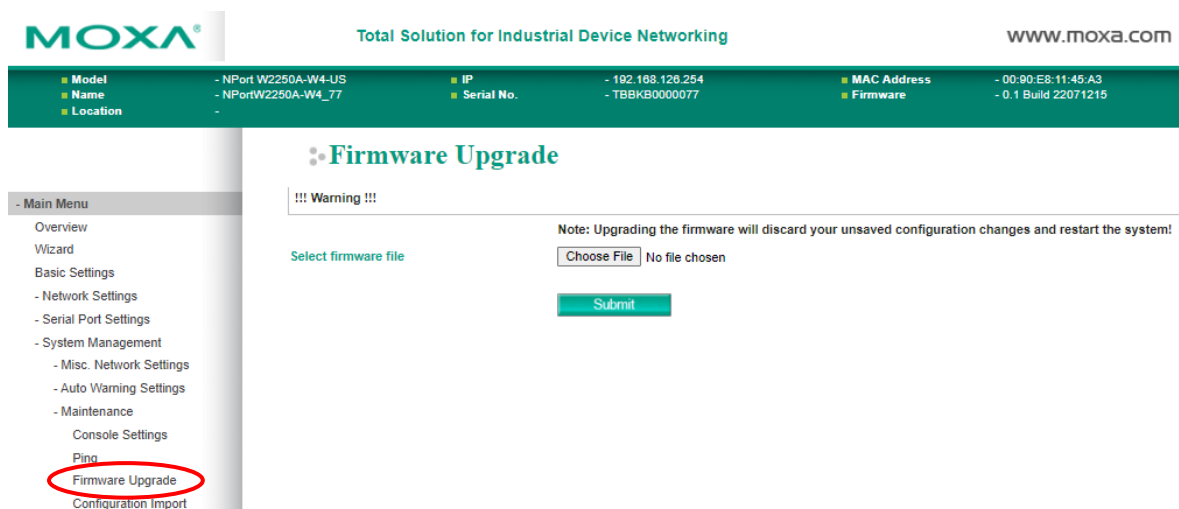

The **Firmware Upgrade** page is located under **Maintenance** in the **System Management** folder. This is where you can update the NPort firmware. After obtaining the latest firmware from www.moxa.com, select or browse for the firmware file in the **Select firmware file** field. Before clicking **[Submit]**, save the NPort configuration using the **Configuration Export** page, since the firmware upgrade process may cause all settings to revert to factory defaults.

Configuration Import

The screenshot shows the Moxa web interface. At the top, there is a header with the Moxa logo, the tagline 'Total Solution for Industrial Device Networking', and the website 'www.moxa.com'. Below the header is a status bar with system information: Model (NPort W2250A-W4-US), Name (NPortW2250A-W4_77), Location, IP (192.168.128.254), Serial No. (TBBKB9000077), MAC Address (00:90:E8:11:45:A3), and Firmware (0.1 Build 22071215). The main content area is titled 'Configuration Import' and contains a 'Select configuration file' field with a 'Choose File' button and a 'Submit' button. A checkbox labeled 'Import all configurations, including IP configurations' is also present. On the left, a sidebar menu lists various settings, with 'Configuration Import' circled in red.

The **Configuration Import** page is located under **Maintenance** in the **System Management** folder. This is where you can load a previously saved or exported configuration. Select or browse for the configuration file in the **Select configuration file** field. If you also wish to import the IP configuration (i.e., IP address, netmask, and gateway), make sure that **Import all configurations including IP configurations** is checked.



ATTENTION

You may import the existing configuration file of the NPort W2x50A Series to facilitate the process. Please note:

1. If your NPort W2x50A Series is configured as BOOTP of the IP configuration (Web console: under **Network Settings > Ethernet/Bridge Settings**), it will be DHCP instead.
2. If your NPort W2x50A Series is configured as Ad-hoc Mode of the Network type (Web console: under **Network Settings > WLAN Settings > Profile**), it will be Infrastructure Mode.
3. If your NPort W2x50A Series is configured less than 300 baudrate (Web console: **Serial Port Settings > Communication Parameters**), it will be 300.



NOTE

The NPort W2x50A-W4 Series configuration file cannot be imported to the NPort W2x50A Series for use.

Configuration Export



MOXA® Total Solution for Industrial Device Networking www.moxa.com

■ Model	- NPort W2250A-W4-US	■ IP	- 192.168.128.254	■ MAC Address	- 00:90:E8:11:45:A3
■ Name	- NPortW2250A-W4_77	■ Serial No.	- TBBKB0000077	■ Firmware	- 0.1 Build 22071215
■ Location	-				

- Main Menu

- Overview
- Wizard
- Basic Settings
- Network Settings
- Serial Port Settings
- System Management
 - Misc. Network Settings
 - Auto Warning Settings
 - Maintenance
 - Console Settings
 - Ping
 - Firmware Upgrade
 - Configuration Import
 - Configuration Export**
 - Load Factory Default

Configuration Export

Export

The **Configuration Export** page is located under **Maintenance** in the **System Management** folder. This is where you can save the NPort's current configuration to a file on the local host. Click **[Download]** to begin the process. A window should appear asking you to open or save the configuration text file.

Load Factory Default



MOXA® Total Solution for Industrial Device Networking www.moxa.com

■ Model	- NPort W2250A-W4-US	■ IP	- 192.168.128.254	■ MAC Address	- 00:90:E8:11:45:A3
■ Name	- NPortW2250A-W4_77	■ Serial No.	- TBBKB0000077	■ Firmware	- 0.1 Build 22071215
■ Location	-				

- Main Menu

- Overview
- Wizard
- Basic Settings
- Network Settings
- Serial Port Settings
- System Management
 - Misc. Network Settings
 - Auto Warning Settings
 - Maintenance
 - Console Settings
 - Ping
 - Firmware Upgrade
 - Configuration Import
 - Configuration Export
 - Load Factory Default**

Load Factory Default

Click on **Submit** to reset all the settings, including the console password, to the factory default values. To leave the IP address, netmask, gateway and WLAN profile settings unchanged, make sure that **Keep IP Settings** is enabled.

Reset to Factory Default

Keep IP settings

Submit

The **Load Factory Default** page is located under **Maintenance** in the **System Management** folder. Click **[Submit]** to reset all settings to the factory defaults. You can preserve the NPort's existing IP settings (i.e., IP address, netmask, gateway, WLAN profile, and all certificates) by making sure **Keep IP settings** is checked before clicking **[Submit]**.

Change Password

The **Change Password** page is located under **Maintenance** in the **System Management** folder. To change the password, choose the account name first, and then enter the old password in the **Old password** field. Enter the new password twice, once in the **New password** field and once in the **Confirm password**. Leave these fields blank to remove password protection.



ATTENTION

If you forget the password, the **ONLY** way to configure the NPort is by loading the factory defaults with the reset button. All settings will be lost.

Before setting the password, you may want to first export the configuration to a file. Your configuration can then be easily imported back into the NPort if necessary.

Certificate

Ethernet SSL Certificate Import

The **Ethernet SSL Certificate Import** page is located under **Certificate** in the **System Management** folder. This is where you can load the Ethernet SSL certificate. Select or browse for the certificate file in the **Select SSL certificate/key file** field. The NPort only supports the PEM format of the certificate so far. If your file is in another format, for example DER or PFX, please convert it to PEM first.

WLAN SSL Certificate Import

MOXA® Total Solution for Industrial Device Networking www.moxa.com

Model - NPort W2250A-W4-US IP - 192.168.128.254 MAC Address - 00:90:E8:11:45:A3
Name - NPortW2250A-W4_77 Serial No. - TBBKB0000077 Firmware - 0.1 Build 22071215
Location -

- Main Menu
Overview
Wizard
Basic Settings
- Network Settings
- Serial Port Settings
- System Management
- Misc. Network Settings
- Auto Warning Settings
- Maintenance
- Certificate
Ethernet SSL Certificate Import
WLAN SSL Certificate Import
WPA Server Certificate Import

WLAN SSL Certificate Import

Installed Certificate

Issued to: Not installed
Issued by: Not installed
Valid: from Not installed to Not installed

Select SSL certificate/key file: No file chosen

The **WLAN SSL Certificate Import** page is located under **Certificate** in the **System Management** folder. By default, the WLAN SSL certificate is automatically generated by the NPort based on the IP address of the wireless interface. You can also import a certificate. Select or browse for the certificate file in the **Select SSL certificate/key file** field.

WPA Server Certificate Import

MOXA® Total Solution for Industrial Device Networking www.moxa.com

Model - NPort W2250A-W4-US IP - 192.168.128.254 MAC Address - 00:90:E8:11:45:A3
Name - NPortW2250A-W4_77 Serial No. - TBBKB0000077 Firmware - 0.1 Build 22071215
Location -

- Main Menu
Overview
Wizard
Basic Settings
- Network Settings
- Serial Port Settings
- System Management
- Misc. Network Settings
- Auto Warning Settings
- Maintenance
- Certificate
Ethernet SSL Certificate Import
WLAN SSL Certificate Import
WPA Server Certificate Import
WPA User Certificate Import

WPA Server Certificate Import

Installed Certificate

Issued to: Not installed
Issued by: Not installed
Valid: from Not installed to Not installed

Select WPA server certificate file: No file chosen

The **WPA Server Certificate Import** page is located under **Certificate** in the **System Management** folder. This is where you can load the WPA server certificate. Select or browse for the certificate file in the **Select WPA server certificate file** field.

You must install the trusted server certificate from the RADIUS server in order to enable **Verify server certificate** in the WLAN **Security** settings. This certificate will then be used by the NPort to authenticate the RADIUS server.

WPA User Certificate Import

The screenshot shows the MOXA web interface. At the top, there is a header with the MOXA logo, the text 'Total Solution for Industrial Device Networking', and the website 'www.moxa.com'. Below the header is a status bar with device information: Model (NPort W2250A-W4-US), Name (NPortW2250A-W4_77), Location, IP (192.168.128.254), Serial No. (TBBKB0000077), MAC Address (00:90:E8:11:45:A3), and Firmware (0.1 Build 22071215). On the left is a main menu with categories like Overview, Wizard, Basic Settings, Network Settings, Serial Port Settings, System Management, and Certificate. Under Certificate, 'WPA User Certificate Import' is circled in red. The main content area is titled 'WPA User Certificate Import' and contains a form with the following fields: 'Issued to' (Not installed), 'Issued by' (Not installed), 'Valid' (from Not installed to Not installed), and 'Select WPA user certificate file' (Choose File, No file chosen). A 'Submit' button is located below the form.

The **WPA User Certificate Import** page is located under **Certificate** in the **System Management** folder. This is where you can load the WPA user certificate. Select or browse for the certificate file in the **Select WPA user certificate file** field.

The user certificate of the NPort must be installed in the RADIUS server when the NPort uses WPA (WPA2)/TLS. The trusted server certificate of the RADIUS server must also be installed in the NPort.

WPA User Key Import

The screenshot shows the MOXA web interface. At the top, there is a header with the MOXA logo, the text 'Total Solution for Industrial Device Networking', and the website 'www.moxa.com'. Below the header is a status bar with device information: Model (NPort W2250A-W4-US), Name (NPortW2250A-W4_77), Location, IP (192.168.128.254), Serial No. (TBBKB0000077), MAC Address (00:90:E8:11:45:A3), and Firmware (0.1 Build 22071215). On the left is a main menu with categories like Overview, Wizard, Basic Settings, Network Settings, Serial Port Settings, System Management, and Certificate. Under Certificate, 'WPA User Key Import' is circled in red. The main content area is titled 'WPA User Key Import' and contains a form with the following fields: 'Key length' (Not install!!), 'Select SSL certificate/key file' (Choose File, No file chosen), and 'Password for private key' (text input field). A 'Submit' button is located below the form.

The **WPA User Key Import** page is located under **Certificate** in the **System Management** folder. This is where you can load the WPA user certificate. Select or browse for the user's private key file in the **Select WPA user privacy key file** field and enter the **Password for the private key**.

The user private key of the NPort must be installed on the RADIUS server when the NPort uses WPA(WPA2)/TLS. The trusted server certificate of RADIUS server must also be installed on the NPort.

Certificate/Key Delete

The screenshot shows the Moxa web interface. At the top, the Moxa logo and tagline 'Total Solution for Industrial Device Networking' are visible, along with the website URL 'www.moxa.com'. Below this is a status bar with device information: Model (NPort W2250A-W4-US), Name (NPortW2250A-W4_77), Location, IP (192.168.128.254), Serial No. (TBBKB0000077), MAC Address (00:90:E8:11:45:A3), and Firmware (0.1 Build 22071215).

The main content area is titled 'Certificate/Key Deletion'. It features a section for 'Installed Certificate' with a table:

Installed Certificate	Delete	Keep
SSL certificate	<input type="radio"/>	<input checked="" type="radio"/>
WPA server certificate	No certificate installed!	
WPA user certificate/private key	No certificate/private key installed!	

Below the table is a 'Submit' button. The left sidebar contains a 'Main Menu' with various options, and 'Certificate/Key Deletion' is highlighted with a red circle.

The **Certificate/Key Delete** page is located under **Certificate** in the **System Management** folder. This page is where you can delete certificates or WPA keys that have been installed on the model. When you click **[Submit]**, any certificate or key that has been set to **Delete** will be deleted from the NPort.

10. Web Console: System Monitoring

Overview

This chapter explains how to use the **System Monitoring** functions on the NPort web console. These functions allow you to monitor many aspects of your operation.

System Monitoring

Serial Status

Serial to Network Connections

The screenshot shows the MOXA web console interface. At the top, there is a green header with the MOXA logo, the text "Total Solution for Industrial Device Networking", and the website "www.moxa.com". Below the header, there is a status bar with the following information:

Model	- NPort W2250A-W4-US	IP	- 192.168.126.254	MAC Address	- 00:90:E8:11:45:A3
Name	- NPortW2250A-W4_77	Serial No.	- TBBKB0000077	Firmware	- 0.1 Build 22071215
Location	-				

On the left side, there is a navigation menu with the following items:

- Main Menu
- Overview
- Wizard
- Basic Settings
- Network Settings
- Serial Port Settings
- System Management
 - Misc. Network Settings
 - Auto Warning Settings
 - Maintenance
 - Certificate
- System Monitoring
 - Serial Status
 - Serial-to-Network Connections**
 - Serial Port Status

The main content area is titled "Serial-to-Network Connections" and has an "Auto refresh" checkbox checked. Below this is a table with the following structure:

Port	OP Mode	Connections					
1	Real COM	[]	[]	[]	[]	[]	[]
2	Real COM	[]	[]	[]	[]	[]	[]

The **Serial to Network Connections** page is located under **Serial Status** in the **System Monitoring** folder. On this page, you can monitor the current operation mode and host connection status for each serial port.

Serial Port Status

MOXA® Total Solution for Industrial Device Networking www.moxa.com

Model - NPort W2250A-W4-US IP - 192.168.126.254 MAC Address - 00:90:E8:11:45:A3
 Name - NPortW2250A-W4_77 Serial No. - TBBKB0000077 Firmware - 0.1 Build 22071215
 Location -

- Main Menu
 Overview
 Wizard
 Basic Settings
 - Network Settings
 - Serial Port Settings
 - System Management
 - Misc. Network Settings
 - Auto Warning Settings
 - Maintenance
 - Certificate
 - System Monitoring
 - Serial Status
 Serial-to-Network Connections
Serial Port Status
 Serial Port Error Count

Serial Port Status

Auto refresh

Port	TxCnt	RxCnt	TxTotalCnt	RxTotalCnt	DSR	DTR	RTS	CTS	DCD
1	0	0	0	0	<input type="checkbox"/>	<input checked="" type="checkbox"/>	<input checked="" type="checkbox"/>	<input type="checkbox"/>	<input type="checkbox"/>
2	0	0	0	0	<input type="checkbox"/>	<input checked="" type="checkbox"/>	<input checked="" type="checkbox"/>	<input type="checkbox"/>	<input type="checkbox"/>

The **Serial Port Status** page is located under **Serial Status** in the **System Monitoring** folder. On this page, you can monitor the signal and data transmission status for each serial port.

TxCnt: number of Tx packets (to device) for the current connection

RxCnt: number of Rx packets (from device) for the current connection

TxTotalCnt: number of Tx packets since the NPort was powered on

RxTotalCnt: number of Rx packets since the NPort was powered on

Serial Port Error Count

MOXA® Total Solution for Industrial Device Networking www.moxa.com

Model - NPort W2250A-W4-US IP - 192.168.126.254 MAC Address - 00:90:E8:11:45:A3
 Name - NPortW2250A-W4_77 Serial No. - TBBKB0000077 Firmware - 0.3 Build 22071514
 Location -

- Main Menu
 Overview
 Wizard
 Basic Settings
 - Network Settings
 - Serial Port Settings
 - System Management
 - System Monitoring
 - Serial Status
 Serial-to-Network Connections
 Serial Port Status
Serial Port Error Count
 Serial Port Settings

Serial Port Error Count

Auto refresh

Port	ErrCnt			
	Frame	Parity	Overrun	Break
1	0	0	0	0
2	0	0	0	0

The **Serial Port Error Count** page is located under **Serial Status** in the **System Monitoring** folder. On this page, you can view the current number of frame, parity, overrun, and break errors for each serial port.

Serial Port Settings

Port	Baud Rate	Data Bits	Stop Bits	Parity	Flow Control		FIFO	Interface
					RTS/CTS	XON/XOFF		
1	115200	7	2	None	OFF	ON	Enable	RS-232
2	115200	7	2	None	OFF	ON	Enable	RS-232

The **Serial Port Settings** page is located under **Serial Status** in the **System Monitoring** folder. On this page, you can view the current communication settings for each serial port.

System Status

Network Connections

Protocol	Recv-Q	Send-Q	Local Address	Foreign Address	State
TCP	0	0	*:443	*:0	LISTEN
TCP	0	0	*:4900	*:0	LISTEN
TCP	0	0	*:966	*:0	LISTEN
TCP	0	0	*:967	*:0	LISTEN
TCP	0	0	*:80	*:0	LISTEN
TCP	0	0	*:950	*:0	LISTEN
TCP	0	0	*:22	*:0	LISTEN
TCP	0	0	*:951	*:0	LISTEN
TCP	0	0	*:23	*:0	LISTEN
TCP	0	1391	192.168.126.254:80	169.254.164.100:60563	ESTABLISHED
UDP	0	0	*:161	*:0	
UDP	0	0	*:4800	*:0	

The **Network Connections** page is located under **System Status** in the **System Monitoring** folder. On this page, you can view the status of any network connection to the NPort.

Serial Data Log

Data logs for each serial port can be viewed in ASCII or HEX format. After selecting the serial port and format, you may click **Select** all to select the entire log if you wish to copy and paste the contents into a text file. The **Clear log** and **Refresh** buttons allow you to clear or refresh the log contents.

The screenshot shows the MOXA web interface for an NPort device. At the top, the MOXA logo and 'Total Solution for Industrial Device Networking' are displayed, along with the website URL 'www.moxa.com'. Below this is a status bar with device information: Model (NPort W2250A-W4-US), Name (NPortW2250A-W4_77), Location (-), IP (192.168.126.254), Serial No. (TBBKB0000077), MAC Address (00:90:E8:11:45:A3), and Firmware (0.1 Build 22071215). The main content area is titled 'Serial Data Log' and contains a 'Download Serial Data Log' section. This section includes a 'Serial port' dropdown menu currently set to 'Port1', a 'Download format' section with radio buttons for 'ASCII' (selected) and 'HEX', and two buttons: 'Clear log' and 'Download'. On the left side, there is a sidebar menu with various navigation options. The 'Serial Data Log' option is circled in red.

The **Serial Data Log** page is located under **System Status** in the **System Monitoring** folder. This is where you can download the current data log for a serial port. Select the desired serial port in the **Select port** field. Select the desired data format in the **Download format** field. Click **[Clear log]** to clear the log contents.

The data log includes all data sent or received by the specified serial port since the NPort was powered on. The maximum size of the log is 64 KB.

System Log

The screenshot shows the MOXA web interface for an NPort device. At the top, the MOXA logo and 'Total Solution for Industrial Device Networking' are displayed, along with the website URL 'www.moxa.com'. Below this is a status bar with device information: Model (NPort W2250A-W4-US), Name (NPortW2250A-W4_77), Location (-), IP (192.168.126.254), Serial No. (TBBKB0000077), MAC Address (00:90:E8:11:45:A3), and Firmware (0.1 Build 22071215). The main content area is titled 'System Log' and contains a 'System Log' section. This section includes a large empty box for the log content and two buttons: 'Clear log' and 'Refresh'. On the left side, there is a sidebar menu with various navigation options. The 'System Log' option is circled in red.

The **System Log** page is located under **System Status** in the **System Monitoring** folder. This is where you can view the log of NPort system events. Click **[Clear log]** to clear the log contents. Click **[Refresh]** to refresh the log contents.

WLAN Log

MOXA Total Solution for Industrial Device Networking www.moxa.com

■ Model - NPort W2250A-W4 ■ IP - 10.0.2.59 ■ MAC Address - 14:13:33:4B:6A:07
■ Name - NPortW2250A-W4_323 ■ Serial No. - TMOXA0000323 ■ Firmware - 0.3 Build 22071510
■ Location -

- Main Menu

- Overview
- Wizard
- Basic Settings
 - Network Settings
 - Serial Port Settings
 - System Management
 - System Monitoring
 - Serial Status
 - System Status
 - Network Connections
 - Serial Data Log
 - System Log
 - WLAN Log**
 - WLAN Status
- Restart

WLAN Log

```
2022/07/20 02:49:52 Scan 28 APs, show the best 3 with the same SSID:
2022/07/20 02:49:52 01. 06:90:e8:53:ff:c3 ssid='MOXA_RoamingTest'
2022/07/20 02:49:52 freq=2412 rssi=-91 dBm
2022/07/20 02:49:52 Skip roam
2022/07/20 02:49:55 Scan 29 APs, show the best 3 with the same SSID:
2022/07/20 02:49:55 01. 06:90:e8:53:d9:cf ssid='MOXA_RoamingTest'
2022/07/20 02:49:55 freq=2437 rssi=-65 dBm
2022/07/20 02:49:55 02. 06:90:e8:53:ff:c3 ssid='MOXA_RoamingTest'
2022/07/20 02:49:55 freq=2412 rssi=-92 dBm
2022/07/20 02:49:55 Need to roam
2022/07/20 02:49:55 Connect to 06:90:e8:53:d9:cf on channel 6
2022/07/20 02:49:55 Authentication completed
2022/07/20 02:49:55 Disconnect from 06:90:e8:53:d9:cf, reason=3
2022/07/20 02:49:57 WLAN start
2022/07/20 02:49:57 Be located in strong interference environment.
```

Clear log Download Refresh

The **WLAN Log** page is located under **System Status** in the **System Monitoring** folder. This is where you can view the log between the device server and the access points. It's an excellent tool for an engineer to troubleshoot if there is any issue with the wireless connection. To clear the log contents, click **[Clear log]**. Click **[Download]** to save the log to a txt file for an engineer to troubleshoot, e.g., Moxa's Technical Support Team. Click **[Refresh]** to refresh the log contents.



NOTE

The WLAN log is for R&D analysis. If you encounter a wireless problem, please provide the WLAN log and topology for MOXA diagnostic purposes.

WLAN Status

MOXA Total Solution for Industrial Device Networking www.moxa.com

■ Model - NPort W2250A-W4-US ■ IP - 192.168.128.254 ■ MAC Address - 00:90:E8:11:45:A3
■ Name - NPortW2250A-W4_77 ■ Serial No. - TBBKB0000077 ■ Firmware - 0.1 Build 22071215
■ Location -

- Main Menu

- Overview
- Wizard
- Basic Settings
 - Network Settings
 - Serial Port Settings
 - System Management
 - Misc. Network Settings
 - Auto Warning Settings
 - Maintenance
 - Certificate
 - System Monitoring
 - Serial Status
 - System Status
 - Network Connections
 - Serial Data Log
 - System Log
 - WLAN Log
 - WLAN Status**
 - Restart

WLAN Status

Auto refresh

Information

Active profile name	N/A
IP configuration	Static
IP address	N/A
Netmask	N/A
Gateway	N/A
Network type	N/A
RF type	N/A
SSID	N/A
Channel	N/A
Authentication	N/A
Encryption	N/A
Region	US
Signal strength	N/A
Connection speed	N/A
Current BSSID	N/A

The **WLAN Status** page is located under **System Status** in the **System Monitoring** folder. This is where you can view the current WLAN settings and status.

11. Web Console: Restart

Overview

This chapter explains how to save your configuration changes and restart the NPort using the NPort web console. Configuration changes will not be effective until they are saved, and the NPort is rebooted.

Restart

Restart System

The screenshot shows the MOXA web console interface. At the top, there is a header with the MOXA logo, the tagline "Total Solution for Industrial Device Networking", and the website "www.moxa.com". Below the header is a status bar with the following information:

Model	- NPort W2250A-W4-US	IP	- 192.168.126.254	MAC Address	- 00:90:E8:11:45:A3
Name	- NPortW2250A-W4_77	Serial No.	- TBBKB0000077	Firmware	- 0.1 Build 22071215
Location	-				

The main content area is titled "System Restart" and contains a warning message: "!!! Warning !!! Clicking Restart will disconnect all serial and Ethernet connections and reboot the system. NOTE: Unsaved configuration changes will be discarded, and data currently in the middle of transmission may be lost." Below the warning is a "Submit" button. The left sidebar menu has "Restart System" circled in red.

The **Restart System** page is in the **Restart** folder. Click **[Restart]** to restart the NPort, and the new settings will take effect upon restart.

Restart Ports

The screenshot shows the MOXA web console interface. At the top, there is a header with the MOXA logo, the tagline "Total Solution for Industrial Device Networking", and the website "www.moxa.com". Below the header is a status bar with the following information:

Model	- NPort W2250A-W4-US	IP	- 192.168.126.254	MAC Address	- 00:90:E8:11:45:A3
Name	- NPortW2250A-W4_77	Serial No.	- TBBKB0000077	Firmware	- 0.1 Build 22071215
Location	-				

The main content area is titled "Restart Ports" and contains a "Select Ports" section with checkboxes for "Port 1" and "Port 2". Below the checkboxes is a "Submit" button. The left sidebar menu has "Restart Ports" circled in red.

The **Restart Ports** page is in the **Restart** folder. Select the desired serial and click **[Select All]** to select all serial ports. Click **[Submit]** to restart the selected serial ports.

12. Android API Instructions

Overview

If you want to remote control your serial devices on an Android platform, then the MxNPortAPI is a simple application programming tool you can use. The MxNPortAPI helps programmers develop an Android application to access the device server by TCP/IP.

The MxNPortAPI provides frequently used serial command sets like port control, input/output, etc., and the style of developed Android application is similar to MOXA Driver Manager. For more details about the provided functions, please refer to the "MxNPortAPI Function Groups" section.

This MxNPortAPI is layered between the Android application and Android network manager framework. This Android library is compatible with Java 1.7, Android 3.1 (Honeycomb - API version 12), and later versions.

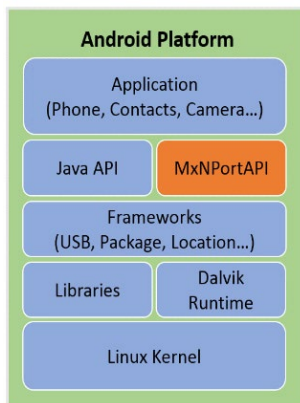

How to Start MxNPortAPI

You can download the MxNPortAPI from Moxa's website at <http://www.moxa.com>, and develop the application program in popular OSs, such as Windows, Linux, or Mac.

(You can refer the Android studio website to see the system requirements for the development environment: <https://developer.android.com/studio/index.html?hl=zh-tw#Requirements>).

To start your application program, please unzip the MxNPortAPI file and refer to the index (.html) under the Help directory.

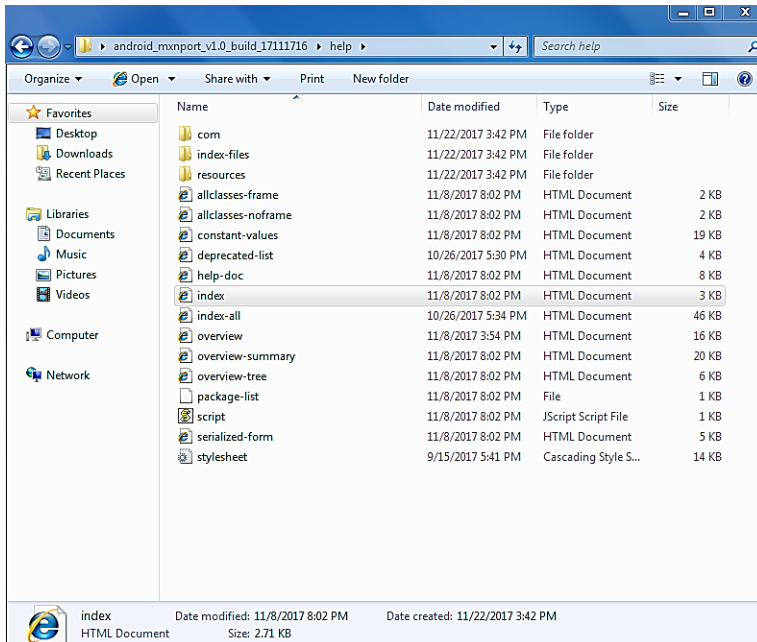

For more details about the installation, please refer to the Overview section.

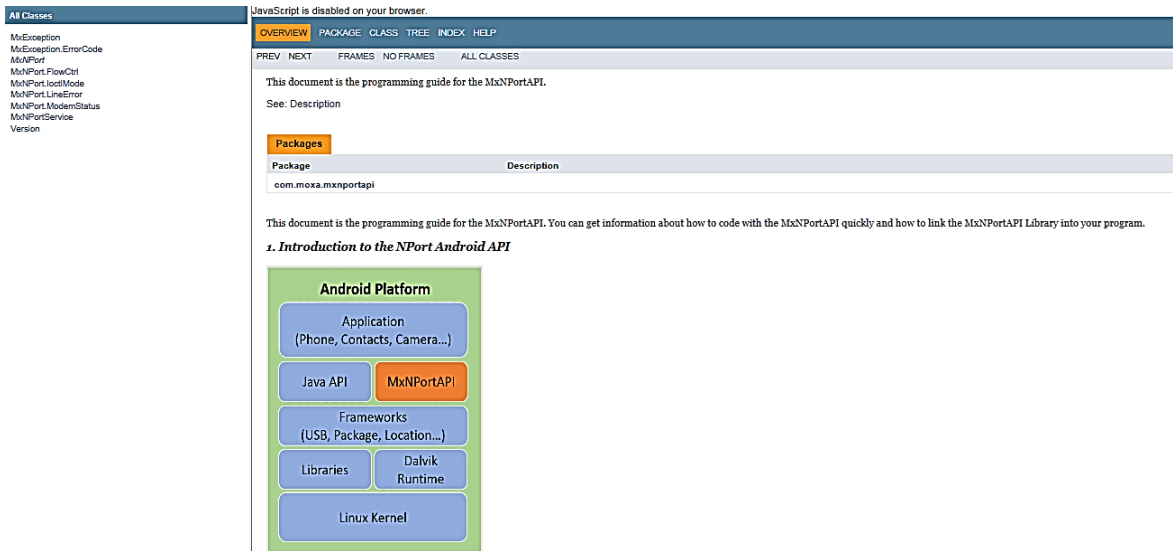

MxNPortAPI Function Groups

The supported functions in this API are listed below:

Port Control	Input/Output	Port Status Inquiry	Miscellaneous
open close setIoctlMode setFlowCtrl setBaud setRTS setDTR flush	read write	getBaud getFlowCtrl getIoctlMode getLineStatus getModemStatus getOQueue	setBreak

Example Program

To make sure this API is workable with the device server on an Android platform, see the example program below:

```

Thread thread = new Thread()
{
    @Override
    public void run() {
        /* Enumerate and initialize NPorts on system */
        List<MxNPort> NPortList = MxNPortService.getNPortInfoList();
        if(NPortList!=null){
            MxNPort.IoctlMode mode = new MxNPort.IoctlMode();
            mode.baudRate = 38400;
            mode.dataBits = MxNPort.DATA_BITS_8;
            mode.parity = MxNPort.PARITY_NONE;
            mode.stopBits = MxNPort.STOP_BITS_1;

            MxNPort mxNPort = NPortList.get(0); /* Get first NPort device */
            try {
                byte[] buf = {'H','e','l','l','o',' ','W','o','r','l','d'};
                mxNPort.open(); /*open port*/
                mxNPort.setIoctlMode(mode); /*serial parameters setting*/
                mxNPort.write(buf, buf.length); /*write data*/
                mxNPort.close(); /*close port*/
            } catch (MxException e){
                /*Error handling*/
            }
        }
    }
};
thread.start();

```

A. SNMP Agents with MIB II & RS-232-Like Groups

The NPort has built-in SNMP (Simple Network Management Protocol) agent software that supports SNMP Trap, RFC1317 RS-232 like groups and RFC 1213 MIB-II. The following table lists the standard MIB-II groups, as well as the variable implementation for the NPort.

RFC1213 MIB-II Supported SNMP Variables

System MIB

SysDescr	SysContact	SysServices
SysObjectID	SysName	
SysUpTime	SysLocation	

Interfaces MIB

ifNumber	ifOperStatus	ifOutOctets
ifIndex	ifLastChange	ifOutUcastPkts
ifDescr	ifInOctets	ifOutNUcastPkts
ifType	ifInUcastPkts	ifOutDiscards
ifMtu	ifInNUcastPkts	ifOutErrors
ifSpeed	ifInDiscards	ifOutQLen
ifPhysAddress	ifInErrors	ifSpecific
ifAdminStatus	ifInUnknownProtos	

IP MIB

ipForwarding	ipOutDiscards	ipAdEntIfIndex
ipDefaultTTL	ipOutNoRoutes	ipAdEntNetMask
ipInreceives	ipReasmTimeout	ipAdEntBcastAddr
ipInHdrErrors	ipReasmReqds	ipAdEntReasmMaxSize
ipInAddrErrors	ipReasmOKs	IpNetToMediaIfIndex
ipForwDatagrams	ipReasmFails	IpNetToMediaPhysAddress
ipInUnknownProtos	ipFragOKs	IpNetToMediaNetAddress
ipInDiscards	ipFragFails	IpNetToMediaType
ipInDelivers	ipFragCreates	IpRoutingDiscards
ipOutRequests	ipAdEntAddr	

ICMP MIB

IcmpInMsgs	IcmpInTimestamps	IcmpOutRedirects
IcmpInErrors	IcmpTimeSt ampReps	IcmpOutEchos
IcmpInDestUnreachs	IcmpInAddrMasks	IcmpOutEchoReps
IcmpInTimeExcds	IcmpOutMsgs	IcmpOutTimestamps
IcmpInParmProbs	IcmpOutErrors	IcmpOutTimestampReps
IcmpInSrcQuenchs	IcmpOutDestUnreachs	IcmpOutAddrMasks
IcmpInRedirects	IcmpOutTimeExcds	IcmpOutAddrMaskReps
IcmpInEchos	IcmpOutParmProbs	
IcmpInEchoReps	IcmpOutSrcQuenchs	

UDP MIB

UdpInDatagrams	UdpOutDatagrams
UdpNoPorts	UdpLocalAddress
UdpInErrors	UdpLocalPort

Address Translation

AtIfIndex	AtNetAddress
AtPhysAddress	

TCP MIB

tcpRtoAlgorithm	tcpEstabResets	tcpConnLocalPort
tcpRtoMin	tcpCurrEstab	tcpConnRemAddress
tcpRtoMax	tcpInSegs	tcpConnRemPort
tcpMaxConn	tcpOutSegs	tcpInErrs
tcpActiveOpens	tcpRetransSegs	tcpOutRsts
tcpPassiveOpens	tcpConnState	
tcpAttemptFails	tcpConnLocalAddress	

SNMP MIB

snmpInPkts	snmpInTotalReqVars	snmpOutGenErrs
snmpOutPkts	snmpInTotalSetVars	snmpOutGetRequests
snmpInBadVersions	snmpInGetRequests	snmpOutGetNexts
snmpInBadCommunityNames	snmpInGetNexts	snmpOutSetRequests
snmpInASNParseErrs	snmpInSetRequests	snmpOutGetResponses
snmpInTooBig	snmpInGetResponses	snmpOutTraps
snmpInNoSuchNames	snmpInTraps	snmpEnableAuthenTraps
snmpInBadValues	snmpOutTooBig	
snmpInReadOnly	snmpOutNoSuchNames	
snmpInGenErrs	snmpOutBadValues	

RFC1317: RS-232 MIB Objects

Generic RS-232-like Group

rs232Number

RS-232-like General Port Table

rs232PortTable
rs232PortEntry
rs232PortIndex
rs232PortType
rs232PortInSigNumber
rs232PortOutSigNumber
rs232PortInSpeed
rs232PortOutSpeed

RS-232-like Asynchronous Port Group

rs232AsyncPortTable
rs232AsyncPortEntry

rs232AsyncPortIndex
rs232AsyncPortBits

rs232AsyncPortStopBits
rs232AsyncPortParity

The Input Signal Table

rs232InSigTable
rs232InSigEntry

rs232InSigPortIndex
rs232InSigName

rs232InSigState

The Output Signal Table

rs232OutSigTable
rs232OutSigEntry

rs232OutSigPortIndex
rs232OutSigName

rs232OutSigState

B. Well-known Port Numbers

Listed below are Well-known Port Numbers that may cause network problems if they are assigned to an NPort serial port. Refer to RFC 1700 for Well-known Port Numbers or refer to the following introduction from IANA.

The port numbers are divided into three ranges: Well-known Ports, Registered Ports, and Dynamic and/or Private Ports.

- **Well-known Ports** range from 0 through 1023.
- **Registered Ports** range from 1024 through 49151.
- **Dynamic and/or Private Ports** range from 49152 through 65535.

The Well-known Ports are assigned by IANA, and on most systems, can only be used by system processes or by programs executed by privileged users. The following table shows famous port numbers among the well-known port numbers. For more details, please visit the IANA website at <http://www.iana.org/assignments/port-numbers>.

TCP Socket	Application Service
0	reserved
1	TCP Port Service Multiplexor
2	Management Utility
7	Echo
9	Discard
11	Active Users (sysstat)
13	Daytime
15	Netstat
20	FTP data port
21	FTP CONTROL port
23	Telnet
25	Simple Mail Transfer Protocol (SMTP)
37	Time (Time Server)
42	Host name server (names server)
43	Whois (nickname)
49	Login Host Protocol (Login)
53	Domain Name Server (domain)
79	Finger protocol (Finger)
80	World Wide Web HTTP
119	Network News Transfer Protocol (NNTP)
123	Network Time Protocol
213	IPX
160 to 223	Reserved for future use

UDP Socket	Application Service
0	reserved
2	Management Utility
7	Echo
9	Discard
11	Active Users (sysstat)
13	Daytime
35	Any private printer server
39	Resource Location Protocol
42	Host name server (names server)
43	Whois (nickname)
49	Login Host Protocol (Login)
53	Domain Name Server (domain)
69	Trivial Transfer Protocol (TFTP)
70	Gopher Protocol
79	Finger Protocol
80	World Wide Web HTTP
107	Remote Telnet Service
111	Sun Remote Procedure Call (Sunrpc)
119	Network News Transfer Protocol (NNTP)
123	Network Time Protocol (NTP)
161	(Simple Network Mail Protocol (SNMP)
162	SNMP Traps
213	IPX (Used for IP Tunneling)

C. Ethernet Modem Commands

A serial port on the NPort can be set to Ethernet Modem mode, allowing a PC or device to connect to the NPort as if it was an Ethernet modem. This section provides additional details about how the NPort operates in Ethernet Modem mode.

Dial-in Operation

The NPort can listen for a TCP/IP connection request from a remote Ethernet modem or host. The NPort's response depends on the ATSO value, as follows.

ATSO=0: The NPort will temporarily accept the TCP connection and then send the "RING" signal out through the serial port. The serial controller must reply with "ATA" within 2.5 seconds to accept the connection request, after which the NPort enters data mode. If no "ATA" command is received, the NPort will disconnect after sending three "RING" signals.

ATSO≥1: The NPort will accept the TCP connection immediately. It will send the "CONNECT {baudrate}" command to the serial port and will immediately enter data mode.

Dial-out

The NPort accepts ATD commands such as "ATD 192.168.1.1:4001" from the serial port. It will then request a TCP connection from the specified remote Ethernet modem or PC. Once the remote unit accepts this TCP connection, the NPort will send the "CONNECT {baudrate}" command to the serial port and will immediately enter data mode.

Disconnection Request from Local Site

When the NPort is in data mode, you can start disconnection by sending "+++". Some applications allow you to directly set the DTR signal to off, which will also start disconnection. The NPort will enter command mode, and you can then enter "ATH" to close the TCP connection "NO CARRIER" will be returned to the serial port.



ATTENTION

When entering "+++" to disconnect, the three "+" characters must be sent in quick succession, and the sequence must be prefaced and followed by a guard time to protect the raw data. You can change the disconnect character using register S2. You can set the guard time using register S12.

Disconnection Request from Remote Site

After the TCP connection has been closed by the remote Ethernet modem or PC, the NPort will send "NO CARRIER" to the serial port and will return to command mode.

AT Commands

Ethernet Modem mode supports the following common AT commands, as used with a typical modem:

No.	Command	Description	Remarks
1	ATA	Answer manually	
2	ATD	Dial up specified IP address and port number ATD 192.168.1.1:950 (example)	
3	ATE	ATE0=Echo OFF ATE1=Echo ON (default)	
4	ATH	ATH0=On-hook (default) ATH1=Off-hook	
5	ATI, ATIO, ATI1, ATI2	Modem version	reply "OK" only
6	ATL	Speaker volume option	reply "OK" only
7	ATM	Speaker control option	reply "OK" only
8	ATO	On line command	
9	ATP, ATT	Set Pulse/Tone Dialing mode	reply "OK" only
10	ATQ0, ATQ1	Quiet command (default=ATQ0)	
11	ATSr=n	Change the contents of S register	see "S registers"
12	ATSr?	Read the contents of S register	see "S registers"
13	ATV	Result code type ATV0 for digit code, ATV1 for text code (default) 0=OK 1=connect 2=ring 3=No carrier 4=error	
14	ATZ	Reset (disconnect, enter command mode and restore the flash settings)	
15	AT&C	Serial port DCD control AT&C0=DCD always on AT&C1=DTE detects connection by DCD on/off (default)	
16	AT&F	Restore manufacturer's settings	
17	AT&G	Select guard time	reply "OK" only
18	AT&R	Serial port RTS option command	reply "OK" only
19	AT&S	Serial port DSR control	reply "OK" only
20	AT&V	View settings	
21	AT&W	Write current settings to flash for next boot up	

S Registers

No.	Register	Description	Remarks
1	S0	Ring to auto-answer (default=0)	
2	S1	Ring counter (always=0)	no action applied
3	S2	Escape code character (default=43 ASCII "+")	
4	S3	Return character (default=13 ASCII)	
5	S4	Line feed character (default=10 ASCII)	
6	S5	Backspace character (default= 8 ASCII)	
7	S6	Wait time for dial tone (always=2, unit=sec)	no action applied
8	S7	Wait time for carrier (default=3, unit=sec)	
9	S8	Pause time for dial delay (always=2, unit=sec)	no action applied
10	S9	Carrier detect response time (always=6, unit 1/10 sec)	no action applied
11	S10	Delay for hang up after carrier (always=14, unit 1/10 sec)	no action applied
12	S11	DTMF duration and spacing (always=100 ms)	no action applied
13	S12	Escape code guard time (default=50, unit 1/50 sec) to control the idle time for "+++"	