

IMC-P21GA-G2 Series Quick Installation Guide

Moxa Industrial Media Converter

Version 1.1, August 2024

Technical Support Contact Information
www.moxa.com/support

MOXA[®]

© 2024 Moxa Inc. All rights reserved.

P/N: 1802000210132



Overview

The IMC-P21GA-G2 Series includes industrial 10/100/1000BaseT(X)-to-100/1000Base-FX media converters that offer a designed solution for a reliable and stable operation in industrial environments.

Package Checklist

The following items are included with the shipment of the IMC-P21GA-G2 Series:

- Moxa PoE+ Gigabit Ethernet-to-fiber media converters
- Quick installation guide (printed)
- Warranty card

NOTE If any of these items are missing or damaged, please contact your customer service representative for assistance.

Features

- Supports 10/100/1000BaseT(X) auto-negotiation and auto-MDI/MDI-X
- Supports Link Fault Pass-through (LFP)
- Multi-mode and single-mode with SC or ST fiber connector available
- Redundant VDC (44 to 57 VDC) power inputs, DIN rail or wall mountable (optional)
- Operating temperature ranges from -10 to 60°C
- Supports store-and-forward mode and pass-through mode

Panel Layout of the IMC-P21GA-G2 Series

Front Panel View (IMC-P21GA-G2-SX-SC)

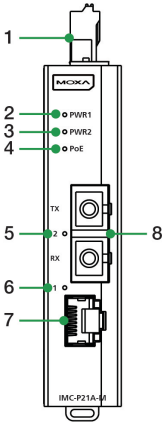

1. Terminal block for power input PWR1/PWR2
2. Power input PWR1 LED
3. Power input PWR2 LED
4. Smart PoE LED indicator of PoE+ port
5. Fiber Link
6. 10/100/1000Mbps copper port LED
7. 10/100/1000 Mbps IEEE 802.3af/at port
8. 1000Base-FX (ST/SC connector) or SFP Port
9. Grounding screw
10. DIP switch
11. DIN-rail mounting kit

Top Panel View

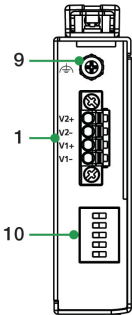

Rear Panel View



Mounting Dimensions (unit = mm)

Unit: mm

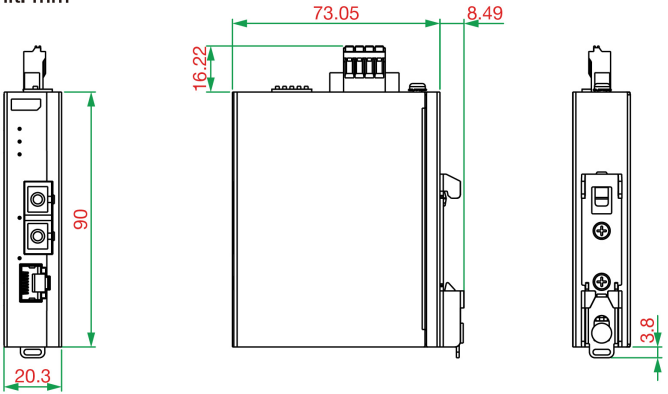

Front View

Side View

Rear View

DIN-rail Mounting

The metal DIN-rail mounting kit in the package is fixed to the back panel of the IMC-P21GA-G2 Series. Mount the IMC-P21GA-G2 Series on a corrosion-free mounting rail that adheres to the EN 60715 standard.

NOTE The length of the screws for DIN-rail mount bracket used: 6 mm; Ø 3 mm.

Suggested Installation Method

STEP 1: Insert the upper lip of the DIN-rail kit into the mounting rail.

STEP 2: Press the IMC-P21GA-G2 Series towards the mounting rail until it snaps into place.

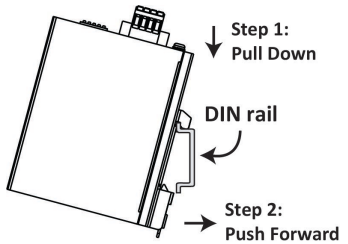

Suggested Removal Method

STEP 1: Pull down the latch on the DIN-rail kit with a screwdriver.

STEP 2: Gently pull the IMC-P21GA-G2 Series forward and lift it up to remove it from the mounting rail.

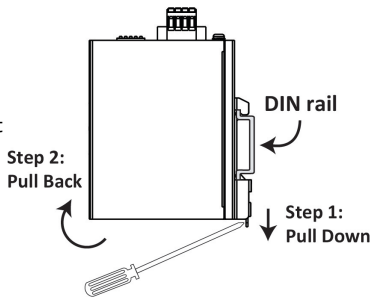

Wall Mounting (optional)

For some applications, it is convenient to mount the IMC-P21GA-G2 Series on the wall, as shown in the following illustrations.

NOTE The length of screws used for the wall-mount bracket:

- Equipment side: 6 mm; Ø 3 mm.
- Wall side: 10 mm; Ø 3 mm.

STEP 1: Remove the aluminum DIN-rail attachment plate from the rear panel of the IMC-P21GA-G2 Series, and then attach the wall-mount plates with three M3 screws.

STEP 2: Mounting the IMC-P21GA-G2 Series on the wall requires two M3 screws. Use the IMC-P21GA-G2 Series with the wall-mount plates attached as a guide to mark the correct location of the two screws.

Unit: mm (inch)

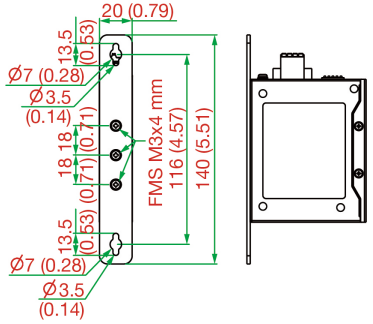

Grounding the IMC-P21GA-G2 Series

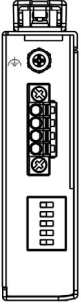

Grounding and wire routing help limit the effects of noise due to electromagnetic interference (EMI). Run the ground connection from the ground screw to the grounding surface before connecting the devices.

Wiring the Power Inputs

The 4-contact terminal block connector on the IMC-P21GA-G2's top panel is used for the IMC-P21GA-G2's two DC inputs. The top and front views of one of the terminal block connectors are shown here.

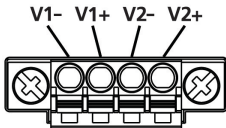

STEP 1: Use a small flat-blade screwdriver to press a wire locker.

STEP 2: Insert a positive/negative DC wire into the V+/V- terminals, respectively.

STEP 3: Release the wire locker and check whether the wire is fixed.

Install the input terminal block using 16 to 28 AWG wires with 8 to 9 mm of the conductor insulation stripped.

Redundant Power Inputs

Both power inputs can be connected simultaneously to live DC power sources. If one power source fails, the other live source acts as a backup, and automatically supplies all the IMC-P21GA-G2's power needs.

Communication Connections

RJ45 Ethernet Port Connection

The IMC-P21GA-G2 has one 10/100/1000BaseT(X) Ethernet port on the front panel to connect Ethernet-enabled devices.

When connected to a 10/100 Mbps Ethernet port, the pinouts and cable wiring diagrams for both the MDI (NIC-type) and MDI-X (HUB/switch type) ports for both straight-through and crossover Ethernet cables are:

MDI Port Pinouts

Pin	Signal
1	Tx+
2	Tx-
3	Rx+
6	Rx-

MDI-X Port Pinouts

Pin	Signal
1	Rx+
2	Rx-
3	Tx+
6	Tx-

8-pin RJ45

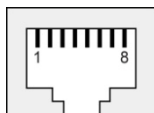

Straight-Through Cable Wiring

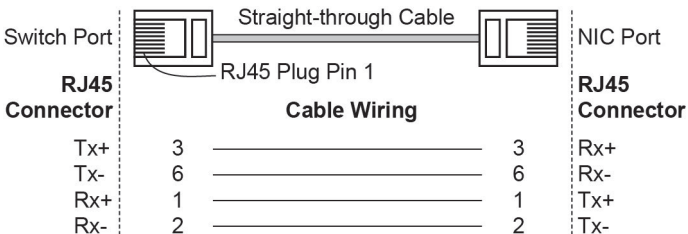

Crossover Cable Wiring

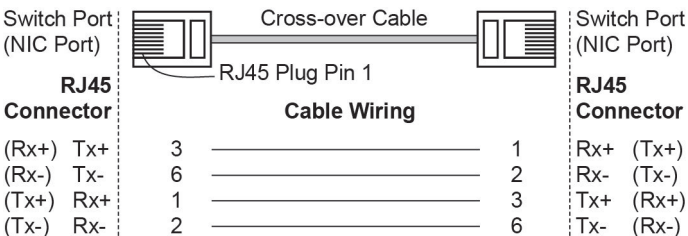

1000BaseT(X) Ethernet Port Connection

1000BaseT(X) data is transmitted on differential TRD+/- signal pairs over copper wires. When connected to a 1000 Mbps Ethernet port, the pinouts and cable wiring diagrams for both the MDI (NIC-type) and MDI-X (HUB/switch-type) ports for both straight-through and crossover Ethernet cables are:

MDI/MDI-X Port Pinouts

Pin	Signal
1	TRD (0) +
2	TRD (0) -
3	TRD (1) +
4	TRD (2) +
5	TRD (2) -
6	TRD (1) -
7	TRD (3) +
8	TRD (3) -

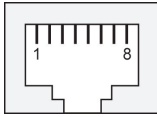

1000BaseSFP Fiber Port Connection

The Gigabit Ethernet ports on the IMC-P21GA-G2 Series are 1000BaseSFP Fiber ports, which require using Gigabit mini-GBIC fiber transceivers to work properly.

The concept behind the LC port and cable is straightforward. Suppose you are connecting devices I and II: Contrary to electrical signals, optical signals do not require a circuit to transmit data. One of the optical lines is used to transmit data from device I to device II, and the other optical line is used to transmit data from device II to device I, for full-duplex transmission.

Remember to connect the Tx (transmit) port of device I to the Rx (receive) port of device II, and the Rx (receive) port of device I to the Tx (transmit) port of device II. If you make your own cable, we suggest that you label the two sides of the same line with the same letter (A-to-A and B-to-B, as shown below, or A1-to-A2 and B1-to-B2).

LC-Port Pinouts

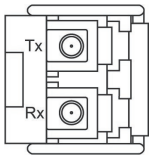

LC-Port to LC-Port Cable Wiring

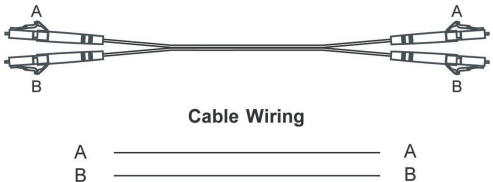

1000BaseSX/LX Fiber Port (IMC-P21GA-G2-SX-SC, IMC-P21GA-G2-LX-SC)

The concept behind the SC port and cable is straightforward. Suppose you are connecting devices I and II: Contrary to electrical signals, optical signals do not require a circuit to transmit data. One of the optical lines is used to transmit data from device I to device II, and the other optical line is used to transmit data from device II to device I, for full-duplex transmission.

All you need to remember is to connect the Tx (transmit) port of device I to the Rx (receive) port of device II, and the Rx (receive) port of device I to the Tx (transmit) port of device II. If you make your own cables, we suggest you label the two sides of the same line with the same letter (A-to-A and B-to-B, as shown below, or A1-to-A2 and B1-to-B2).

SC-Port Pinouts

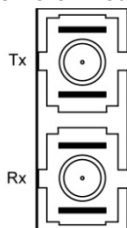

SC-Port to SC-Port Cable Wiring

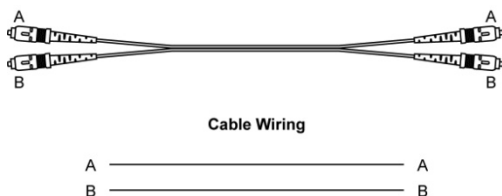

DIP Switch Setting

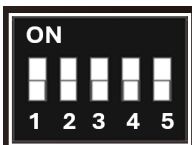

Switch No.	Function Name	State	Description
1	LFPT	On (Default)	Enables link fault pass-through. The link status on the TX port will inform the FX port of the same device and vice versa.
		Off	Disables link fault pass-through. The link status on the TX port will not inform the FX port.
2	Operating Mode	On (Default)	Selects store-and-forward mode. It forwards packets to a destination port once it receives the entire packet. The latency depends on the packet length.
		Off	Selects cut-through mode. Operates with minimum latency. The internal MIIs interconnect both transceivers, and they do not use the internal switch engine and data buffer.
3	Reserved	On	Reserved
		Off (Default)	
4	PoE	On (Default)	Enables PoE; the PoE converter provides power to the powered device (PD).
		Off	Disables PoE; the PoE converter does NOT provide power to the PD.
5	P.R.R. (Power Remote Reset)	On	Enables the P.R.R. function, when the fiber port link is down for 3 seconds and the PoE setting is enabled (On status); the PoE converter stops providing power to the PD, which means the PD power will turn OFF. After 1 second, the PoE converter continues to provide power to the PD, and then the PD power is turned back ON for reset PD.
		Off (Default)	Disables the PSE reset function; no reset PD function.

LED Indicators

The front panel of the IMC-P21GA-G2 contains several LED indicators. The function of each LED is described in the table below.

SFP Type (IMC-P21GA-G2)

LED	Color	State	Description
PWR1	Green	On	Power is being supplied to power input PWR1.
		Off	Power is not being supplied to power input PWR1.
PWR2	Green	On	Power is being supplied to power input PWR2.
		Off	Power is not being supplied to power input PWR2.
1 (Ethernet)	Green	On	Ethernet port 1000 Mbps link is active.
		Blinking	Data is being transmitted at 1000 Mbps.
		Off	Ethernet port is inactive.
	Amber	On	Ethernet port 10/100 Mbps link is active.
		Blinking	Data is being transmitted at 10/100 Mbps.
		Off	Ethernet port is inactive.
2 (Fiber Link)	Green	On	Fiber port is active.
		Blinking	Data is being transmitted at 1000 Mbps.
		Off	1000Base-FX port is inactive.
	Amber	On	Fiber port is active.
		Blinking	Data is being transmitted at 100 Mbps.
		Off	100Base-FX port is inactive.
PoE (PSE Indicator)	Green	On	The PoE device is connected by the IEEE 802.3at standard.
		Off	Power is not being supplied to the PD.
	Amber	On	The PoE device is connected by the IEEE 802.3af standard.
		Off	Power is not being supplied to the PD.
	Red	On	PD detects failure.
		Blinking (4 times/ sec)	Overcurrent has occurred on the PD.
		Off	PoE is operating normally.

Fixed Type (IMC-P21GA-G2-SX-SC, IMC-P21GA-G2-LX-SC)

LED	Color	State	Description
PWR1	Green	On	Power is being supplied to power input PWR1.
		Off	Power is not being supplied to power input PWR1.
PWR2	Green	On	Power is being supplied to power input PWR2.
		Off	Power is not being supplied to power input PWR2.
1 (Ethernet)	Green	On	Ethernet port 1000 Mbps link is active.
		Blinking	Data is being transmitted at 1000 Mbps.
		Off	Ethernet port is inactive.
	Amber	On	TP port's 10/100 Mbps link is active.
		Blinking	Data is being transmitted at 10/100 Mbps.
		Off	TP Port's 10 Mbps link is inactive.
2 (Fiber Link)	Green	On	FX port's 1000 Mbps is active.
		Blinking	Data is being transmitted at 1000 Mbps.
		Off	1000Base-FX port is inactive.
PoE (PSE Indicator)	Green	On	The PoE device is connected by the IEEE 802.3at standard.
		Off	Power is not being supplied to the PD.
	Amber	On	The PoE device is connected by the IEEE 802.3af standard.
		Off	Power is not being supplied to the PD.
	Red	On	PD detects failure.
		Blinking (4 times/ sec)	Overcurrent has occurred on the PD.
		Off	PoE is operating normally.

Specifications

Technology		
Standards	IEEE802.3, 802.3u, Link Fault Pass-through (LFPT), IEEE802.3at, IEEE802.3af	
Interface		
RJ45 Ports	10/100/1000Base-T(X)	
Fiber Ports	1000Base-FX (SC connectors available)	
LED Indicators	Power, Ethernet, Fiber, PoE	
Dip Switch	LFPT, Operating Mode, PoE, P.R.R	
Optical Fiber		
	Multi-mode (IMC-P21GA-G2-SX-SC)	Single-mode (IMC-P21GA-G2-LX-SC)
Distance, km	0.5	10
Wavelength, nm	850	1310
Min. TX Output, dBm	-10	-9
Max. TX Output, dBm	-3	-3
Sensitivity, dBm	-20	-21
Power Requirements		
Input Voltage	44-57 VDC, Dual Power Inputs	
Input Current	828 mA max	
Connection	Removable Terminal Block	
Overload Current Protection	1.5 A	
Reverse Polarity Protection	Present	
Physical Characteristics		
Casing	IP40 with I/O plugs, SECC case	
Dimensions	20.3 x 73 x 90 mm	
Installation	DIN rail, wall mounting (optional)	
Environmental Limitations		
Operating Temperature	-10 to 60°C (32 to 140°F)	
Storage Temperature	-40 to 85°C (-40 to 185°F)	
Ambient Relative Humidity	5 to 90% (non-condensing)	
Regulatory Approvals		
Safety	UL 62368	
EMI	CISPR 22, FCC Part 15B Class B	
EMS	IEC 61000-4-2 ESD: Contact: 6 kV; Air: 8 kV IEC 61000-4-3 RS: 80 MHz to 1 GHz: 10 V/m IEC 61000-4-4 EFT: Power: 2 kV; Signal: 1 kV IEC 61000-4-5 Surge: Power: 2 kV; Signal: 1 kV IEC 61000-4-6 CS: Signal: 10 V	
Shock	IEC 60068-2-27	
Freefall	ISTA-1A	
Vibration	IEC 60068-2-64 IEC 60068-2-6	
Warranty		
Warranty Period	5 years	
Details	See www.moxa.com/warranty	



Caution

This equipment must use Laser Class 1 optical transceiver.



Caution

- This is a Class 1 (IEC 60825:2014) laser/LED product. Do not stare into the laser beam.
 1. Caution—Use of the controls or adjustments or the performance of procedures other than those specified herein may cause hazardous radiation exposure.
 2. Complies with 21 CFR 1040.10 and 1040.11, except for conformance with IEC 60825-1 Ed. 3., as described in Laser Notice No. 56, dated May 8, 2019.
- Before connecting the equipment to DC power inputs, make sure the DC power source voltage is stable
 - The wiring of input terminal block shall be installed by a skilled person.
 - Wire type: Cu
 - Only use 16-24 AWG wire size.
- The product is intended to be supplied by a UL Listed Power Unit is rated 44-57 VDC @ 828 mA min., T_{ma} = 60°C (min.). If you need further help with purchasing the power source, please contact Moxa for further information.
- If using a Class I adapter, the power cord must be connected to a socket-outlet with an earthing connection.
- The product is considered not likely to require a connection to an Ethernet network with outside plant routing.

NOTE PoE output specification (IEEE802.3af)

44-57 VDC, 94 mA max. (PoE Class 1)
44-57 VDC, 185 mA max. (PoE Class 2)
44-57 VDC, 388 mA max. (PoE Class 3)
44-57 VDC, 750 mA max. (PoE Class 4)
(44-48 VDC, 33 W max.)
(48-57 VDC, 36 W max.)