

# **MDS-G4000/MDS-G4000-L3 Series Quick Installation Guide**

---

**Version 1.2, June 2021**

**Technical Support Contact Information**  
**[www.moxa.com/support](http://www.moxa.com/support)**

**MOXA<sup>®</sup>**

© 2021 Moxa Inc. All rights reserved.

**P/N: 180204000004**



## Package Checklist

Moxa's MDS-G4000/MDS-G4000-L3 Series industrial modular DIN-rail switch is shipped with the following items. If any of these items are missing or damaged, please contact your customer service representative for assistance.

- 1 MDS-G4000 or MDS-G4000-L3 Series switch
- RJ45-to-RS-232 9-pin female console cable
- 2 protective caps for unused ports
- Pre-installed DIN-rail kit
  - MDS-G4012 and MDS-G4012-L3: x 1
  - MDS-G4020 and MDS-G4020-L3: x 2
  - MDS-G4028 and MDS-G4028-L3: x 2
- Quick installation guide (printed)
- Substance Disclosure Table
- Product Certificate of Quality Inspection (Simplified Chinese)
- Product Notices (Simplified Chinese)
- Warranty card

**NOTE** You can find information and software downloads on the relevant product pages located on Moxa's website:

[www.moxa.com](http://www.moxa.com)

## Default Settings

- IP address: 192.168.127.253
- Subnet Mask: 255.255.255.0
- Username: admin
- Password: moxa

## Panel Layouts

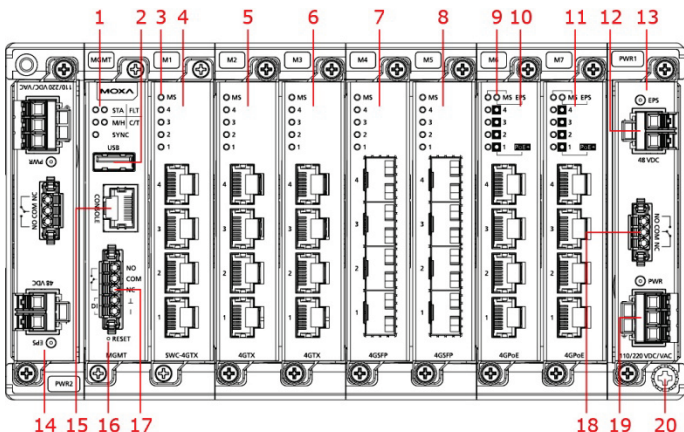

1. System status LEDs (from left to right, top to bottom) STATE, FAULT, MASTER/HEAD, COUPLER/TAIL, and SYNC LED indicators
2. USB port (Reserved for future use)

3. Module status
4. Switch and Control module slot 1 (Embedded)
5. Ethernet module slot 2
6. Ethernet module slot 3
7. Ethernet module slot 4 (For MDS-G4020/28, MDS-G4020/28-L3)
8. Ethernet module slot 5 (For MDS-G4020/28, MDS-G4020/28-L3)
9. External power input status from EPS
10. Ethernet module slot 6 (For MDS-G4028, MDS-G4028-L3)
11. Ethernet module slot 7 (For MDS-G4028, MDS-G4028-L3)
12. External power supply input for PoE
13. Redundant power module slot 1
14. Redundant power module slot 2
15. RS232 console port with RJ45 interface
16. Reset button (Pin hole 0.9 mm)
17. Relay output and Digital Input port
18. Relay output
19. Power input
20. Grounding screw

## Dimensions

### MDS-G4012 and MDS-G4012-L3 Series

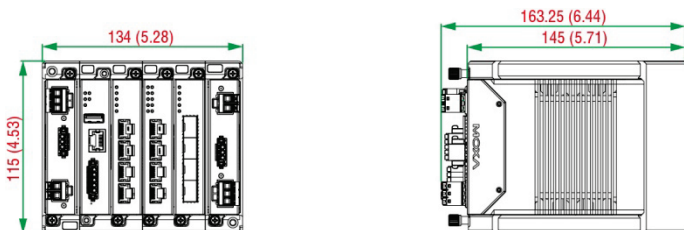

### MDS-G4020 and MDS-G4020-L3 Series

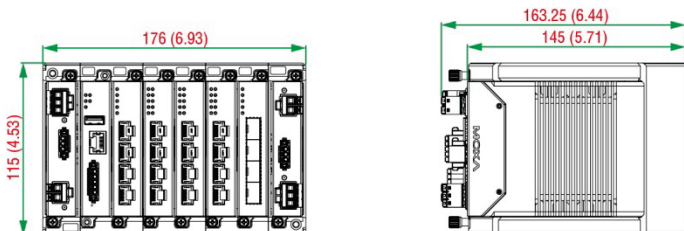

### MDS-G4028 and MDS-G4028-L3 Series

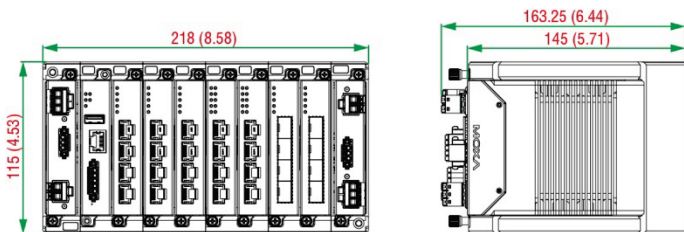

Unit: mm (inch)

## Ethernet Modules (Hardware Rev.2.0.0 and above)

**NOTE** Transceivers for the LM-7000H-4GSFP module are sold separately. Refer to [Supported SFP Modules](#) for list of supported transceivers.

### LM-7000H-4GTX

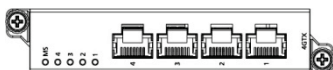

### LM-7000H-4GSFP



### LM-7000H-4GPoE

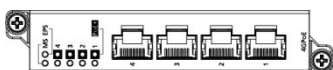

### LM-7000H-4TX

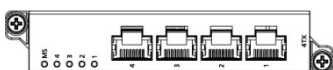

### LM-7000H-4PoE

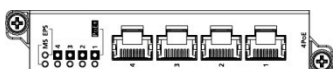

## Power Modules (Hardware Rev.2.1.0 and above)

**NOTE** The PWR-LV-P48 power module is certified for Hazardous Location use.

### PWR-HV-P48



### PWR-LV-P48

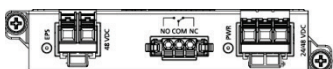

### PWR-HV-NP



### PWR-LV-NP



## DIN-rail Dimensions and Instructions

**NOTE** The DIN rail kit is certified for Hazardous Location usage.

### MDS-G4012 and MDS-G4012-L3 Series

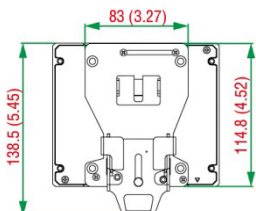

Unit: mm (inch)

## MDS-G4020/28 and MDS-G4020/28-L3 Series

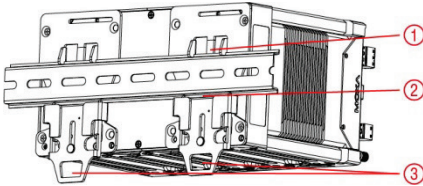
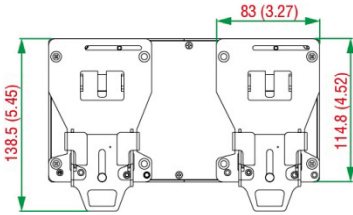

1. Insert the upper lip of the DIN rail into the DIN-rail mounting kit.
2. Press the device towards the DIN rail until it snaps into place.
3. Pull down the two latches one by one to release the DIN-rail kit and lift up to remove the device from the DIN rail.

**NOTE** The DIN rail must use the TS35 (15 mm) specification.

## Wall-mounting Dimensions and Instructions

### (Optional: WK-112-01)

**NOTE** The wall-mount kit is certified for Hazardous Location usage.

Mounting the switch to a wall requires four screws. The heads of the screws should be between 6.0 to 9.0 mm in diameter, and the diameter of screw thread should be between 3.5 to 4 mm, as shown in the figure on the right. Use the switch with the wall-mounting kit attached as a guide to mark the correct locations of the eight screws.

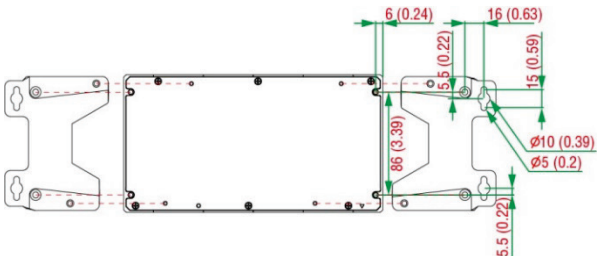
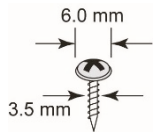

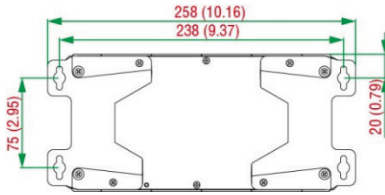

## Rack-mounting Dimensions and Instructions (Optional: RK-3U-01)

The rack mount kit is designed for two MDS-G4028 or MDS-G4028-L3 products.

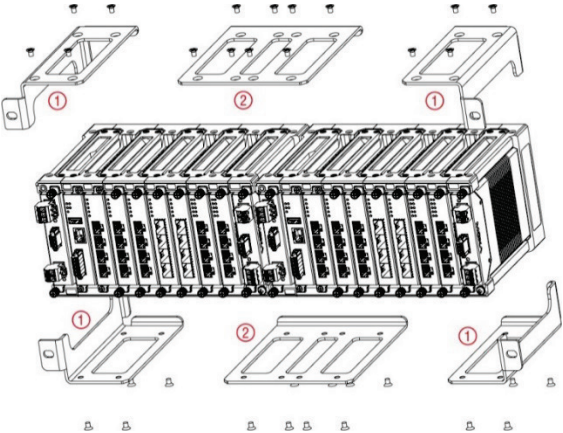

1. Assemble the right and left part of the kit (indicated with No. 1 in the diagram) with four screws each.
2. Assemble the part of the rack kit (indicated with No. 2 in the diagram) with eight screws in order to combine two MDS-G4028 or MDS-G4028-L3 products.

### Rack Mount Top View

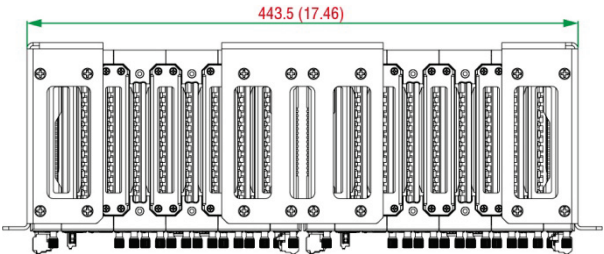

## **Rack Mount Front View**

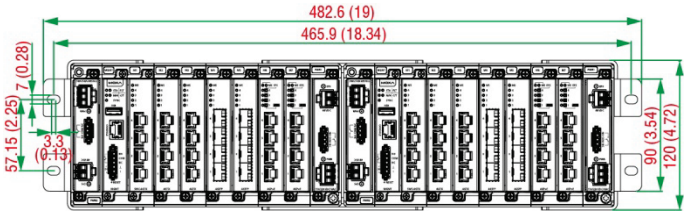

## **Rack Mount Rear View**

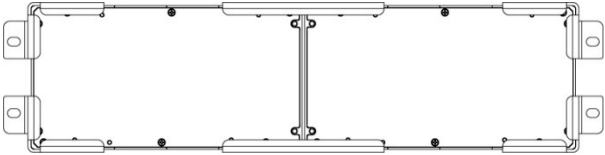

## **Matters That Require Attention**

- 1. Elevated Operating Temperature:** If installed in a closed or multi-unit rack assembly, the operating ambient temperature of the rack environment may be greater than room temperature. Therefore, consideration should be given to installing the equipment in an environment compatible with the maximum ambient temperature (T<sub>ma</sub>) specified by the manufacturer.

**NOTE** In order to ensure reliable operations, please make sure the operating temperature of the environment does not exceed the spec. When mounting a rack-mounted switch with other operating units in a cabinet without forced ventilation, it is recommended that 1U of space is reserved between each rack-mounted switch and/or device.

- 2. Required Air Flow:** Installation of the equipment in a rack should be such that the amount of air flow required for safe operation of the equipment is not compromised.

**NOTE** The optimal keep-out zone is 50 mm for the top, bottom, left, and right side of the device.

- 3. Mechanical Loading:** Mounting of the equipment in the rack should be such that a hazardous condition is not achieved due to uneven mechanical loading.
- 4. Circuit Overloading:** Consideration should be given to the connection of the equipment to the supply circuit and the effect that overloading of the circuits might have on overcurrent protection and supply wiring. Appropriate consideration of equipment nameplate ratings should be used when addressing this concern.
- 5. Reliable Grounding:** Reliable grounding of rack-mounted equipment should be maintained. Particular attention should be

given to supply connections other than direct connections to the branch circuit (e.g. use of power strips).



## **ATTENTION**

### **Safety First!**

Be sure to disconnect the power cord before installing and/or wiring your Ethernet Switch. Calculate the maximum possible current in each power wire and common wire. Observe all electrical codes dictating the maximum current allowable for each wire size. If the current goes above the maximum ratings, the wiring could overheat, which can cause serious damage to your equipment.

## **Connecting the Power Inputs**

The MDS-G4000 and MDS-G4000-L3 Series support 4 types of power supply:

- PWR-HV-P48: one 110/220 VAC/VDC (90 to 264 VAC, 88 to 300 VDC), one 48 VDC PoE power input for PoE+ ports.
- PWR-LV-P48: one 24/48 VDC (18 to 72 VDC), one 48 VDC PoE power input for PoE+ ports.

**NOTE** The PWR-LV-P48 power module is certified for Hazardous Location use.

- PWR-HV-NP: one 110/220 VAC/VDC (90 to 264 VAC, 88 to 300 VDC) power input.
- PWR-LV-NP: one 24/48 VDC (18 to 72 VDC) power input.

For the PWR-HV-P48, the 110/220 VAC/VDC power supplies provide power to the switch. Separate 48 VDC power supplies are required to provide power to all PoE+ ports (50 to 57 VDC is recommended for IEEE 802.3at devices. The max. PoE output from an external power supply is 720 W when the operating temperature is under 60°C; 360 W when the operating temperature is under 75°C.).

For the PWR-LV-P48 models, the 24/48 VDC power supplies provide power to the switch. Separate 48 VDC power supplies are required to provide power to all PoE+ ports (50 to 57 VDC is recommended for IEEE 802.3at devices. The max. PoE output from an external power supply is 720 W when the operating temperature is under 60°C; 360 W when the operating temperature is under 75°C.).





## ATTENTION

### For Hazardous Location Use

The PoE capacity of the PWR-LV-P48 is only certified for use in hazardous locations up to a maximum power budget of 369.6 W and a maximum output of up to 15.4 W per port.

For the PWR-HV-NP, the 110/220 VAC/VDC power supplies provide power to the switch.

For the PWR-LV-NP, the 24/48 VDC power supplies provide power to the switch.

## Power Terminal Blocks

The connection for power input and PoE external power supply is on the power modules.



### PWR-HV-P48/PWR-HV-NP

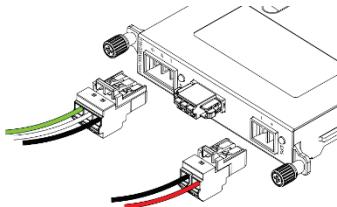

1. Insert the neutral/line (L/N/Ground) AC wires into the terminals.
2. Insert the terminal block connector into the terminal block receptor.

### PWR-LV-P48/PWR-LV-NP

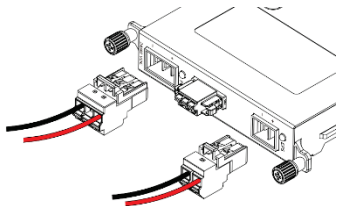

1. Remove 8 to 9 mm of the DC wires' protective cover.
2. Use a tool to push the spring mechanism inwards to open it.
3. Insert the negative/positive (-/+ ) DC wires into the terminals.
4. Release the spring mechanism.
5. Insert the terminal block connector prongs into the terminal block receptor.

## PoE Power Terminal Blocks

1. Remove 8 to 9 mm of the DC wires' protective cover.
2. Use a tool to push the spring mechanism inwards to open it.
3. Insert the negative/positive (-/+ ) DC wires into the terminals.
4. Release the spring mechanism.
5. Insert the terminal block connector prongs into the terminal block receptor.

**NOTE** In order to have higher levels of protection against surge, it is suggested to install a surge protector in front of the power input of the PoE powered device so that it is suitable for use in IEC 61850 conditions.

**NOTE** When wiring the power input, we suggest using the cable type - AWG (American Wire Gauge) 16-20 (1.31-0.519 mm<sup>2</sup>) and the corresponding pin type cable terminals. The rated temperature of wiring should be at least 105°C.

**NOTE** When wiring the PoE power input, we suggest using the cable type - AWG (American Wire Gauge) 16 (1.31 mm<sup>2</sup>) and the corresponding pin type cable terminals. The rated temperature of wiring should be at least 105°C.

**NOTE** When two power units are installed on the switch, both power units will be activated simultaneously, which will enable power redundancy.

**NOTE** The reverse power input connection will not activate the device or PoE input. In addition, the PoE will only activate when the external power supply is installed on the same power unit.

## Wiring the Relay Contact

Each power module has one relay output that can provide two types of relay output. Refer to the table below for detailed information.

The relay contact is used to detect user-configured events. Two wires are attached to the relay pins with normally close and normally open options.

1. Remove 8 to 9 mm of the DC wires' protective cover.
2. Use a tool to push the spring mechanism inwards to open it.
3. Insert the wires into the terminals.
4. Release the spring mechanism.
5. Insert the terminal block connector prongs into the terminal block receptor.

### **FAULT:**

The relay contact of the 3-pin terminal block connector is used to detect user-configured events. The module provides normally open and normally closed circuits depending on what the user chooses. For pin definitions refer to the table below.

<b>Relay Connection</b>	<b>Power Off</b>	<b>Boot up Ready</b>	<b>Event Trigger</b>
NO and COM	Closed Circuit	Open Circuit	Closed Circuit
NC and COM	Open Circuit	Closed Circuit	Open Circuit

**NOTE** When wiring the relay contact, we suggest using the cable type - AWG (American Wire Gauge) 16-20 (1.31-0.519 mm<sup>2</sup>) and the corresponding pin type cable terminals. The rated temperature of wiring should be at least 105°C.

## Digital Input/Output

### **Digital Output**

1 relay output with current carrying capacity of 2 A @ 30 VDC

**NOTE** For Hazardous Location certified models, the current carrying capacity is 1 A @ 30 VDC.

### **Digital Input**

1 digital output with the same ground, but electrically isolated from the electronics

- +13 to +30 V for state 1
- -30 to +1 V for state 0
- Max. input current: 8 mA

### **Wiring the Digital Input/Output**

**NOTE** When wiring the digital input, we suggest using the cable type - AWG (American Wire Gauge) 16-28 (1.31-0.0804 mm<sup>2</sup>) and the corresponding pin type cable terminals. The rated temperature of wiring should be at least 105°C.

1. Remove 8 to 9 mm of the DC wires' protective cover.
2. Use a tool to push the spring mechanism inwards to open it.
3. Insert the wires into the terminals.
4. Release the spring mechanism.
5. Insert the terminal block connector prongs into the terminal block receptor.

## Installing and Removing the Ethernet Modules

The Ethernet modules are hot-swappable for the same module type. You have the option to mount or remove the Ethernet module while the device is operating.

**NOTE** When performing a cold start, you cannot remove and insert a module before booting up as it will cause the module to initially fail.

**NOTE** The default module is 4GTX, if it is the first time you are mounting a 4TX, PoE, or SFP module, please reboot the switch after inserting it. The hot-swappable function, as defined above, will only work after the device is rebooted for the first time.

**NOTE** If a different model type module is changed on the same slot, it is recommended to reconfigure the settings or reset the device to default settings after rebooting the switch.

To install an Ethernet module:

1. Insert the Ethernet module straight into the slot.
2. Fasten the module to the device by tightening the 2 screws. The tightening torque is 3.5 kgf-cm (0.35 Nm).

To remove an Ethernet module:

1. Loosen the 2 screws of the module.
2. Pull the module out of the slot.
3. Insert the dummy module into the slot in order to have better protection against dust and EMI.
4. Fasten the dummy module using 2 screws. The tightening torque is 4 kgf-cm (0.4 Nm).

## Installing and Removing the Power Modules

The power supply units are hot-swappable when both power modules are installed. You have the option to mount or remove the power supply units while the device is operating.

To install a power module:

1. Insert the power unit straight into the slot
2. Fasten the unit to the device by tightening the 2 screws. The tightening torque is 3.5 kgf-cm (0.35 Nm)

To remove a power module:

1. Loosen the 2 screws of the module
2. Pull the module out of the slot
3. Insert the dummy module in to the slot in order to have better protection against dust and EMI.
4. Fasten the dummy module using 2 screws. The tightening torque is 4 kgf-cm (0.4 Nm)

**NOTE** If one of the modules is removed from the device, it is advisable to insert a dummy module in order to provide better protection against dust and EMI.

## Grounding the Moxa Industrial DIN-rail Switch

Grounding and wire routing help limit the effects of noise due to electromagnetic interference (EMI). Run the ground connection from the ground screw to the grounding surface prior to connecting devices.

**NOTE** Using a shielded cable achieves better electromagnetic resistance.

**NOTE** When grounding, we suggest using the cable type - AWG (American Wire Gauge) 16 (1.31 mm<sup>2</sup>).

## RS-232 with RJ45 Interface Console Connection

The switch has an RS-232 serial console with an RJ45 interface. Use a Moxa 9-pin female console cable to connect to your PC's COM port (or via USB-to-Serial converters or hubs). You can then use a console terminal program, such as Moxa's PComm Terminal Emulator, to access the console configuration utility of the switch.

RS-232 Setup:

- Baud rate: 115,200
- Data Bits: 8
- Parity: None
- Stop Bits: 1
- Terminal Type: VT100

## USB Connection

The USB connection is reserved for functions that may be required in the future.

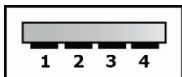

Pin	Description
1	VCC (+5V)
2	D- (Data-)
3	D+ (Data+)
4	GND (Ground)

## The Reset Button (Diameter 0.9 mm)

The reset button can perform two functions. One is to reset the switch to factory default settings and the other is to reboot the switch if the button has been depressed and release immediately.

### Reset to Factory Default Settings

Depress the Reset button for five seconds to load the factory default settings. Use a pointed object, such as a straightened paper clip or needle (the diameter must not exceed 0.9 mm), to depress the Reset button. When you do so, the STATE LED will start to blink about four times per second. Continue to depress the STATE LED until it begins blinking more rapidly; this indicates that the button has been depressed for five seconds and you can release the Reset button to load factory default settings.

**NOTE** DO NOT power off the switch when loading default settings.

## LED Indicators

The function of each LED is described in the table below.

LED	Color	State	Description
<b>System LEDs</b>			
STA (STATE)	Green	On	Normal operation.
		Blinking	1. The system is booting up.
		Off	N/A
FLT (FAULT)	Red	On	1. Switch failed to initialize. 2. EEPROM information error.
		Blinking	When the switch boots up and the firmware loads to memory.
		Off	The system is operating normally.
M/H (MSTR/ HEAD)	Green	On	When the switch is the Master/Head of Turbo Ring/Turbo Chain.
		Blinking	When the switch is Ring Master/Head of Turbo Ring/Turbo Chain and the Turbo Ring/Turbo Chain is broken.
		Off	When the switch is not the Master/Head of this Turbo Ring/Turbo Chain.
C/T (CPRL/TAIL)	Green	On	1. When the switch enables the coupling function to form a back-up path, or 2. When the switch is the tail of Turbo Chain.
		Blinking	This is the switch that enables Turbo Chain, but the Turbo Chain function is not working.
		Off	When the switch disables the coupling or tail role of Turbo Chain.
SYNC (Reserved)	Amber	On	The PTP function is enabled.
		Blinking	The switch receives sync packets.
		Off	The PTP function is disabled.
	Green	On	The PTP function has successfully converged.
System LED (Except PWR)	Green/ Amber/ Red	Blinking	The switch is being discovered/located by the locator function. The system LEDs include the STA, FLT, M/H, C/T, and SYNC LEDs.

## SWC-4GTX

LED	Color	State	Description
MS (Module State)	Green	On	Normal operation.
		Blinking	This module is booting up.
		Off	The module is out of service.
	Red	On	1. The module failed to initialize. 2. A module designed for a different model was inserted.
Copper (10/100/ 1000Mbps)	Green	On	When the port is active and links on 1,000 Mbps.
		Blinking	When the port's data is being transmitted at 1,000 Mbps.
		Off	When the port is inactive or link down.
	Amber	On	When the port is active and links on 10/100 Mbps.
		Blinking	When the port's data is being transmitted at 10/100 Mbps.



## LM-7000H-4GTX/LM-7000H-4GSFP/LM-7000H-4TX

LED	Color	State	Description
MS (Module State)	Green	On	Normal operation.
		Blinking	This module is booting up.
		Off	The module is out of service.
	Red	On	1. The module failed to initialize. 2. A module designed for a different model was inserted.
Copper (10/100 Mbps)	Green	On	When the port is active and links on at 100 Mbps.
		Blinking	When the port's data is being transmitted at 100 Mbps.
		Off	When the port is inactive or link down.
	Amber	On	When the port is active and links on 10 Mbps.
		Blinking	When the port's data is being transmitted at 10 Mbps.
		Off	When the port is inactive or link down.
Copper (10/100/ 1000Mbps)	Green	On	When the port is active and links on 1,000 Mbps.
		Blinking	When the port's data is being transmitted at 1,000 Mbps.
		Off	When the port is inactive or link down.
	Amber	On	When the port is active and links on 10/100 Mbps.
		Blinking	When the port's data is being transmitted at 10/100 Mbps.
		Off	When the port is inactive or link down.
SFP (100/1000 Mbps)	Green	On	When the port is active and links on 1,000Mbps.
		Blinking	When the port's data is being transmitted at 1,000 Mbps.
		Off	When the port is inactive or link down.
	Amber	On	When the port is active and links on 100 Mbps.
		Blinking	When the port's data is being transmitted at 100 Mbps.
		Off	When the port is inactive or link down.

## LM-7000H-4GPoE/LM-7000H-4PoE

LED	Color	State	Description
MS (Module State)	Green	On	Normal operation.
		Blinking	The module is booting up.
		Off	This module is out of service.
	Red	On	1. The module failed to initialize. 2. A user inserted a module designed for a different model. 3. When performing a cold start, the module was removed and inserted before initialization was complete.
EPS (External Power Supply for PoE module)	Amber	On	Normal operation.
		Off	No external power supply for PoE.
Copper (10/100 Mbps)	Green	On	When the port is active and links on 100 Mbps.
		Blinking	When the port's data is being transmitted at 100 Mbps.
		Off	When the port is inactive or link down.
	Amber	On	When the port is active and links on 10 Mbps.
		Blinking	When the port's data is being transmitted at 10 Mbps.
		Off	When the port is inactive or link down.
Copper (10/100/1000Mbps)	Green	On	When the port is active and links on 1,000 Mbps.
		Blinking	When the port's data is being transmitted at 1,000 Mbps.
		Off	When the port is inactive or link down.
	Amber	On	When the port is active and links on 10/100Mbps.
		Blinking	When the port's data is being transmitted at 10/100 Mbps.
		Off	When the port is inactive or link down.
PoE/PoE+	Green	On	When the port is connected to IEEE 802.3at powered device (PD).
		Off	1. When the power is not being supplied to a powered device (PD), or 2. The port is not connected to an IEEE 802.3at standard PD.
	Amber	On	When the port is connected to IEEE 802.3af powered device (PD).
		Blinking	The PoE power has been shut off because of low power budget.
	Red	On	Powered device (PD) detection failure.
		Blinking	When detecting over current or short circuit on the powered Device (PD).

## PWR-HV-P48/PWR-LV-P48

LED	Color	State	Description
EPS (External Power Supply)	Amber	On	External power is being supplied to the module's EPS input.
		Off	No external power supply for PoE.
PWR	Amber	On	Power is being supplied to the module's power input.
		Off	Power is not being supplied to the module's power input.

## PWR-HV-NP/PWR-LV-NP

LED	Color	State	Description
PWR	Amber	On	Power is being supplied to the module's power input.
		Off	Power is not being supplied to the module's power input.

## Specifications

Interface	
Gigabit Ethernet	4-ports 10/100/1000BaseT(X)
Console Port	RS-232 console with an RJ45 interface
LED Indicators	PWR, EPS, STATE, SYNC, FAULT, MSTR/HEAD, CPLR/TAIL
Relay Output	2 A @ 30 VDC (for Hazardous Location certified models, the current carrying capacity is 1 A @ 30 VDC.)
Power Requirements	
Input Voltage	<b>PWR-HV-P48:</b> 110/220 VDC, 110 VAC, 60 Hz, 220 VAC, 50 Hz, PoE: 48 VDC <b>PWR-LV-P48 (certified for Hazardous Location use):</b> 24/48 VDC PoE: 48 VDC <b>PWR-HV-NP:</b> 110/220 VDC, 110 VAC, 60 Hz, 220 VAC, 50 Hz <b>PWR-LV-NP:</b> 24/48 VDC
Operating Voltage	<b>PWR-HV-P48:</b> 88 to 300 VDC, 90 to 264 VAC, 47 to 63 Hz, PoE: 46 to 57 VDC <b>PWR-LV-P48:</b> 18 to 72 VDC (24 to 48 VDC for Hazardous Location), PoE: 46 to 57 VDC (48 VDC for Hazardous Location) <b>PWR-HV-NP:</b> 88 to 300 VDC, 90 to 264 VAC, 47 to 63 Hz <b>PWR-LV-NP:</b> 18 to 72 VDC

Power Consumption (without modules consumption)	<b>When using PWR-HV-P48:</b> 110 VDC: 12.43 W 220 VDC: 12.87 W 110 VAC: 13.42 W 220 VAC: 14.08 W <b>When using PWR-LV-P48:</b> 24 VDC: 12.67 W 48 VDC: 13.2 W
Power Consumption of module	LM-7000H-4GTX: 3.63 W LM-7000H-4GPoE: 3.8 W LM-7000H-4GSFP: 4.8 W LM-7000H-4TX: 1.85 W LM-7000H-4PoE: 1.85 W
Input Current (without modules consumption)	<b>When using PWR-HV-P48/PWR-HV-NP:</b> 110 VDC: 0.11 A 220 VDC: 0.06 A 110 VAC: 0.29 A 220 VAC: 0.18 A <b>When using PWR-LV-P48/PWR-LV-NP:</b> 24 VDC: 0.53 A 48 VDC: 0.28 A
Peak Inrush Current	<b>PWR-HV-P48/PWR-HV-NP:</b> 110 VAC: < 10 A (t > 0.1 ms) 220 VAC: < 20 A (t > 0.1 ms) <b>PWR-LV-P48/PWR-LV-NP:</b> 24 VDC: < 5 A (t > 0.1 ms) 48 VDC: < 10 A (t > 0.1 ms)
Maximum PoE Power Output per Port	36 W 15.4 W certified for Hazardous Location use
Total PoE Power Budget	Max. 360 W (with one power supply) for total PD consumption at 48 VDC input for PoE systems Max. 360 W (with one power supply) for total PD consumption at 53-57 VDC input for PoE+ systems Max. 720 W (with two power supplies) for total PD consumption at 48 VDC input for PoE systems Max. 720 W (two powers) for total PD consumption at 53-57 VDC input for PoE+ systems
Overload Current Protection	Present
Reverse Polarity Protection	Present
<b>Physical Characteristics</b>	
Ingress Protection Rating	IP40 (This rating will only be achieved when the relay output terminal block and all modules are installed.)
Dimensions	MDS-G4012/MDS-G4012-L3 Series: 134 x 115 x 163.25 mm MDS-G4020/ MDS-G4020-L3 Series: 176 x 115 x 163.25 mm MDS-G4028/MDS-G4028-L3 Series: 218 x 115 x 163.25 mm

Weight	MDS-G4012/MDS-G4012-L3 Series: 2.00 kg (4.41 lb) MDS-G4020/MDS-G4020-L3 Series: 2.50 kg (5.51 lb) MDS-G4028/MDS-G4028-L3 Series: 2.84 kg (6.26 lb) LM-7000H-4GSFP: 0.3 kg (0.66 lb) LM-7000H-4GTX: 0.24 kg (0.53 lb) LM-7000H-4GPoE: 0.31 kg (0.69 lb) LM-7000H-4TX: 0.24 kg (0.53 lb) LM-7000H-4PoE: 0.31 kg (0.69 lb) PWR-HV-P48/PWR-LV-P48: 0.36 kg (0.69 lb) PWR-HV-NP/PWR-LV-NP: 0.34 kg (0.75 lb)
Installation	DIN-rail mounting (certified for Hazardous Location use): Pre-installed by default Wall mount (certified for Hazardous Location use): WK-112-01 (with optional kit) 19" rack mounting: RK-3U-01 (optional, only for combining two 28-port models)
<b>Environmental Limits</b>	
Operating Temp.	Standard Temperature Models: -10 to 60°C (14 to 140°F) - MDS-G4012, MDS-G4012-L3 - MDS-G4020, MDS-G4020-L3 - MDS-G4028, MDS-G4028-L3  Wide Temperature Models: -40 to 75°C (-40 to 167°F) - MDS-G4012-T, MDS-G4012-L3-T - MDS-G4020-T, MDS-G4020-L3-T - MDS-G4028-T, MDS-G4028-L3-T
Storage Temp.	-40 to 85°C (-40 to 185°F)
Ambient Relative Humidity	5 to 95% (non-condensing)
<b>Standards and Certifications</b>	
Safety	EN 62368-1, UL 62368-1, IEC 62368-1
EMC	EN 55035/55032
EMI	CISPR 32, FCC Part 15B Class A
EMS	IEC 61000-4-2 ESD: Contact: 8 kV; Air: 15 kV IEC 61000-4-3 RS: 80MHz to 1GHz: 20 V/m IEC 61000-4-4 EFT: Power: 4 kV; Signal: 4 kV IEC 61000-4-5 Surge: Power 4 kV; Signal: 4 kV IEC 61000-4-6 CS: 10V IEC 61000-4-8 PFMF IEC 61000-4-11 Voltage Dips & Interruptions
<b>Note: For better conductive radiation immunity, it is recommended to use a STP cable and install a surge protector at the PoE power input: EPS.</b>	
Rail Traffic	EN 50121-4
Traffic Control	NEMA TS2
Shock	IEC 60068-2-27
Freefall	IEC 60068-2-31
Vibration	IEC 60068-2-6
Hazardous Location	Class I Division 2, ATEX
Power Substation	IEC 61850-3, IEEE 1613
<b>Warranty</b>	
Warranty Period	5 years

Details	See <a href="http://www.moxa.com/warranty">www.moxa.com/warranty</a>
---------	--

## Supported SFP Modules

Module	Description
SFP-1FEMLC-T	SFP module with 1 100Base multi-mode, LC connector for 2/4 km transmission, -40 to 85°C operating temperature
SFP-1FESLC-T	SFP module with 1 100Base single-mode with LC connector for 40 km transmission, -40 to 85°C operating temperature
SFP-1FELLC-T	SFP module with 1 100Base single-mode with LC connector for 80 km transmission, -40 to 85°C operating temperature
SFP-1G10ALC	WDM-type (BiDi) SFP module with 1 1000BaseSFP port with LC connector for 10 km transmission; TX 1310 nm, RX 1550 nm, 0 to 60°C operating temperature
SFP-1G10ALC-T	WDM-type (BiDi) SFP module with 1 1000BaseSFP port with LC connector for 10 km transmission; TX 1310 nm, RX 1550 nm, -40 to 85°C operating temperature
SFP-1G10BLC	WDM-type (BiDi) SFP module with 1 1000BaseSFP port with LC connector for 10 km transmission; TX 1550 nm, RX 1310 nm, 0 to 60°C operating temperature
SFP-1G10BLC-T	WDM-type (BiDi) SFP module with 1 1000BaseSFP port with LC connector for 10 km transmission; TX 1550 nm, RX 1310 nm, -40 to 85°C operating temperature
SFP-1G20ALC	WDM-type (BiDi) SFP module with 1 1000BaseSFP port with LC connector for 20 km transmission; TX 1310 nm, RX 1550 nm, 0 to 60°C operating temperature
SFP-1G20ALC-T	WDM-type (BiDi) SFP module with 1 1000BaseSFP port with LC connector for 20 km transmission; TX 1310 nm, RX 1550 nm, -40 to 85°C operating temperature
SFP-1G20BLC	WDM-type (BiDi) SFP module with 1 1000BaseSFP port with LC connector for 20 km transmission; TX 1550 nm, RX 1310 nm, 0 to 60°C operating temperature
SFP-1G20BLC-T	WDM-type (BiDi) SFP module with 1 1000BaseSFP port with LC connector for 20 km transmission; TX 1550 nm, RX 1310 nm, -40 to 85°C operating temperature
SFP-1G40ALC	WDM-type (BiDi) SFP module with 1 1000BaseSFP port with LC connector for 40 km transmission; TX 1310 nm, RX 1550 nm, 0 to 60°C operating temperature
SFP-1G40ALC-T	WDM-type (BiDi) SFP module with 1 1000BaseSFP port with LC connector for 40 km transmission; TX 1310 nm, RX 1550 nm, -40 to 85°C operating temperature

SFP-1G40BLC	WDM-type (BiDi) SFP module with 1 1000BaseSFP port with LC connector for 40 km transmission; TX 1550 nm, RX 1310 nm, 0 to 60°C operating temperature
SFP-1G40BLC-T	WDM-type (BiDi) SFP module with 1 1000BaseSFP port with LC connector for 40 km transmission; TX 1550 nm, RX 1310 nm, -40 to 85°C operating temperature
SFP-1GSXLC	SFP module with 1 1000BaseSX port with LC connector for 300m/550m transmission, 0 to 60°C operating temperature
SFP-1GSXLC-T	SFP module with 1 1000BaseSX port with LC connector for 300m/550m transmission, -40 to 85°C operating temperature
SFP-1GLSXLC	SFP module with 1 1000BaseLSX port with LC connector for 1km/2km transmission, 0 to 60°C operating temperature
SFP-1GLSXLC-T	SFP module with 1 1000BaseLSX port with LC connector for 1km/2km transmission, -40 to 85°C operating temperature
SFP-1GLXLC	SFP module with 1 1000BaseLX port with LC connector for 10 km transmission, 0 to 60°C operating temperature
SFP-1GLXLC-T	SFP module with 1 1000BaseLX port with LC connector for 10 km transmission, -40 to 85°C operating temperature
SFP-1GLHLC	SFP module with 1 1000BaseLH port with LC connector for 30 km transmission, 0 to 60°C operating temperature
SFP-1GLHLC-T	SFP module with 1 1000BaseLH port with LC connector for 30 km transmission, -40 to 85°C operating temperature
SFP-1GLHXLC	SFP module with 1 1000BaseLHX port with LC connector for 40 km transmission, 0 to 60°C operating temperature
SFP-1GLHXLC-T	SFP module with 1 1000BaseLHX port with LC connector for 40 km transmission, -40 to 85°C operating temperature
SFP-1GZXLC	SFP module with 1 1000BaseZX port with LC connector for 80 km transmission, 0 to 60°C operating temperature
SFP-1GZXLC-T	SFP module with 1 1000BaseZX port with LC connector for 80 km transmission, -40 to 85°C operating temperature
SFP-1GEZXC	SFP module with 1 1000BaseEZXC port with LC connector for 110 km transmission, 0 to 60°C operating temperature
SFP-1GEZXC-120	SFP module with 1 1000BaseEZXC port with LC connector for 120 km transmission, 0 to 60°C operating temperature
SFP-1GTXRJ45-T	SFP module with 1 1000BaseT port with RJ45 connector for 100 m transmission, -40 to 75°C operating temperature <b>Note:</b> This module is not certified for Hazardous Location.

## Restricted Access Locations

This equipment is intended to be used in Restricted Access Locations, such as a computer room, with access limited to service personnel or users who have been instructed on how to handle the metal chassis of equipment that is very hot. The location should only be accessible with a key or through a security system.

- External metal parts of this equipment are extremely hot. Before touching the equipment, you must take special precautions to protect your hands and body from serious injury.



## Special Conditions of Use

- The equipment shall only be used in an area of at least pollution degree 2, as defined in EN 60664-1.
- The equipment shall be installed in an enclosure that provides a degree of protection not less than IP 54 in accordance with EN 60079-15 and accessible only by the use of a tool.
- Transient protection device with capability of voltage clamping rating less than 119Vdc shall be provided externally of the PWR voltage supply terminal.



### ATTENTION

These devices are open-type devices that are to be installed in an enclosure with tool-removable cover or door, suitable for the environment.

This equipment is suitable for use in Class I, Division 2, Groups A, B, C, and D or non-hazardous locations only.



### WARNING—EXPLOSION HAZARD

Do not disconnect equipment unless power has been removed or the area is known to be non-hazardous.

Substitution of any components may impair suitability for Class I, Division 2.

## Hazardous Location Usage Terms

Usage Terms	
Models	MDS-G4012, MDS-G4012-T MDS-G4020, MDS-G4020-T MDS-G4028, MDS-G4028-T
Rating	Input: 24 to 48 VDC, 3.3 A (for PWR input) and 48 VDC, 8.2 A (for EPS input) Relay Output: 30 VDC/1 A Digital Input: 30 VDC/8 mA PoE Output: 48 VDC, 15.4 W per port



Conductors suitable for rated cable temperature	$\geq 105^{\circ}\text{C}$
Hazardous Location	EN 60079-0:2012+A11:2013, EN 60079-15:2010 Class I, Division 2, Groups A, B, C, and D
Address of manufacturer	No. 1111, Heping Rd., Bade Dist., Taoyuan City 334004, Taiwan

CID2		
 <p>I.T.E. for Use in Hazardous Locations 86CY Class I, Division 2 Groups A, B, C and D</p>	Temp. Code	T3B

ATEX		
	Temp. Code	165°C (T3)
	Certification Number	UL 20 ATEX 2415X
	Protection type code	Ex nA nC IIC 165°C (T3) Gc
	Warning	Do not open or disassemble the device while it is in operation