

AWK-3131A-RTG Series Quick Installation Guide

Industrial IEEE 802.11n wireless AP/client

Version 2.1, January 2021

Technical Support Contact Information
www.moxa.com/support

MOXA[®]

© 2021 Moxa Inc. All rights reserved.

P/N: 1802031312012



Overview

The AWK-3131A-RTG Series 3-in-1 industrial AP/client devices are designed specifically for train-to-ground communication for trains moving at speeds of up to 120 km/h. The AWK-3131A-RTG is compliant with mandatory sections of the EN 50155 standard, covering operating temperature, power input voltage, surge, ESD, and vibration, as well as conformal coating and power insulation, making the AWK-3131A-RTG suitable for a variety of industrial applications. Installation is easy, with DIN-rail mounting that makes it convenient to install the AP inside distribution boxes, and the wide operating temperature range and IP30 housing with LED indicators, make the AWK-3131A-RTG a convenient yet reliable solution for any rolling stock application.

Package Checklist

Before installing the AWK-3131A-RTG, verify that the package contains the following items:

- AWK-3131A-RTG wireless AP/client
- DIN-rail kit
- 2 plastic RJ45 protective cap: One for the console port and the other for use as a backup
- 1 plastic protective cap for fiber port (AWK-3131A-SSC-RTG only)
- Cable holder with one screw
- Quick installation guide (printed)
- Warranty card

If any of these items is missing or damaged, please contact your customer service representative for assistance.

NOTE Antennas are not included with the product and should be purchased separately. The AWK is certified for 2 dBi omni-directional antennas with QMA to RP-SMA adapters.

Installation and Configuration

Before installing the AWK-3131A-RTG, make sure that all items in the Package Checklist are in the box. In addition, you will need access to a notebook computer or PC equipped with an Ethernet port. The AWK-3131A-RTG has a default IP address that you must use when connecting to the device for the first time.

Step 1: Select the power source

The AWK-3131A-RTG can be powered by a DC power input or PoE (Power over Ethernet). The AWK-3131A-RTG will use whichever power source you choose.

Step 2: Connect the AWK to a notebook or PC

Since the AWK-3131A-RTG supports MDI/MDI-X auto-sensing, you can use either a straight-through cable or crossover cable to connect the AWK-3131A-RTG to a computer. If the LED indicator on the AWK-3131A-RTG's LAN port lights up, it means a connection has been established.

Step 3: Set up the computer's IP address

Update the computer's IP address so that the computer is on the same subnet as the AWK-3131A-RTG. Since the AWK-3131A-RTG's default IP address is 192.168.127.253, and the subnet mask is 255.255.255.0, you should set the IP address of the computer to 192.168.127.xxx and subnet mask to 255.255.255.0.

Step 4: Use the web-based manager to configure the AWK

Open your computer's web browser and type **http://192.168.127.253** in the address field to access the homepage of the web-based manager. Before the homepage opens, you will need to enter the user name and password. For first-time configuration, enter the default user name and password given below and then click on the **Login** button:

User name: **admin**

Password: **root**



ATTENTION

For security reasons, we strongly recommend changing the default password. To do so, select **Maintenance** → **Password**, and then follow the on-screen instructions.

Step 5: Select the AWK's operation mode

By default, the AWK-3131A-RTG's operation mode is set to AP. You can change the setting in **Wireless Settings** → **Basic Wireless Settings** if you would like to use the Client mode.

NOTE To make the change effective, click **Save Configuration** or **Restart**; either option saves all changes.

Panel Layout of the AWK-3131A-M12-RTG

Top Panel View

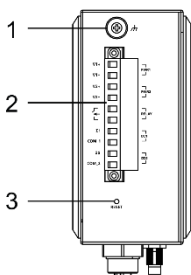

1. Grounding screw (M5)
2. Terminal block for PWR1, PWR2, relay, DI0, and DI1
3. Reset button
4. System LEDs: PWR1, PWR2, PoE, FAULT, and STATE LEDs
5. LEDs for signal strength
6. LEDs: CLIENT, WLAN, and LAN
7. RS-232 console port
8. 10/100BaseT(X) M12 port
9. Antenna port A
10. Antenna port B
11. Model name
12. Screw hole for wall-mounting kit
13. DIN-rail mounting kit

Front Panel View

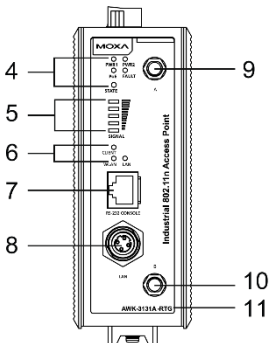

Rear Panel View

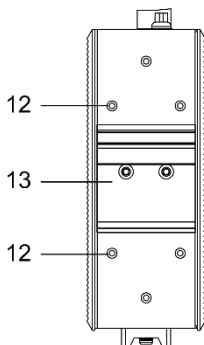

Panel Layout of the AWK-3131A-SSC-RTG

Top Panel View

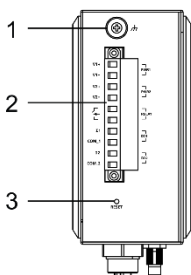

1. Grounding screw (M5)
2. Terminal block for PWR1, PWR2, relay, DI0, and DI1
3. Reset button
4. System LEDs: PWR1, PWR2, FAULT, and STATE LEDs
5. LEDs for signal strength
6. LEDs: CLIENT, WLAN, and 100M
7. RS-232 console port
8. 100BaseFX fiber port
9. Antenna port A
10. Antenna port B
11. Model name
12. Screw hole for wall mounting kit
13. DIN-rail mounting kit

Front Panel View

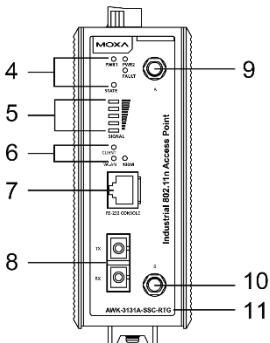

Rear Panel View

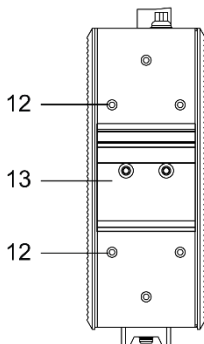

Mounting Dimensions (unit = mm)

AWK-3131A-M12-RTG

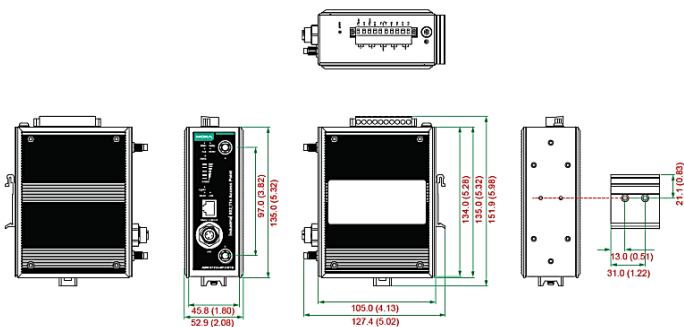

AWK-3131A-SSC-RTG

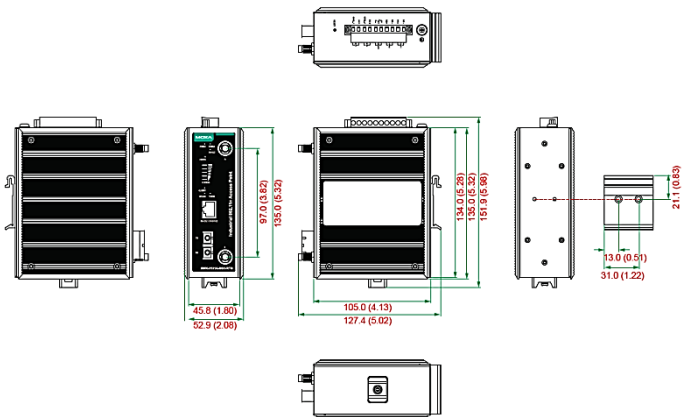

DIN-rail Mounting

The aluminum DIN-rail attachment plate should be fixed to the back panel of the AWK-3131A-RTG when you take it out of the box. If you need to reattach the DIN-rail attachment plate to the AWK-3131A-RTG, make sure the stiff metal spring is situated towards the top, as shown in the figures below:

STEP 1:

Insert the top of the DIN rail into the slot just below the stiff metal spring.

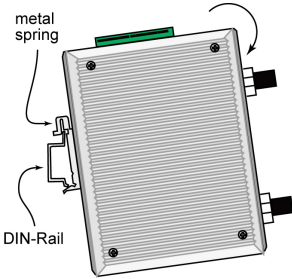
**STEP 2:**

The DIN-rail attachment unit will snap into place as shown below.

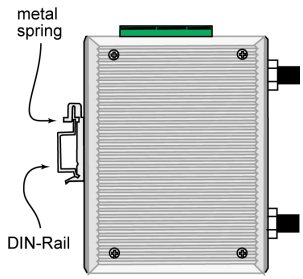

To remove the AWK-3131A-RTG from the DIN rail, simply reverse the steps 1 and 2.

Wall Mounting (Optional)

For some applications, it may be more convenient to mount the AWK-3131A-RTG to a wall, as illustrated below.

STEP 1:

Remove the aluminum DIN-rail attachment plate from the AWK-3131A-RTG, and then attach the wall mount plates with M5 screws, as shown in the diagrams.

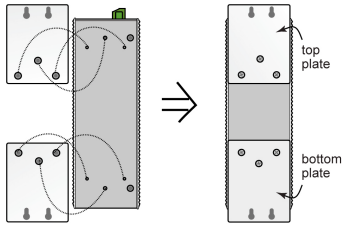
**STEP 2:**

Mounting the AWK-3131A-RTG to a wall requires 4 screws. Use the AWK-3131A-RTG with wall mount plates attached as a guide to mark the correct locations of the 4 screws. The heads of the screws should be less than 6.0 mm in diameter, and the shafts should be less than 3.5 mm in diameter, as shown in the figure at the right.

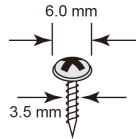

Do not screw the screws in all the way—leave a space of about 2 mm to allow room for sliding the wall mount panel between the wall and the screws.

NOTE Test the screw head and shank size by inserting the screw into one of the keyhole shaped apertures of the Wall Mounting Plates before it is screwed into the wall.

STEP 3:

Once the screws are fixed into the wall, insert the four screw heads through the large opening of the keyhole-shaped apertures, and then slide the AWK-3131A-RTG downwards, as indicated to the right. Tighten the four screws for added stability.

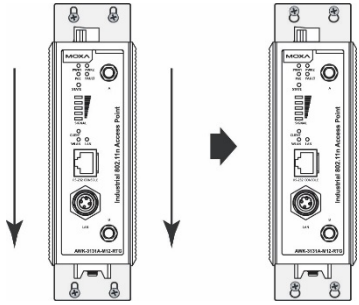

WARNING

- This equipment is intended to be used in a Restricted Access Location, such as a dedicated computer room, with access restricted to SERVICE PERSONNEL or USERS who have been instructed about the fact that the metal chassis of the equipment is extremely hot and may cause burns.
- Service personnel or users need to pay special attention and take special precautions before handling the equipment.
- Access is to be controlled through the use of a lock and key or a security identity system, controlled by the authority responsible for the location. Only authorized, well-trained professionals should be allowed to access the restricted access location.
- External metal parts are hot!! Pay special attention or use special protection before handling.

Wiring Requirements



WARNING

Safety First!

Be sure to disconnect the power cord before installing and/or wiring your Moxa AWK-3131A-RTG.



WARNING

Safety First!

Calculate the maximum possible current in each power wire and common wire. Observe all electrical codes dictating the maximum current allowed for each wire size. If the current goes above the maximum rating, the wiring could overheat, causing serious damage to your equipment.

You should also pay attention to the following items:

- Use separate paths to route wiring for power and devices. If power wiring and device wiring paths must cross, make sure the wires are perpendicular at the intersection point.
NOTE: Do not run signal or communications wiring and power wiring in the same wire conduit. To avoid interference, wires with different signal characteristics should be routed separately.
- You can use the type of signal transmitted through a wire to determine which wires should be kept separate. The rule of thumb is that wiring with similar electrical characteristics can be bundled together.
- Keep input wiring and output wiring separate.
- It is strongly advised that you label wiring to all devices in the system when necessary.



ATTENTION

This product is intended to be supplied by a Listed Power Unit marked "Class 2" or "LPS" and rated O/P:

- AWK-3131A-M12-RTG:
Maximum 10.5 W (12 V/0.85 A to 48 V/0.22 A), 25°C.
- AWK-3131A-SSC-RTG:
Maximum 13 W (12 V/1.0 A to 48 V/0.27 A), 25°C.



ATTENTION

Make sure the external power adapter (includes power cords and plug assemblies) provided with the unit is certified and suitable for use in your country.

Grounding the Moxa AWK-3131A-RTG

Grounding and wire routing help limit the effects of noise due to electromagnetic interference (EMI). Run the ground connection from the ground screw to the grounding surface prior to connecting devices.



ATTENTION

This product is intended to be mounted to a well-grounded mounting surface, such as a metal panel.

Installations with Unstable Power Inputs

There are cases where the device has to be wired to the same power source as other equipment. In such cases if equipment such as motors that are connected in the circuit draw a large amount of current during operation, the transient voltage drop could potentially cause the AWK to become unstable.

Installing a DC/DC power isolator, in between the two equipment, is recommended to isolate the transient effect and to ensure a stable power input for the AWK.

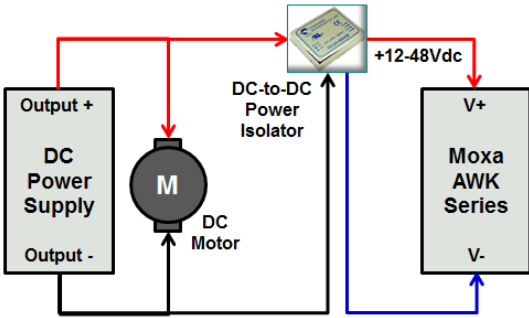

Wiring the Redundant Power Inputs

The top two pairs of contacts of the 10-contact terminal block connector on the AWK-3131A-RTG's top panel are used for the AWK-3131A-RTG's two DC inputs. Top and front views of the terminal block connector are shown here.

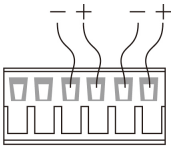

Top View

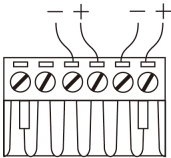

Front View

STEP 1:

Insert the negative/positive DC wires into the V-/V+ terminals.

STEP 2:

To keep the DC wires from pulling loose, use a small flat-blade screwdriver to tighten the wire-clamp screws on the front of the terminal block connector.

STEP 3:

Insert the plastic terminal block connector prongs into the terminal block receptor, which is located on the AWK-3131A-RTG's top panel.



ATTENTION

Before connecting the AWK-3131A-RTG to the DC power inputs, make sure the DC power source voltage is stable.

Wiring the Relay Contact

The AWK-3131A-RTG has one relay output, which consists of the two contacts of the terminal block on the AWK-3131A-RTG's top panel. Refer to the previous section for detailed instructions on how to connect the wires to the terminal block connector, and how to attach the terminal block connector to the terminal block receptor. These relay contacts are used to indicate user-configured events. The two wires attached to the Relay contacts form an open circuit when a user-configured event is triggered. If a user-configured event does not occur, the relay circuit will be closed.

Wiring the Digital Inputs

The AWK-3131A-RTG has two sets of digital inputs: DI0 and DI1. Each DI comprises two contacts of the 10-pin terminal block connector on the AWK-3131A-RTG's top panel. Refer to the "Wiring the Redundant Power Inputs" section for detailed instructions on how to connect the wires to the terminal block connector, and how to attach the terminal block connector to the terminal block receptor.

Cable Holder Installation (Optional)

You can attach the cable holder to the bottom of the AWK-3131A-RTG to keep cabling neat and avoid accidents that result from untidy cables.

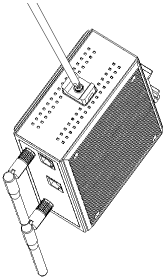

STEP 1:

Screw the cable holder onto the bottom of the AWK-3131A-RTG.

STEP 2:

After mounting the AWK-3131A-RTG and plugging in the LAN cable, tighten the cable along the device and wall.

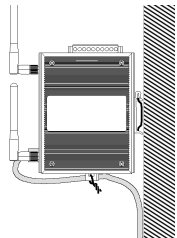
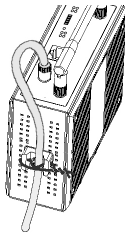
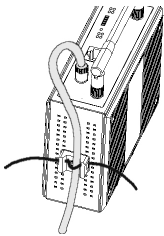

Communication Connections

100BaseFX Fiber Port Connection

The concept behind the SC port and cable is quite straightforward. Suppose you are connecting devices 1 and 2; contrary to electrical signals, optical signals do not need a circuit in order to transmit data. Consequently, one of the optical lines is used to transmit data from device 1 to device 2, and the other optical line is used to transmit data from device 2 to device 1, for full-duplex transmission. Remember to connect the Tx (transmit) port of device 1 to the Rx (receive) port of device 2, and vice versa.

If you make your own cable, we suggest labeling the two sides of the same line with the same letter (A-to-A and B-B, as illustrated below, or (A1-to-A1, B1-to-B2, etc.).

SC-Port Pinouts

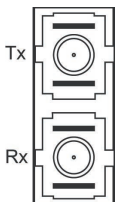

SC-Port to SC-Port Cable Wiring

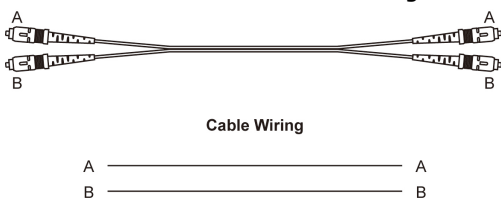

ATTENTION

This is a Class 1 Laser/LED product. To avoid causing serious damage to your eyes, do not stare directly into the laser beam.

10/100BaseT(X) Ethernet Port Connection

All AWK-3131A-M12-RTG have a 10/100BaseT(X) Ethernet port (4-pin shielded M12 connector with D coding). The 10/100TX port located on the AWK-3131A-M12-RTG's front panel is used to connect to Ethernet-enabled devices. Most users configure this port for Auto MDI/MDI-X mode, in which case the port's pinouts are adjusted automatically depending on the type of Ethernet cable used (straight-through or cross-over), and the type of device (NIC-type or HUB/Switch-type) connected to the port.

Pinouts for the 10/100BaseT(X) Port

PIN	TX
1	TD+
2	RD+
3	TD-
4	RD-

The diagram shows a circular 4-pin M12 connector with pins numbered 1, 2, 3, and 4. Pin 1 is at the bottom, pin 2 is at the top, pin 3 is at the top-right, and pin 4 is at the bottom-right.

Housing: shield

RS-232 Connection

The AWK-3131A-RTG has one RS-232 (8-pin RJ45) console port located on the front panel. Use either an RJ45-to-DB9 or RJ45-to-DB25 cable to connect the AWK-3131A-RTG's console port to your PC's COM port. You may then use a console terminal program to access the AWK-3131A-RTG for console configuration.

Console Pinouts for 10-pin or 8-pin RJ45

10-Pin Connector	Description	8-Pin Connector
1	-	-
2	DSR	1
3	RTS	2
4	GND	3
5	TxD	4
6	RxD	5
7	DCD	6
8	CTS	7
9	DTR	8
10	-	-

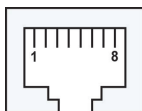

ATTENTION

For railway rolling stock applications, the AWK-3131A-RTG must use a galvanically isolated power supply that is compliant with the EN 50155 standard.

LED Indicators

The front panel of the Moxa AWK-3131A-RTG contains several LED indicators. The function of each LED is described in the table below.

LED	Color	State	Description
PWR1	Green	On	Power is being supplied from power input 1.
		Off	Power is not being supplied from power input 1.
PWR2	Green	On	Power is being supplied from power input 2.
		Off	Power is not being supplied from power input 2.
PoE (AWK-3131 A-M12-RTG only)	Amber	On	Power is being supplied via PoE.
		Off	Power is not being supplied via PoE.
FAULT	Red	Blinking (slow at 1-second intervals)	Cannot get an IP address from the DHCP server
		Blinking (fast at 0.5-second intervals)	IP address conflict
		Off	No errors
STATE	Green/Red	Green	System startup is complete and the system is in operation
		Green (blinking at 1-second intervals)	The AWK has been located by the Wireless Search Utility.
		Red	Boot up error

LED	Color	State	Description
SIGNAL (5 LEDs)	Green	On	Signal level
		Off	(for Client and Client-Router mode only)
CLIENT MODE	Green	On	The AWK is functioning in Client or Client-Router Mode.
		Off	The AWK is not functioning in Client or Client-Router Mode.
WLAN	Amber	On	WLAN is in use.
		Off	WLAN is not in use.
LAN/ 100M*	Green	On	100 Mbps link is active .
		Blinking	Data is being transmitted at 100 Mbps.
		Off	100 Mbps link is inactive .

*100M applies to the AWK-3131A-SSC-RTG model only.

Specifications

Input Current	0.6 A @ 12 VDC; 0.15 A @ 48 VDC
Input Voltage	12 to 48 VDC, redundant dual DC power inputs or 48 VDC Power-over-Ethernet Plus (IEEE 802.3af compliant)
Power Consumption	7.2 W
Operating Temperature	Standard Models: -25 to 60°C (-13 to 140°F) Wide Temp. Models: -40 to 75°C (-40 to 167°F)
Storage Temperature	-40 to 85°C (-40 to 185°F)



ATTENTION

The AWK-3131A-SCC-RTG is an industrial wireless device and hence the antenna should be installed such that it is located at least 10 cm away from the SC fiber port to ensure proper working of the fiber port. The AWK-3131A-RTG is **NOT** a portable mobile device and should be located at least 20 cm away from the human body.

The AWK-3131A-RTG is **NOT** designed for the general public. To establish a wireless network safely using the AWK-3131A-RTG, a well-trained technician should be consulted for installation.



ATTENTION

Use the antennas correctly: 2.4 GHz antennas are needed when the AWK-3131A-RTG operates in an IEEE 802.11b/g/n wireless environment. 5 GHz antennas are needed for an IEEE 802.11a/n environment. Make sure your antenna is installed in a safe area that is covered by a lightning protection or surge arrest system.