

# **MC-1100 Series Hardware User's Manual**

---

**Version 4.1, September 2021**

[www.moxa.com/product](http://www.moxa.com/product)

**MOXA<sup>®</sup>**

© 2021 Moxa Inc., All rights reserved.

# MC-1100 Series Hardware User's Manual

The software described in this manual is furnished under a license agreement and may be used only in accordance with the terms of that agreement.

## Copyright Notice

© 2021 Moxa Inc., All rights reserved.

## Trademarks

The MOXA logo is a registered trademark of Moxa Inc.  
All other trademarks or registered marks in this manual belong to their respective manufacturers.

## Disclaimer

Information in this document is subject to change without notice and does not represent a commitment on the part of Moxa.

Moxa provides this document as is, without warranty of any kind, either expressed or implied, including, but not limited to, its particular purpose. Moxa reserves the right to make improvements and/or changes to this manual, or to the products and/or the programs described in this manual, at any time.

Information provided in this manual is intended to be accurate and reliable. However, Moxa assumes no responsibility for its use, or for any infringements on the rights of third parties that may result from its use.

This product might include unintentional technical or typographical errors. Changes are periodically made to the information herein to correct such errors, and these changes are incorporated into new editions of the publication.

## Technical Support Contact Information

[www.moxa.com/support](http://www.moxa.com/support)

### **Moxa Americas**

Toll-free: 1-888-669-2872  
Tel: +1-714-528-6777  
Fax: +1-714-528-6778

### **Moxa Europe**

Tel: +49-89-3 70 03 99-0  
Fax: +49-89-3 70 03 99-99

### **Moxa India**

Tel: +91-80-4172-9088  
Fax: +91-80-4132-1045

### **Moxa China (Shanghai office)**

Toll-free: 800-820-5036  
Tel: +86-21-5258-9955  
Fax: +86-21-5258-5505

### **Moxa Asia-Pacific**

Tel: +886-2-8919-1230  
Fax: +886-2-8919-1231

# Table of Contents

<b>1. Introduction</b>	<b>1-1</b>
Package Checklist	1-2
Product Features	1-2
MC-1100 Hardware Specifications	1-2
Hardware Block Diagram	1-3
<b>2. Hardware Introduction</b>	<b>2-1</b>
Appearance	2-2
MC-1111	2-2
MC-1121	2-3
MC-1112	2-4
MC-1122	2-5
Dimensions in mm (inch)	2-6
MC-1111	2-6
MC-1121	2-7
MC-1112	2-8
MC-1122	2-9
LED Indicators	2-10
<b>3. Hardware Connection Description</b>	<b>3-1</b>
Installing a Wireless Module	3-2
Installing the MC-1100	3-5
Wiring Requirements	3-7
Connecting the Power	3-7
Grounding the Unit	3-8
Connecting to a Network	3-9
Connecting to a Serial Device	3-11
Installing an SDHC/SDXC Card (MC-1111 and MC-1121 Only)	3-13
Connecting to a USB Device	3-14
DI/DO	3-15
RTC Battery Replacement	3-16
<b>4. BIOS Setup</b>	<b>4-1</b>
Entering the BIOS Setup	4-2
Main Information	4-3
Advanced Settings	4-3
Boot Configuration	4-4
PCI Express Configuration	4-4
USB Configuration	4-5
SD Configuration (MC-1111 and MC-1121 Only)	4-6
Miscellaneous Configuration	4-7
SATA Configuration	4-8
Console Redirection	4-9
Hardware Monitor	4-10
Smart Recovery Info	4-10
Security Settings	4-11
Set Supervisor Password	4-11
Power Settings	4-12
Wake on LAN	4-12
Auto Wake on S5	4-13
Power State 2 for VCC & VNN	4-14
Boot Settings	4-14
Boot Type	4-14
PXE Boot to LAN	4-14
PXE Boot capability	4-14
Add Boot Options	4-15
USB Boot	4-15
Boot Delay Time	4-15
Automatic Failover	4-15
Boot Order Priority	4-15
Legacy	4-15
EFI	4-16
Exit Settings	4-17
Exit Saving Changes	4-17
Save Change Without Exiting	4-17
Exit Discarding Changes	4-17
Load Optimal Defaults	4-17
Load Custom Defaults	4-17
Save Custom Defaults	4-18
Discard Changes	4-18

Upgrading the BIOS .....	4-18
<b>A. Regulatory Approval Statement .....</b>	<b>A-1</b>
<b>B. Configuring the Serial Interface .....</b>	<b>B-1</b>
Overview .....	B-2
Configuring the Serial Interface Mode.....	B-2
<b>C. Examples.....</b>	<b>C-1</b>
Serial Interface .....	C-2
Digital Input/Output.....	C-3
Watchdog .....	C-5
Power Control .....	C-5
<b>D. Telit LE910 Module for the SMS Function .....</b>	<b>D-1</b>
Setting Up the Test Environment .....	D-2
Prerequisites.....	D-2
Setting Up the Test System .....	D-2
Using MxTerm to Test the SMS Function .....	D-4
Using a Sample Program to Test the SMS Function .....	D-6

## Introduction

---

Moxa's MC-1100 Series DIN-rail mountable, fanless, x86 embedded computers are based on the Intel® Atom™ E3800 Series processor, feature the most reliable I/O design to maximize connectivity, and support wireless modules (Wi-Fi/3G/LTE), making them suitable for a diverse range of communication applications.

With a wide operating temperature range (-40 to 70°C) and compliance with safety, EMI, and EMS standards, the MC-1100 Series of computers are ideal for intelligent computing and communication solutions operating in critical environments, including marine communication, oil & gas field site monitoring, and transportation.

The MC-1100 Series supports "Moxa Hardware Monitoring" for device I/O status monitoring and alerts, system temperature monitoring and alerts, and system power management. The ability to closely monitor a system status makes it easier to recover from errors and provides the most reliable platform for your applications.

The following topics are covered in this chapter:

- ❑ **Package Checklist**
- ❑ **Product Features**
- ❑ **MC-1100 Hardware Specifications**
- ❑ **Hardware Block Diagram**

## Package Checklist

- MC-1100 embedded computer
- Terminal block to power jack converter
- DIN-rail mounting kit
- Quick installation guide (printed)
- Warranty card

**NOTE:** Please notify your sales representative if any of the above items are missing or damaged.

## Product Features

MC-1100 embedded computers support the following features:

- Intel Atom Quad-core E3845 processor
- -40 to 70°C system operating temperature
- One mini-PCIe socket for wireless modules: Wi-Fi, 3G, LTE, GPS, and Bluetooth
- Variety of interfaces: Up to 2 serial ports, 4 Ethernet LAN ports, 4 DIs, 4 DOs, SD slot, 2 USB ports, VGA port, display port, wireless
- Certified for mission-critical environments: IEC-60945, DNV, UL C1D2, ATEX/ IECEx
- Windows 7 Embedded and Debian 8 platform support
- Moxa Proactive Monitoring utility for system hardware health monitoring
- Moxa Smart Recovery utility to recover system from boot failure (W7E only)

## MC-1100 Hardware Specifications

The latest specifications for Moxa's products can be found at <https://www.moxa.com>.

# Hardware Block Diagram

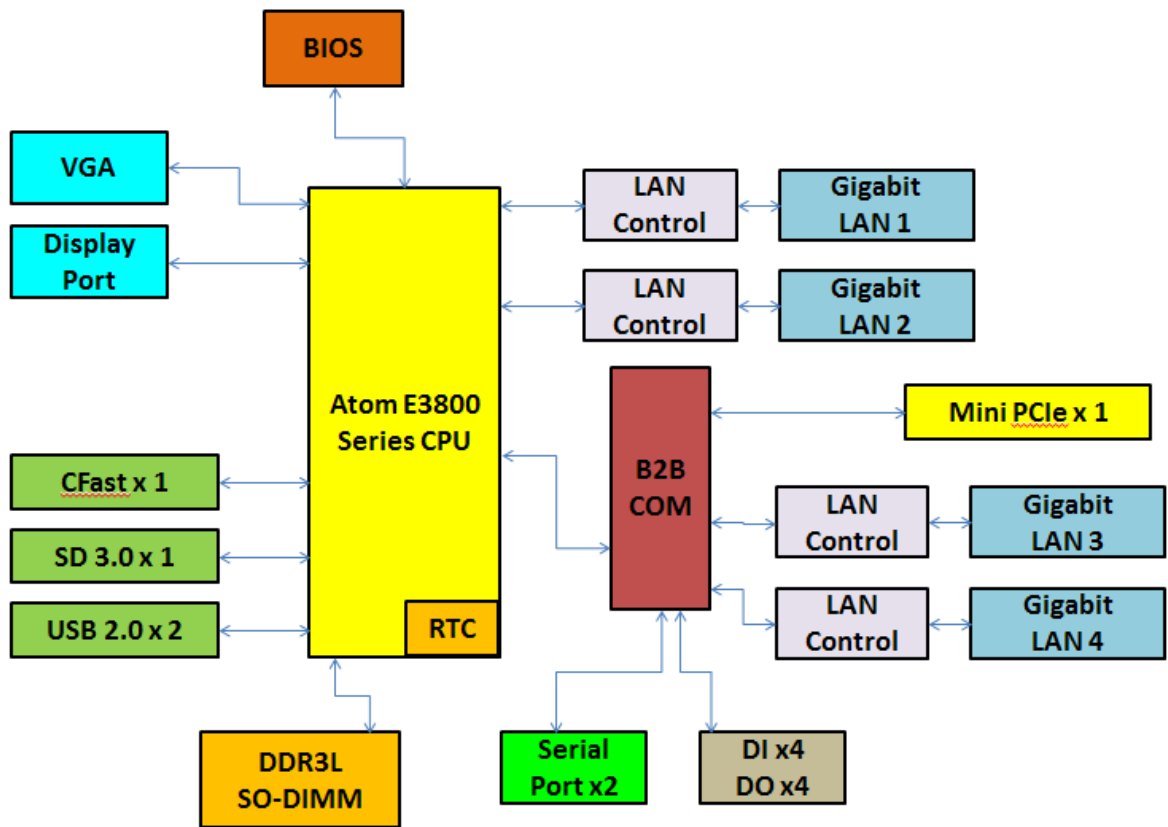

## Hardware Introduction

---

The MC-1100 Series embedded computers are compact, well-designed, and rugged enough for industrial applications. LED indicators help you monitor performance and identify trouble spots, multiple serial ports allow you to connect different devices for wireless operation, and the reliable and stable hardware platform lets you devote your attention to developing your applications.

The following topics are covered in this chapter:



# Appearance

## MC-1111

Top View

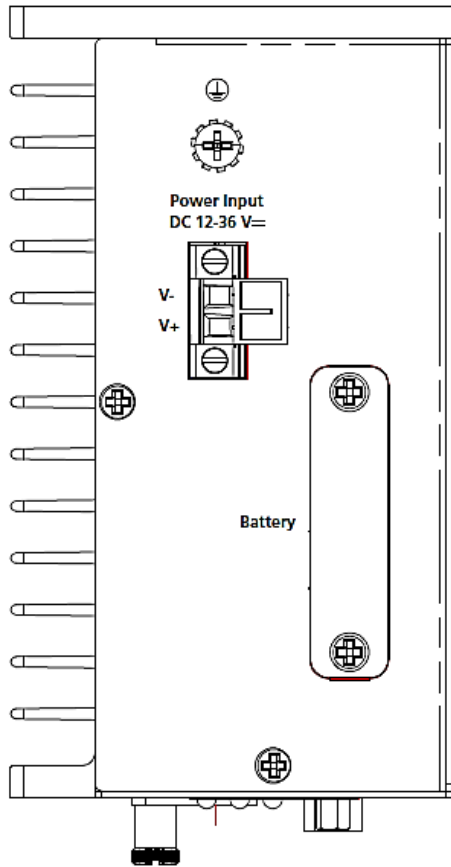

Front View

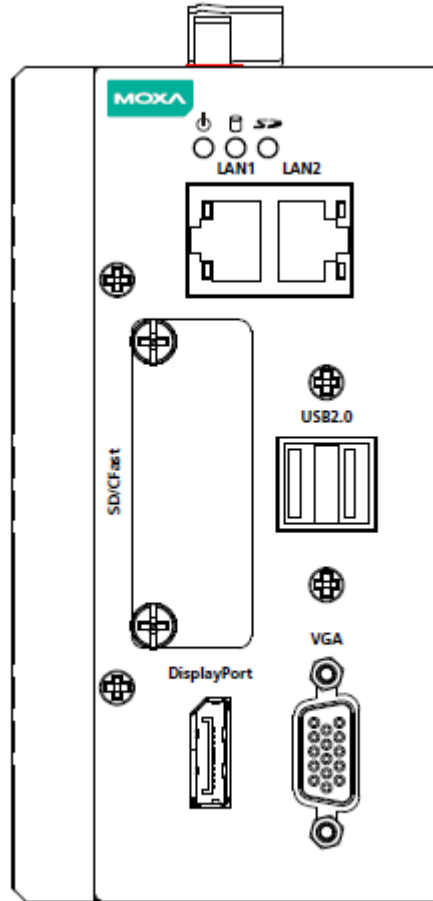

# MC-1121

**Top View**

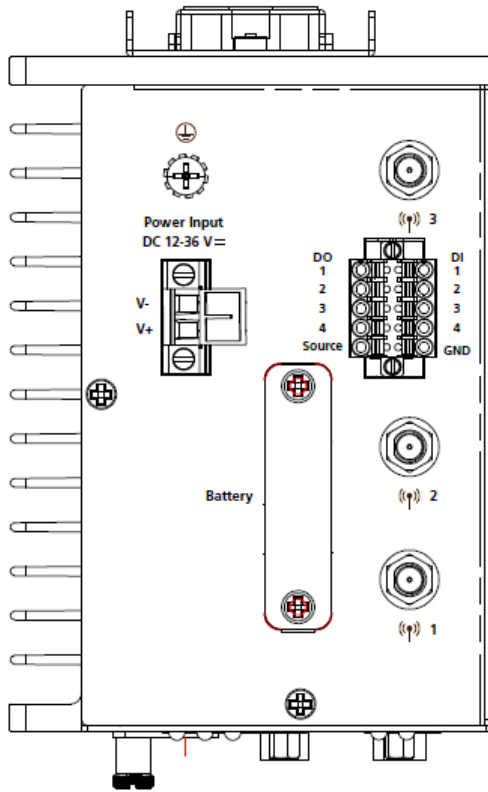

**Front View**

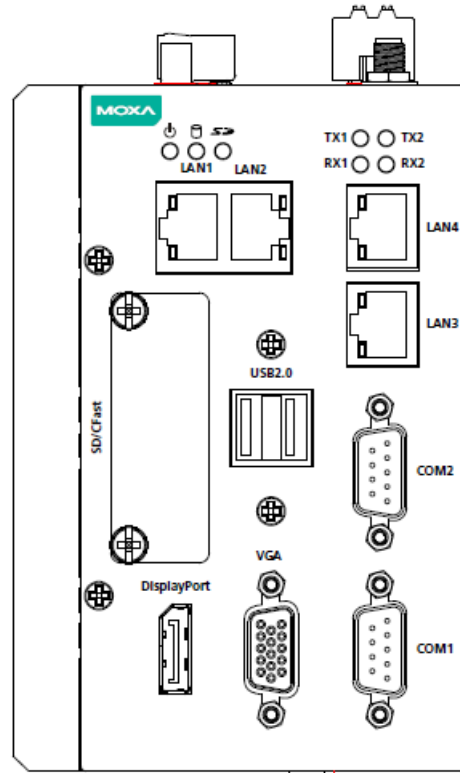

**Rear View**

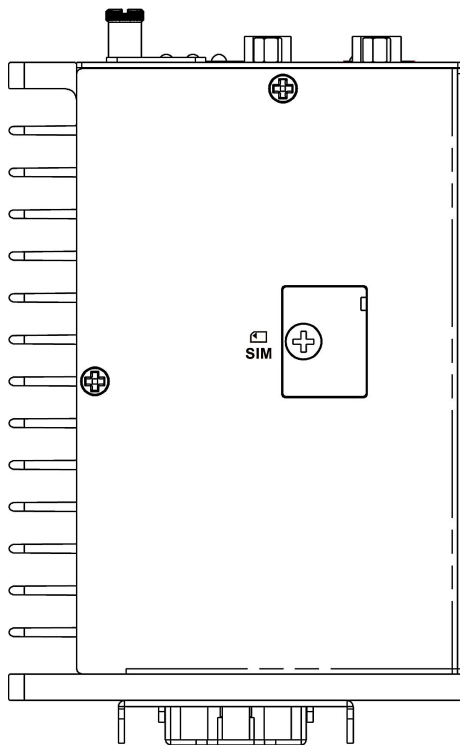

# MC-1112

**Top View**

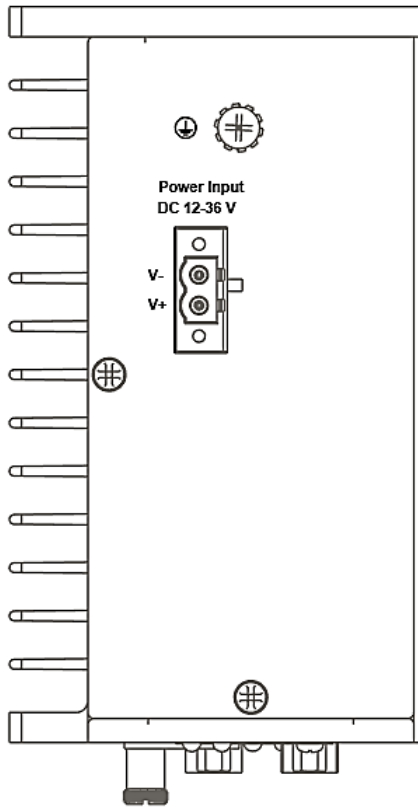

**Front View**

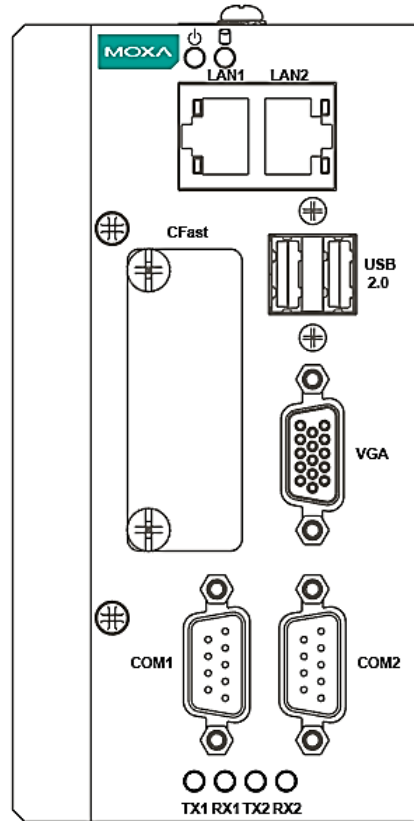

**Rear View**

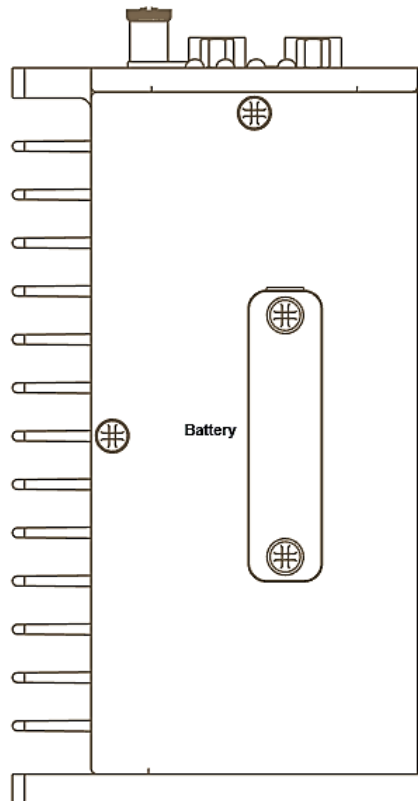

# MC-1122

**Top View**

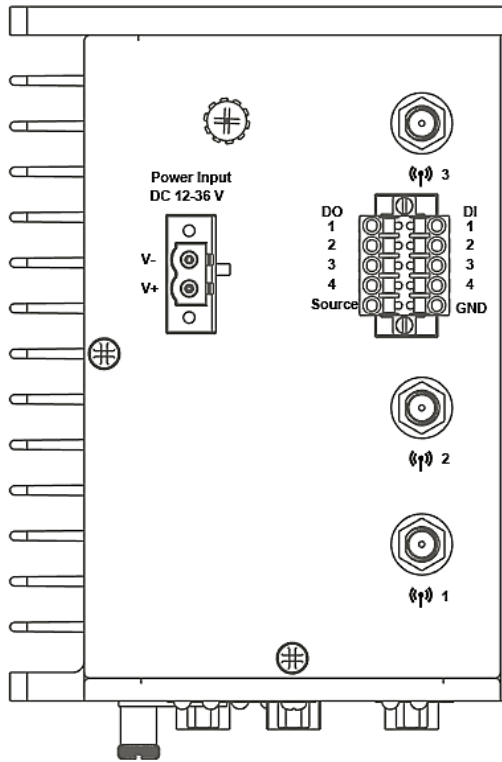

**Front View**

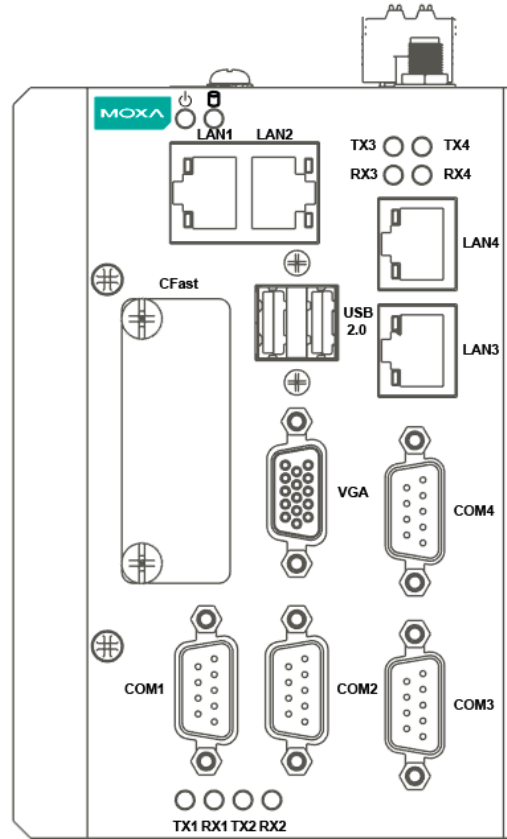

**Rear View**

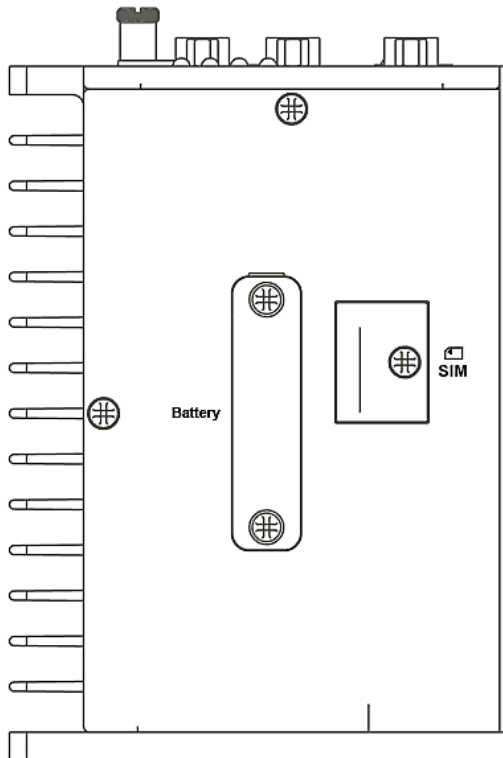

# Dimensions in mm (inch)

## MC-1111

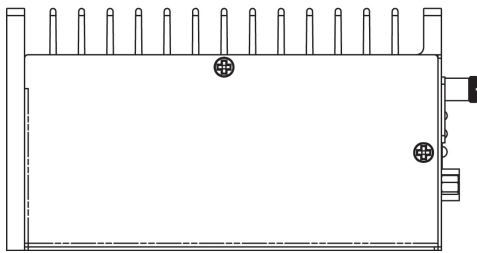
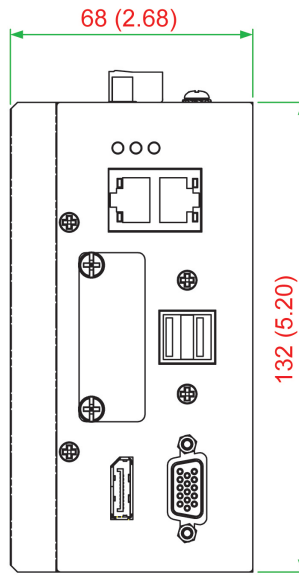
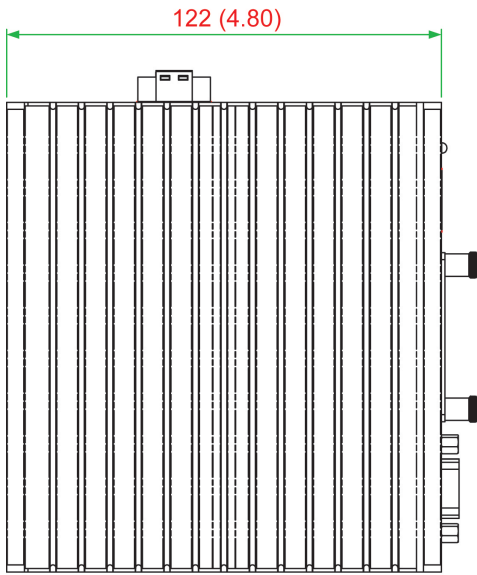
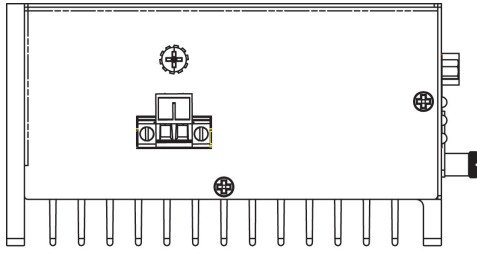

# MC-1121

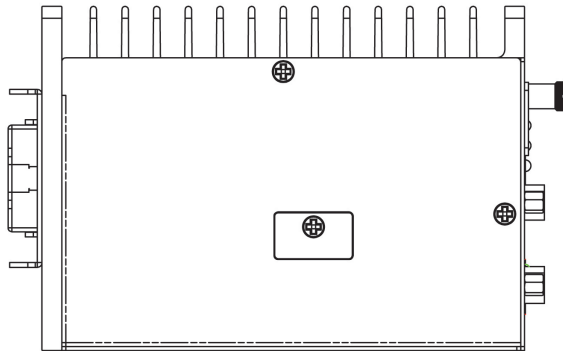
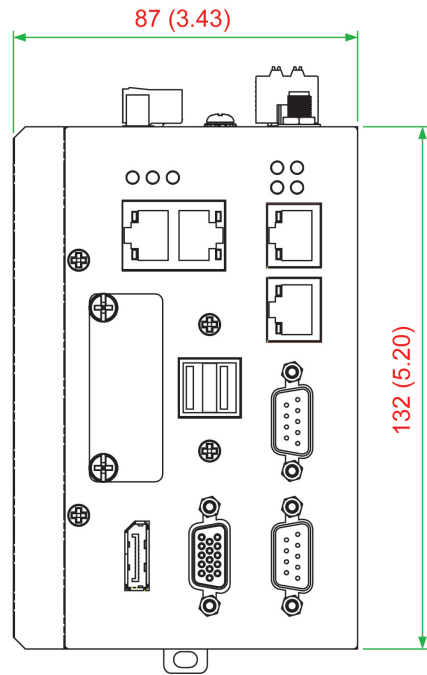
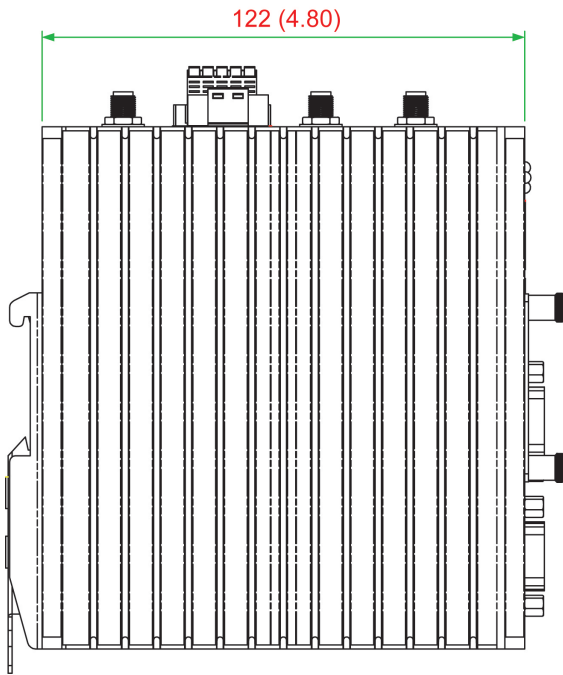
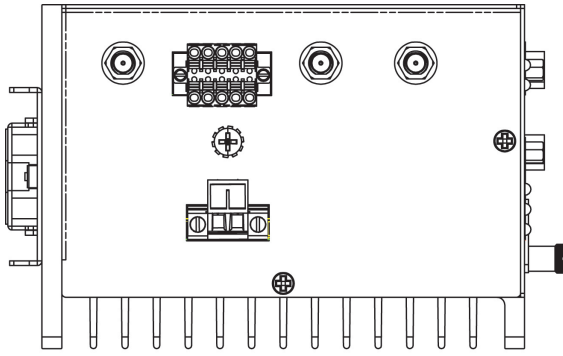

# MC-1112

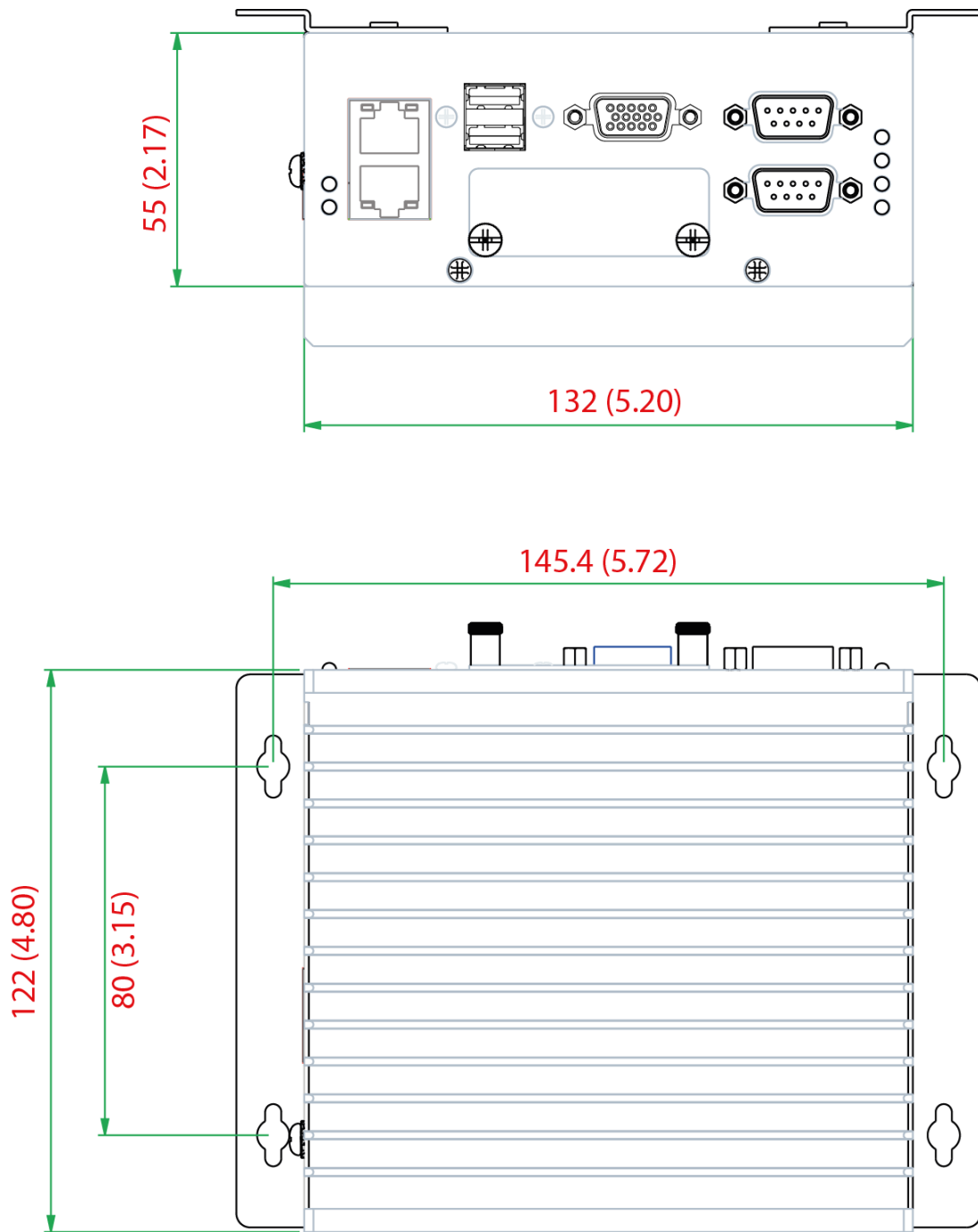

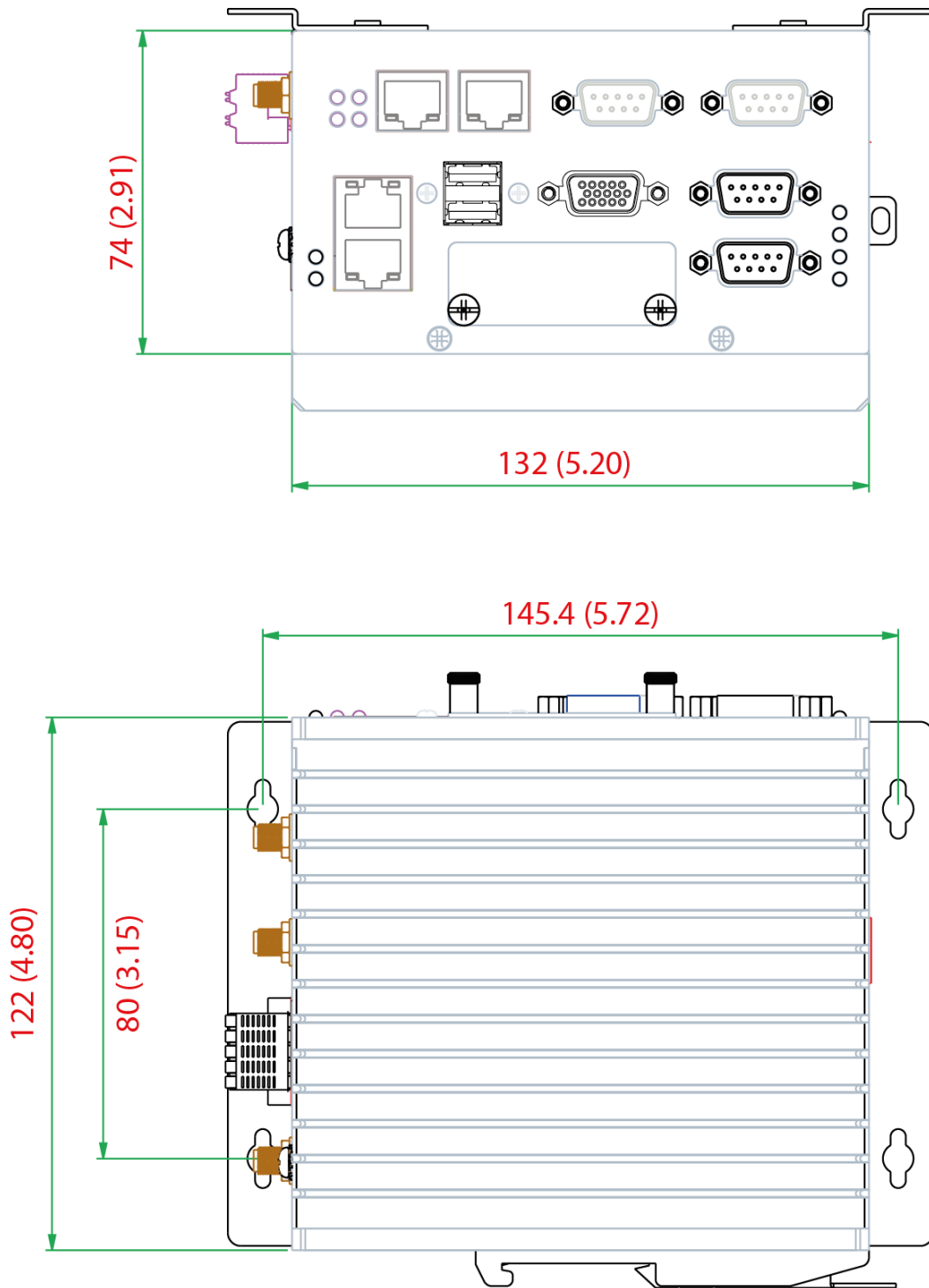

# MC-1122





## LED Indicators

LED Name	Status	Function
Power 	Green	Power is on and computer is function normally.
	Off	Power is off.
Storage 1 (CFast) 	Yellow	Blinking: Data is being transmitted.
	Off	No data transmission.
Storage 2 (SD) (MC-1111 and MC-1121 Series only) 	Yellow	Blinking: Data is being transmitted.
	Off	No data transmission.
LAN 1/2/3/4 (LAN 3/4 is available only on the MC-1121 and MC-1122 Series)	Green	100 Mbps Ethernet link. Blinking: Data is being transmitted.
	Yellow	1000 Mbps Ethernet link. Blinking: Data is being transmitted.
	Off	10 Mbps Ethernet link or LAN is not connected.
Tx 1/2/3/4	Green	Blinking: Data is being transmitted.
	Off	Not connected.
Rx 1/2/3/4	Yellow	Blinking: Data is being transmitted.
	Off	Not connected.

## Hardware Connection Description

---

In this chapter, we show how to connect the embedded computers to the network and to various devices.

The following topics are covered in this chapter:

# Installing a Wireless Module

The MC-1121 and MC-1122 models are provided with one mini-PCIe socket. To install a wireless module (Wi-Fi, 3G, LTE, GPS, or Bluetooth), do the following:

**STEP1:** Loosen the six screws on the right panel and two screws on the bottom panel of your computer.

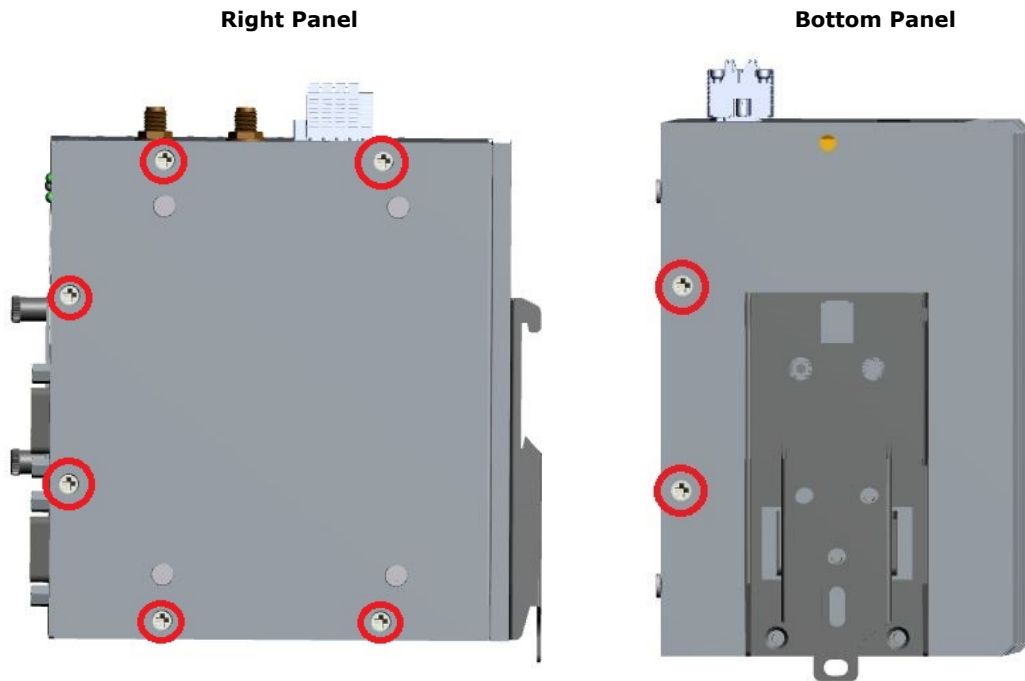

**STEP2:** Remove the right cover to expose the mini-PCIe socket.



**STEP 3:** Insert the wireless module card into the socket at an angle.

**STEP 4:** Push down the wireless module card and fasten two screws on to the card to secure it in place.

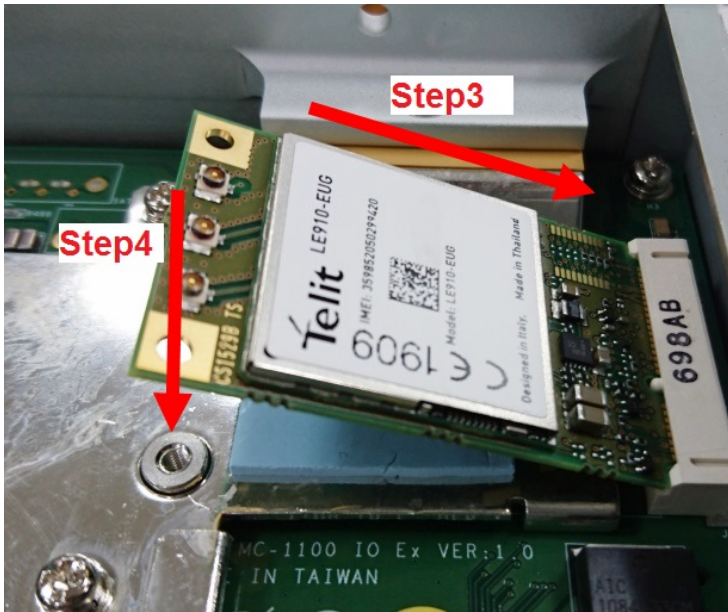

**STEP 5:** Connect the SMA cable to the connector on the wireless module card installed.



**Package name: Cellular-LTE-EU(LE910)**

The available connectors are:

- Main RF antenna (ANT)
- RX Diversity Antenna (DIV)
- GNSS Antenna (GPS)

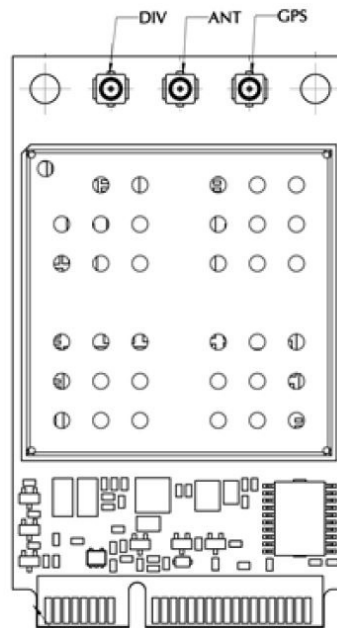

**Package name:**  
**Cellular-LTE(L201) for North America/**  
**Cellular-LTE(L210) for EMEA and APAC**

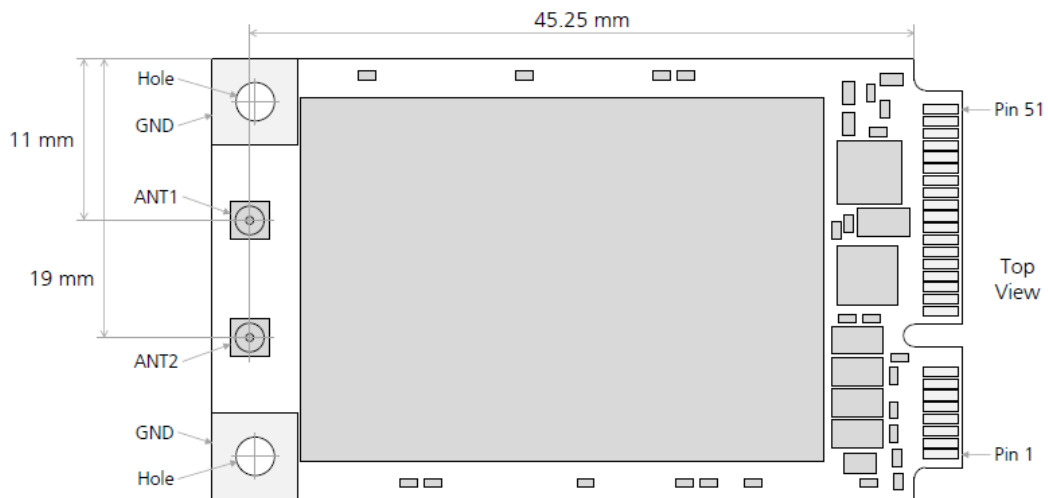

The available connectors are:

- ANT1: Main RF Antenna
- ANT2: RX Diversity Antenna

	<b>Cellular-LTE(L201)</b>	<b>Cellular-LTE(L210)</b>
<b>Area</b>	North America	EMEA and APAC
<b>LTE Bands</b>	2, 4, 5, 13, 17	1, 3, 5, 7, 8, 20
<b>UMTS Bands</b>	850, 1900	850, 900, 1900, 2100
<b>Data Rates</b>	Cat 4 (150 Mbit/s DL, 50 Mbit/s UL)	Cat 4 (150 Mbit/s DL, 50 Mbit/s UL)
<b>MIMO</b>	2x2	2x2

**STEP 6:** Replace the right cover.

You can also purchase external 3G, 4G, and Wi-Fi antennas from Moxa. Please contact a Moxa sales representative for information.

After installing the wireless modules and external wireless antennas, the computer should appear as shown here.



## Installing the MC-1100

### DIN-rail Mounting

The MC-1100 comes with a DIN-rail mounting kit for installing the computer on a DIN rail.

#### **Installation:**

##### **STEP 1:**

Use 4 screws to attach the DIN-rail mounting bracket to the MC-1100's rear panel and tighten the screws to secure the bracket.

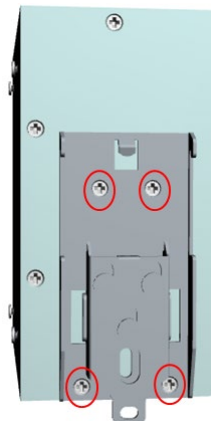

##### **STEP 2:**

Insert the upper lip of the DIN rail into the DIN-rail mounting kit.

##### **STEP 3:**

Press the MC-1100 towards the DIN rail until it snaps into place.

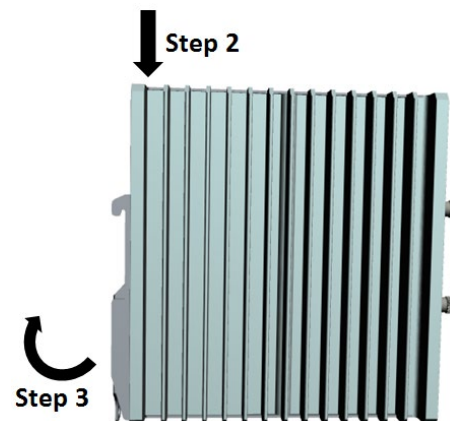

**Removal:**

**STEP 1:**

To unmount the MC-1100, pull down the latch provided at the base of the mounting kit with a screwdriver.

**STEPS 2:**

Slightly pull the MC-1100 forward and lift up to detach it from the DIN rail.

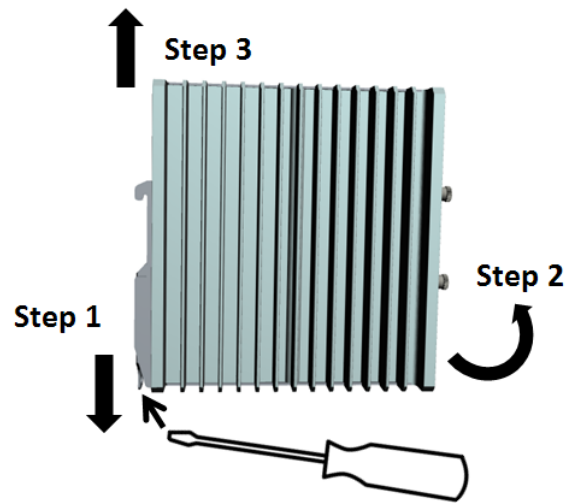

**Wall or Cabinet Mounting (DNV)**

Use the optional wall-mounting kit to install the MC-1100 on to a wall.

**NOTE** The wall mounting kit can be purchased separately.

**STEP 1:**

Attach the wall-mounting brackets to the rear side of the MC-1100 by using two screws per bracket.

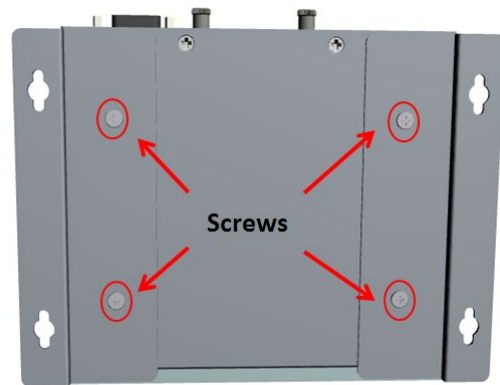

**STEP 2:**

Use four screws per side on the wall-mounting bracket to attach the MC-1100 to a wall or cabinet.

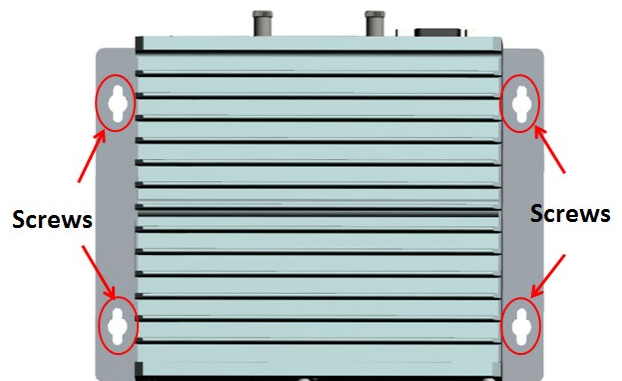

# Wiring Requirements

In this section, we describe how to connect serial devices to the MC-1100 embedded computer. Be sure to read and follow these common safety precautions before proceeding with the installation of any electronic device:

- Use separate paths to route wiring for power and devices. If power wiring and device wiring paths must cross, make sure the wires are perpendicular at the crossing point.
  - NOTE:** Do not run signal or communication wiring together with power wiring in the same wire conduit. To avoid interference, wires with different signal characteristics should be routed separately.
- Use the type of signal transmitted through a wire to determine which wires should be kept separate. The rule of thumb is that wiring that shares similar electrical characteristics can be bundled together.
- Keep input wiring and output wiring separated.
- For future reference, you should label the wiring used for all of your devices.



## ATTENTION

### Safety First!

Be sure to disconnect the power cord before installing and/or wiring your MC-1100.

### Wiring Caution!

Calculate the maximum possible current in each power wire and common wire. Observe all electrical codes dictating the maximum current allowable for each wire size. If the current goes above the maximum ratings, the wiring could overheat, causing serious damage to your equipment.

### Temperature Caution!

Be careful when handling the unit. When the unit is plugged in, the internal components generate heat, and consequently the outer casing may feel hot to the touch.

## Connecting the Power

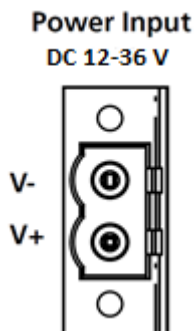

To power on the MC-1100, connect the “terminal block to power jack converter” to the MC-1100’s DC terminal block (located on the left side panel), and then connect the power adapter. The system is automatically turned on when the power is plugged in. If it doesn't turn on automatically, press the Power Button to turn on the computer. Note that the Shielded Ground wire should be connected to the top pin of the terminal block. It takes about 30 seconds for the system to boot up. Once the system is ready, the Power LED will light up.



# Grounding the Unit

Grounding and wire routing help limit the effects of noise due to electromagnetic interference (EMI). Run the ground connection from the grounding screw (M4) to the grounding surface prior to connecting the power.

**MC-1111**

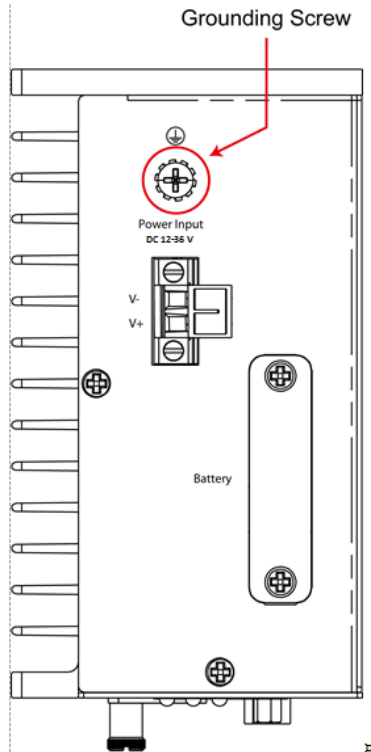

**MC-1112**

**MC-1121**

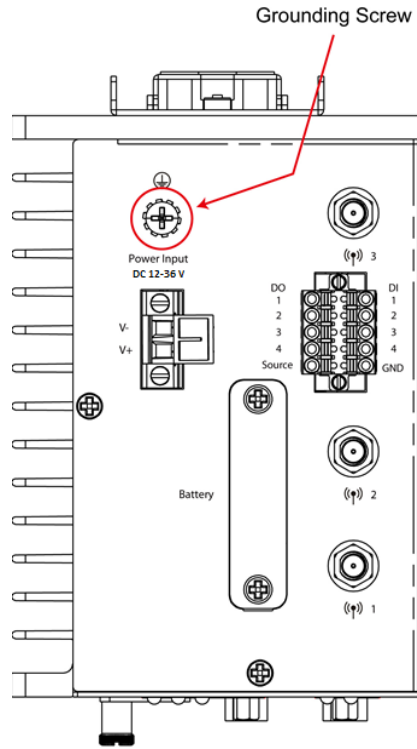

**MC-1122**

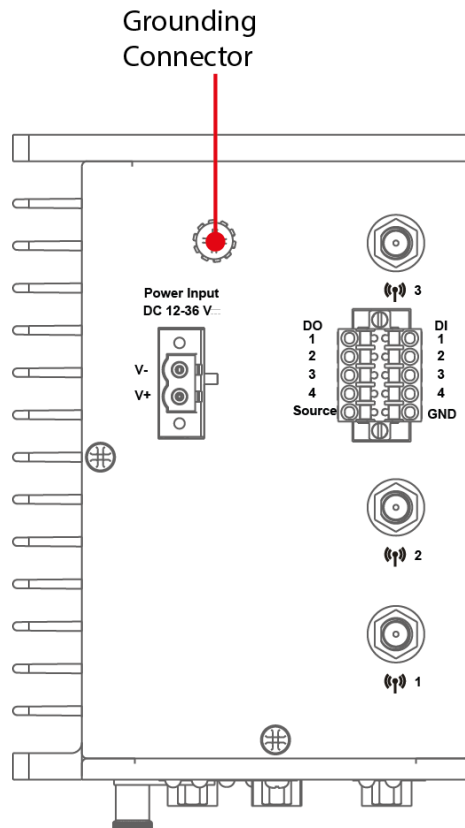

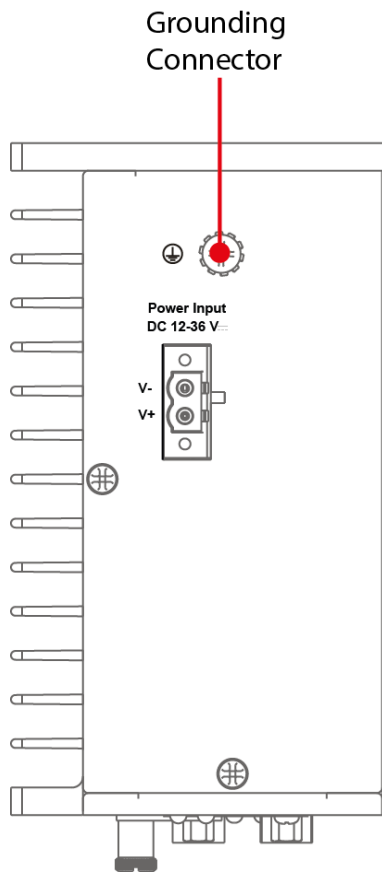

## Connecting to a Network

To connect the MC-1100 computer to a network, connect a network cable to the embedded computer's Ethernet port and connect the other end of the cable to your Ethernet network. When the cable is properly connected, the LEDs on the embedded computer's Ethernet port turns on to indicate a valid connection.

Two 10/100/1000 Mbps Ethernet ports using RJ45 connectors are located on the front panel of the embedded computer. Refer to the following figures for the location and pin assignments of the Ethernet ports.

**NOTE** The pin assignments for the MC-1100 computer's Ethernet port are shown in the following figure. If you create your own Ethernet cable, make sure that you match the pin assignments on the connector of the Ethernet cable.

MC-1111

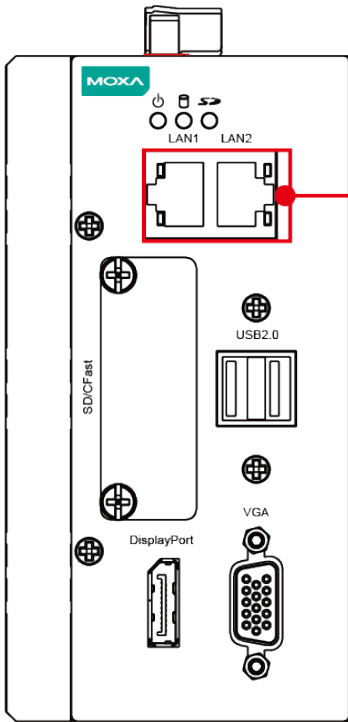

LAN Ports x 2  
(RJ45)

MC-1121

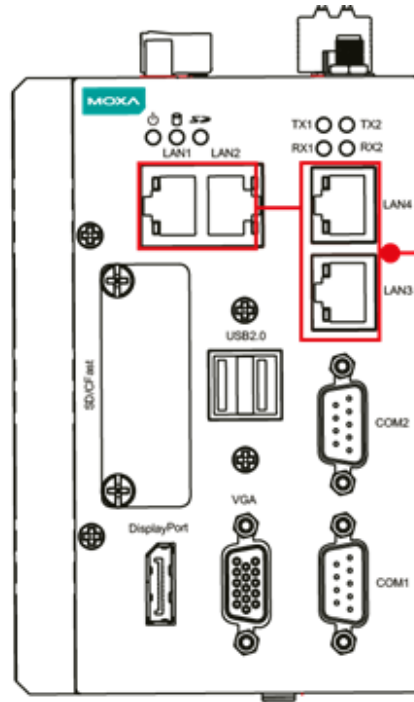

LAN Ports x 4  
(RJ45)

MC-1112

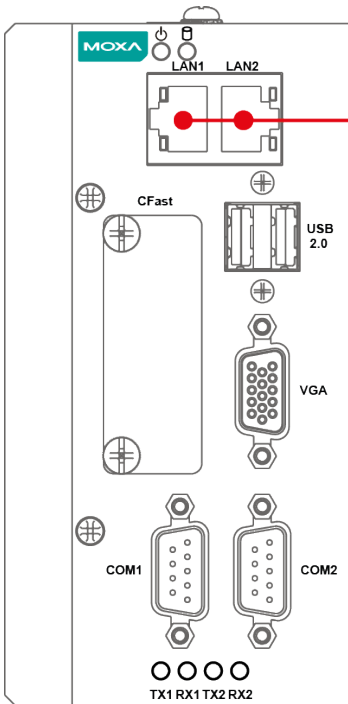

LAN Ports x 2  
(RJ45)

MC-1122

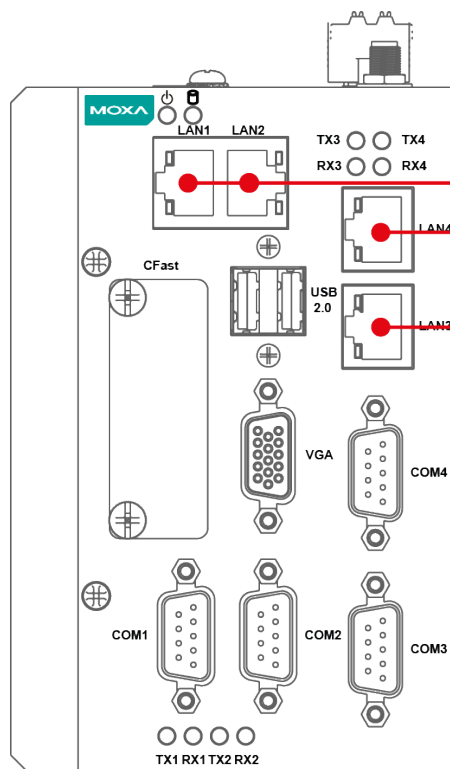

LAN Ports x 4  
(RJ45)

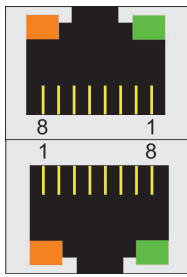

Pin	10/100 Mbps	1000 Mbps
1	ETx+	TRD(0)+
2	ETx-	TRD(0)-
3	ERx+	TRD(1)+
4	-	TRD(2)+
5	-	TRD(2)-
6	ERx-	TRD(1)-
7	-	TRD(3)+
8	-	TRD(3)-

## Connecting to a Serial Device

Use a serial cable to connect your serial device to the embedded computer’s serial port. Serial ports P1 to P2 have male DB9 connectors and can be configured for RS-232, RS-422, or RS-485 communication. For information on serial port configuration, refer to the MC-1100 software manual. The location and pin assignments of the serial ports are shown in the following table:

### MC-1121

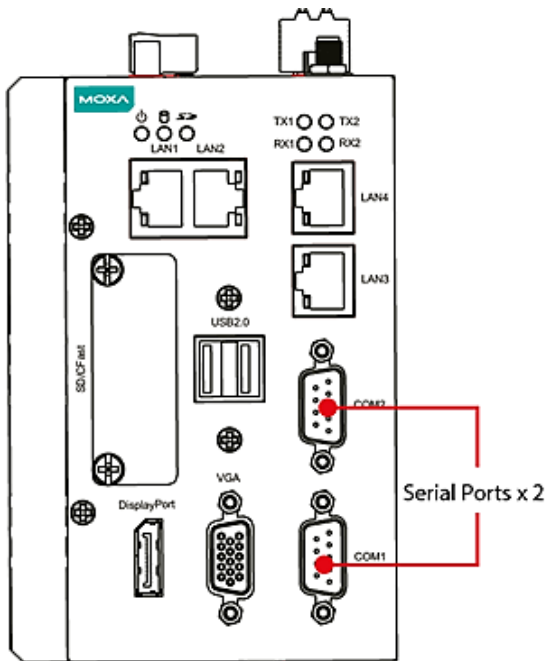

MC-1112

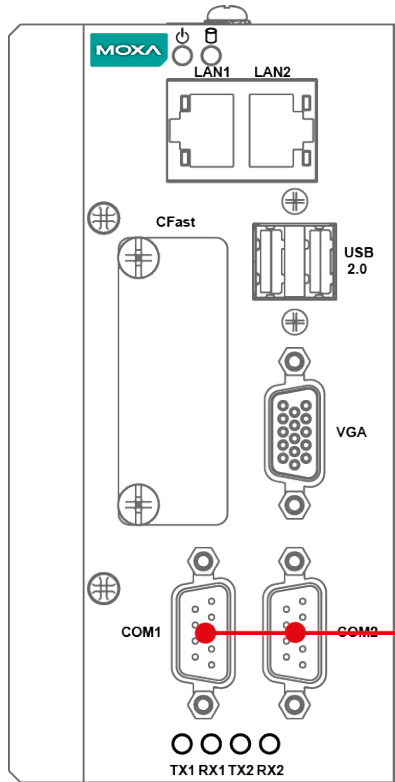

MC-1122

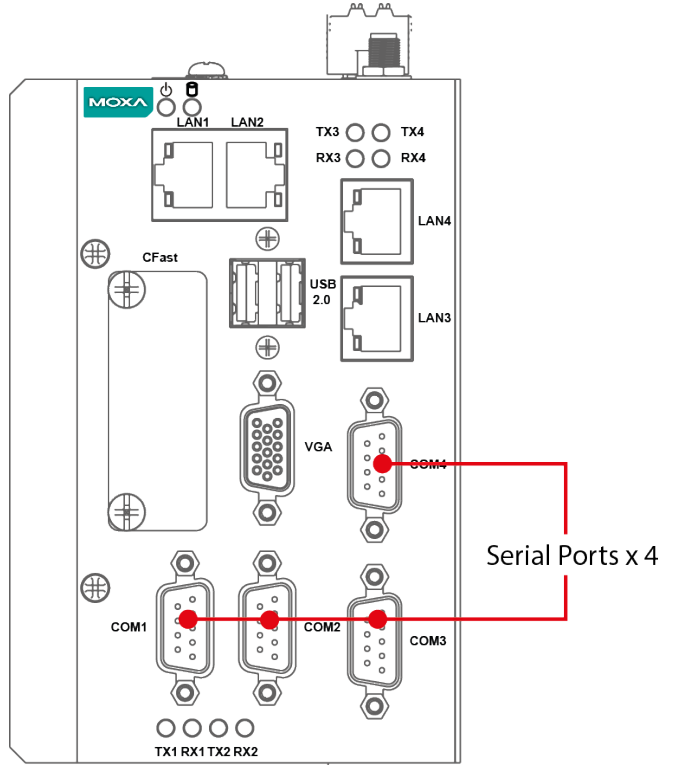

**DB9 Male Port**

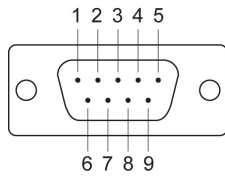

**RS-232/422/485 Pinouts**

Pin	RS-232	RS-422	RS-485 (4-wire)	RS-485 (2-wire)
1	DCD	TxDA(-)	TxDA(-)	-
2	RxD	TxDB(+)	TxDB(+)	-
3	TxD	RxDB(+)	RxDB(+)	DataB(+)
4	DTR	RxDA(-)	RxDA(-)	DataA(-)
5	GND	GND	GND	GND
6	DSR	-	-	-
7	RTS	-	-	-
8	CTS	-	-	-

## Installing an SDHC/SDXC Card (MC-1111 and MC-1121 only)

The MC-1100 has an SD slot for storage expansion. The SD slot allows users to plug in a Secure Digital (SD) memory card, which is compliant with the SD 3.0 standard. To install an SD card, do the following:

1. Disconnect the MC-1100 from its power source.
2. Loosen the two screws on the SD/CFast card slot cover to remove the cover.  
The SD slot is located on the right side of the front panel.

### MC-1111

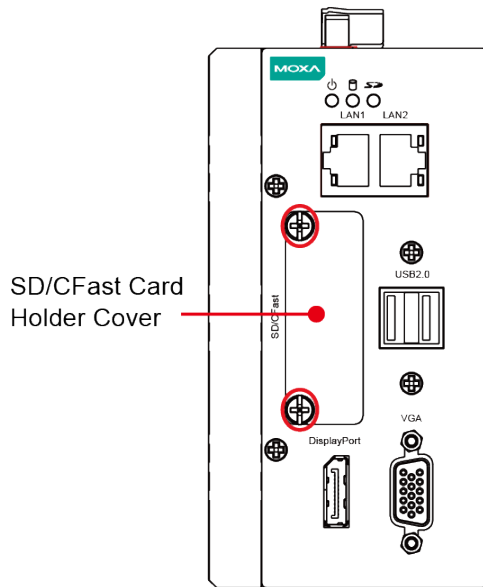

### MC-1121

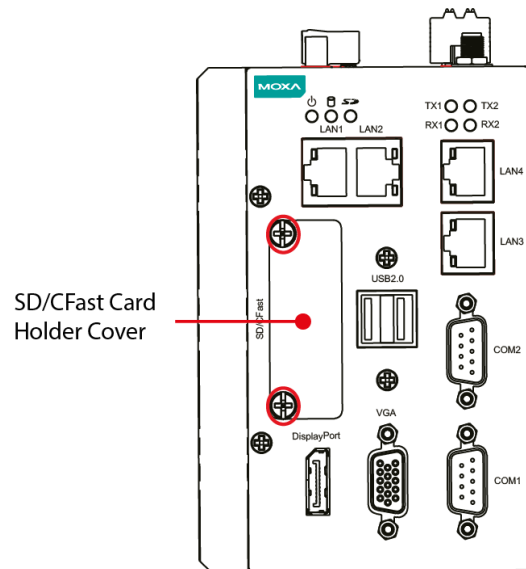

3. Insert the SD card into the slot and gently push it in with a finger until it locks in place.  
To remove the card, gently push it in to release the card and eject it out of the slot.



### ATTENTION

Be sure to properly orient the CFast card when installing it; otherwise, you may not be able to insert the card all the way into the slot.

4. After the SD card is installed correctly, fasten the screws on the SD/CFast card cover.

# Connecting to a USB Device

The MC-1100 has 2 USB 2.0 ports with Type A connectors (rated 5V and 700 mA total for 2 ports; max. 500 mA/port) located on the front panel. The ports support keyboard and mouse and can also be used to connect a flash disk for storing large amounts of data.

The following figures show the locations of the USB ports.

MC-1111

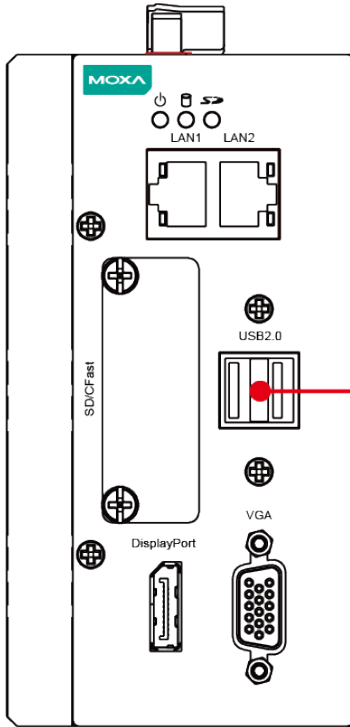

USB Hosts x 2  
(type-A)

MC-1121

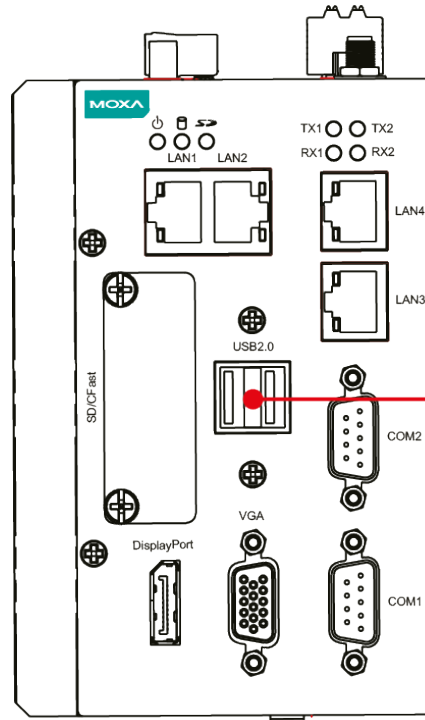

USB Hosts x 2  
(type-A)

MC-1112

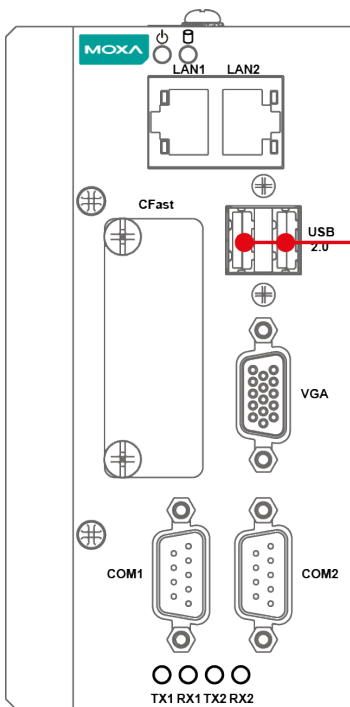

USB 2.0 Hosts x 2

MC-1122

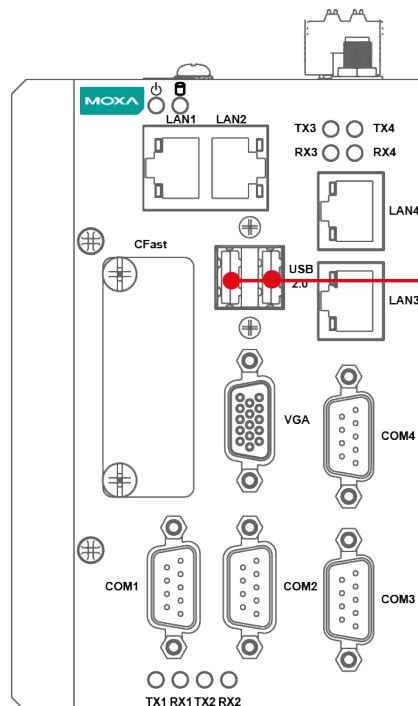

USB 2.0 Hosts x 2

# DI/DO

The MC-1121 comes with a 4-channel digital input and a 4-channel digital output that connect through a terminal block connector. The pin assignments and wiring methods are shown in the diagrams below:

**MC-1121**

DI Channels x 4  
DO Channels x 4

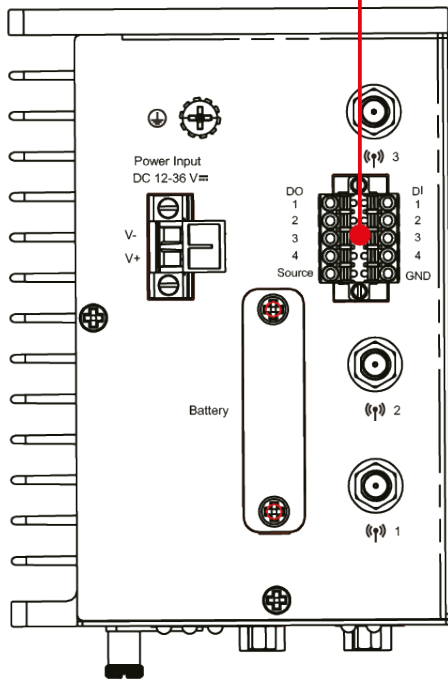

**MC-1122**

DIs x 4/DOs x 4

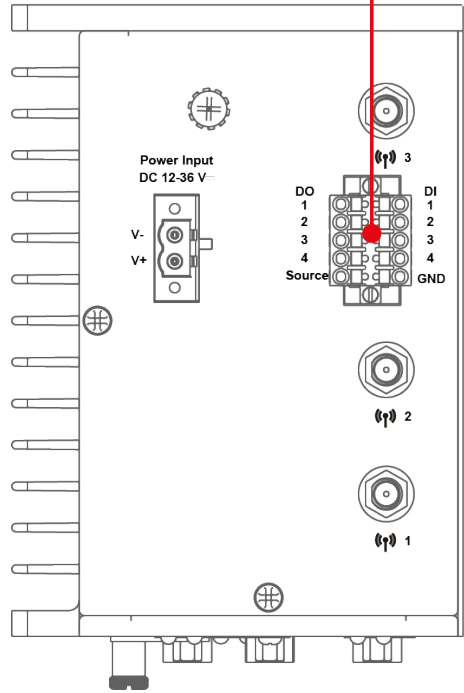

**DI**

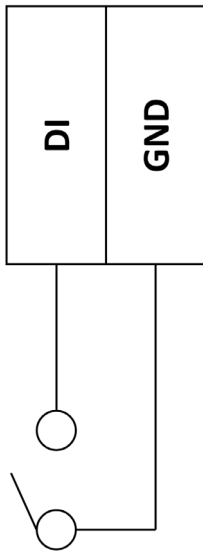

**DO**

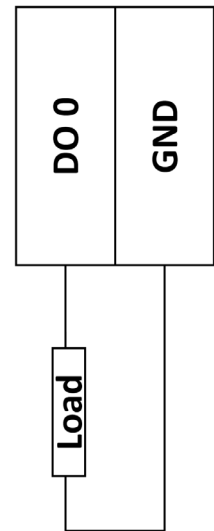



## RTC Battery Replacement

The MC-1100's real-time clock is powered by a lithium battery. We strongly recommend that you do not replace the lithium battery without help from a qualified Moxa support engineer. If you need to change the battery, contact the Moxa RMA service team.

**ATTENTION**

There is a risk of explosion if the battery is replaced by an incorrect type of battery.

**NOTE**

The MC-1100 embedded computer can be customized to support an easy RTC battery replacement function. Please contact your Moxa sales representative for details.

# BIOS Setup

---

In this chapter, we describe the BIOS settings for the MC-1100 embedded computer. The BIOS is a set of input/output control routines for peripherals, which can be used to initialize the basic peripheral settings. The BIOS firmware helps boot the system before the operating system is loaded. The BIOS setup allows the user to modify the system configuration for basic input/output peripherals. All of the configurations are stored in the CMOS RAM, which has a backup battery power in case the computer is not connected to a power source. Consequently, the data stored in the CMOS RAM is retained when the system is rebooted or the power is disconnected.

The following topics are covered in this chapter:

## ❑ Entering the BIOS Setup

### ❑ Main Information

### ❑ Advanced Settings

- Boot Configuration
- PCI Express Configuration
- USB Configuration
- SD Configuration (MC-1111 and MC-1121 Only)
- Miscellaneous Configuration
- SATA Configuration
- Console Redirection
- Hardware Monitor
- Smart Recovery Info

### ❑ Security Settings

- Set Supervisor Password

### ❑ Power Settings

- Wake on LAN
- Auto Wake on S5
- Power State 2 for VCC & VNN

### ❑ Boot Settings

- Boot Type
- PXE Boot to LAN
- PXE Boot capability
- Add Boot Options
- USB Boot
- Boot Delay Time
- Automatic Failover
- Boot Order Priority
- Legacy

### ❑ EFI

## ❑ Exit Settings

- Exit Saving Changes
- Save Change Without Exiting
- Exit Discarding Changes
- Load Optimal Defaults
- Load Custom Defaults
- Save Custom Defaults
- Discard Changes

## ❑ Upgrading the BIOS

# Entering the BIOS Setup

To enter the BIOS setup utility, press the **F2** key while the system is booting up. The main **BIOS Setup** screen appears with the following options:

- **Continue:** Continue to boot up
- **Boot Manager:** Select the device to boot up
- **Boot From File:** Select the UEFI boot up file
- **Setup Utility**

Click **Setup Utility** to enter the **BIOS configuration**.

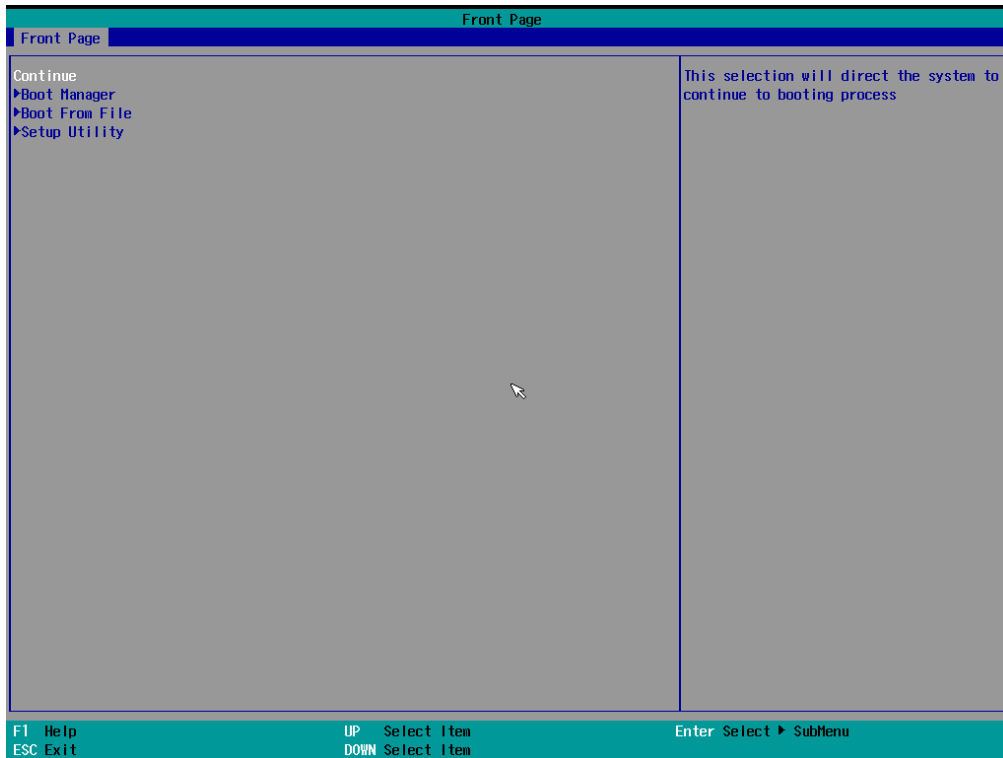

When you click **Setup Utility**, a basic description of each function key is listed at the bottom of the screen. Refer to these descriptions to learn how to use them.

**F1: Help**

**F5/F6: Change Values**

**F9: Setup Defaults**

**F10: Save and Exit**

↑ ↓ : **Select Item**

← → : **Select Menu**

**ESC: Exit**

**ENTER: Select or go to Submenu.**

# Main Information

The main page shows basic system information, such as the model name, BIOS version, and CPU type.

**NOTE** The "Processor Type" varies depending on the product model.

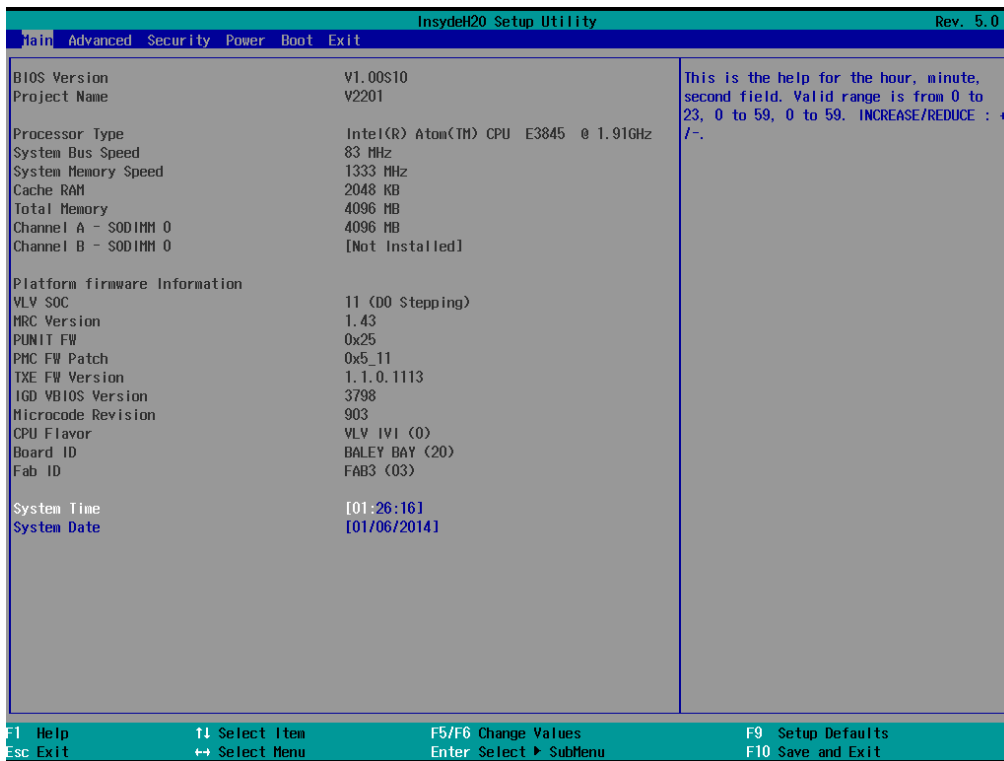

# Advanced Settings

The **Advanced** screen appears when you select "Advanced" from the main menu.

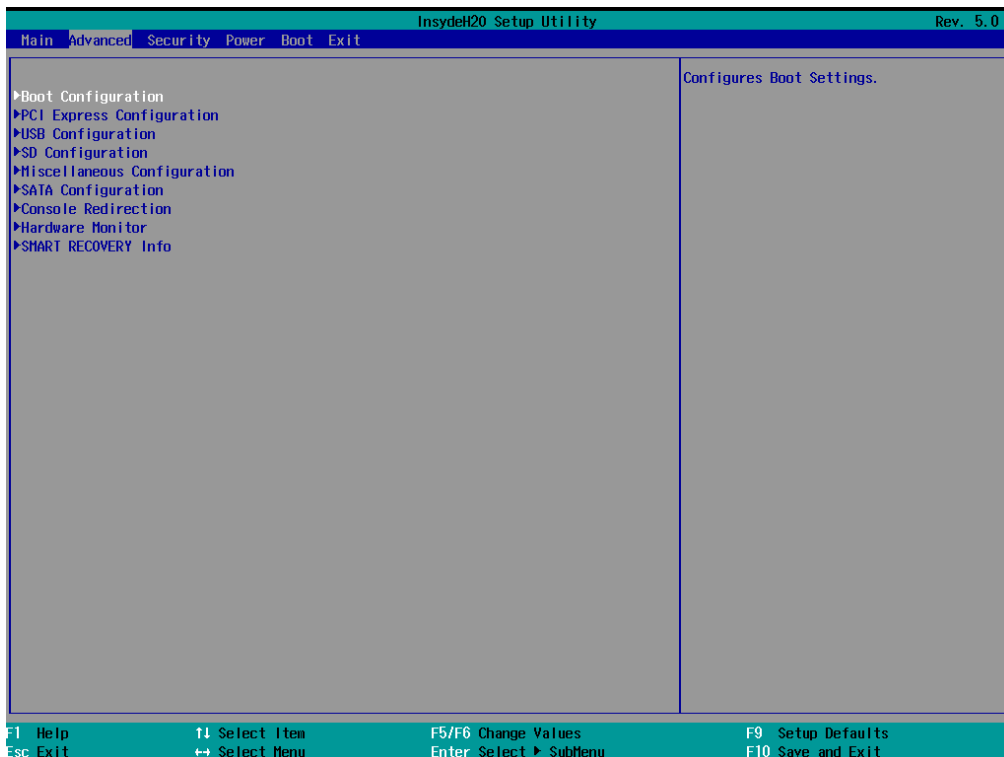

## Boot Configuration

This screen allows you to configure the initial status of the Numlock key when the computer boots up.

Options: On (default), Off

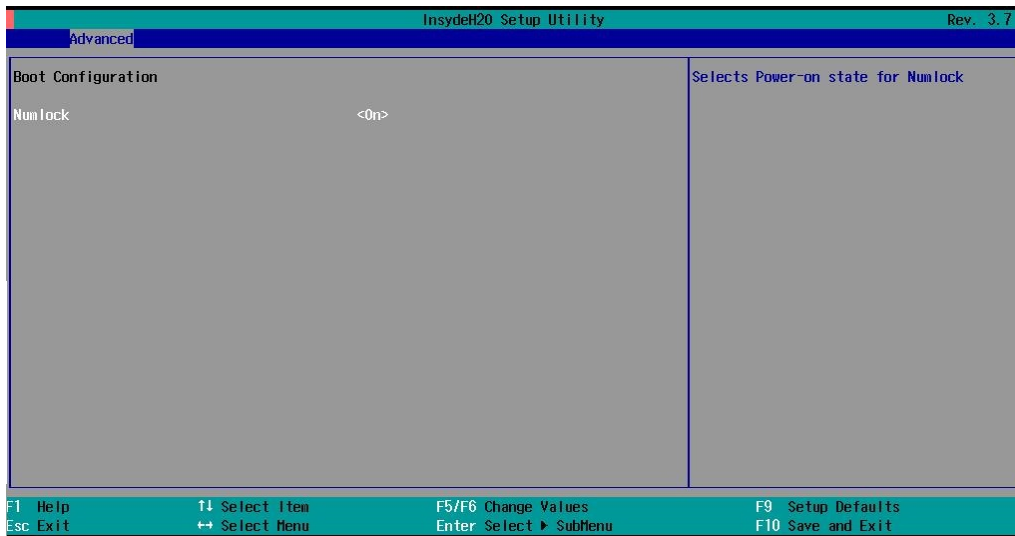

## PCI Express Configuration

### PCIE PORT 1 Speed

Configure PCIe Port1 Speed

Options: Auto, Gen1 and Gen2

### PCIE PORT 2 Speed

Configure PCIe Port2 Speed

Options: Auto, Gen1 and Gen2

### PCIE PORT 3 Speed

Configure PCIe Port3 Speed

Options: Auto, Gen1 and Gen2

### PCIE PORT 4Speed

Configure PCIe Port4 Speed

Options: Auto, Gen1 and Gen2

## USB Configuration

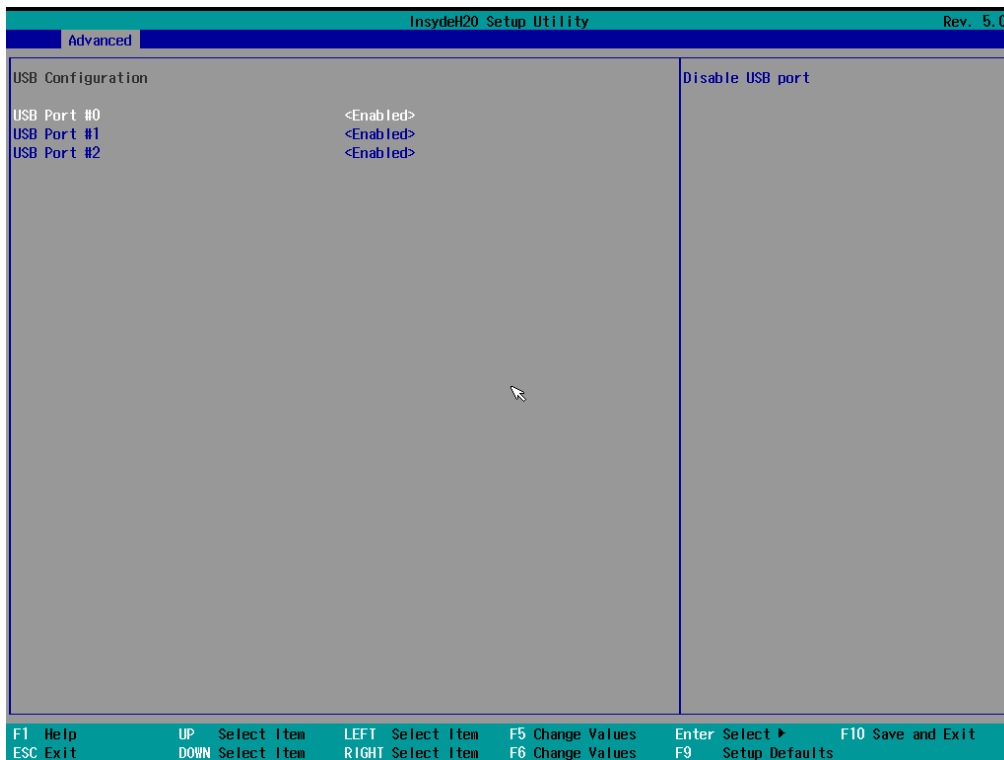

### USB Port #0

Enable or Disable USB port 0; if disabled, the system won't detect when a USB device is plugged in.

Option: Enabled (default), Disabled

### USB Port #1

Enable or Disable USB port 1; if disabled, the system won't detect when a USB device is plugged in.

Option: Enabled (default), Disabled

### USB Port #2

Enable or Disable USB port 2; if disabled, the system won't detect when a USB device is plugged in.

Option: Enabled (default), Disabled

### USB Port #3

Enable or Disable USB port 3; if disabled, the system won't detect when a USB device is plugged in.

Option: Enabled (default), Disabled

## SD Configuration (MC-1111 and MC-1121 Only)

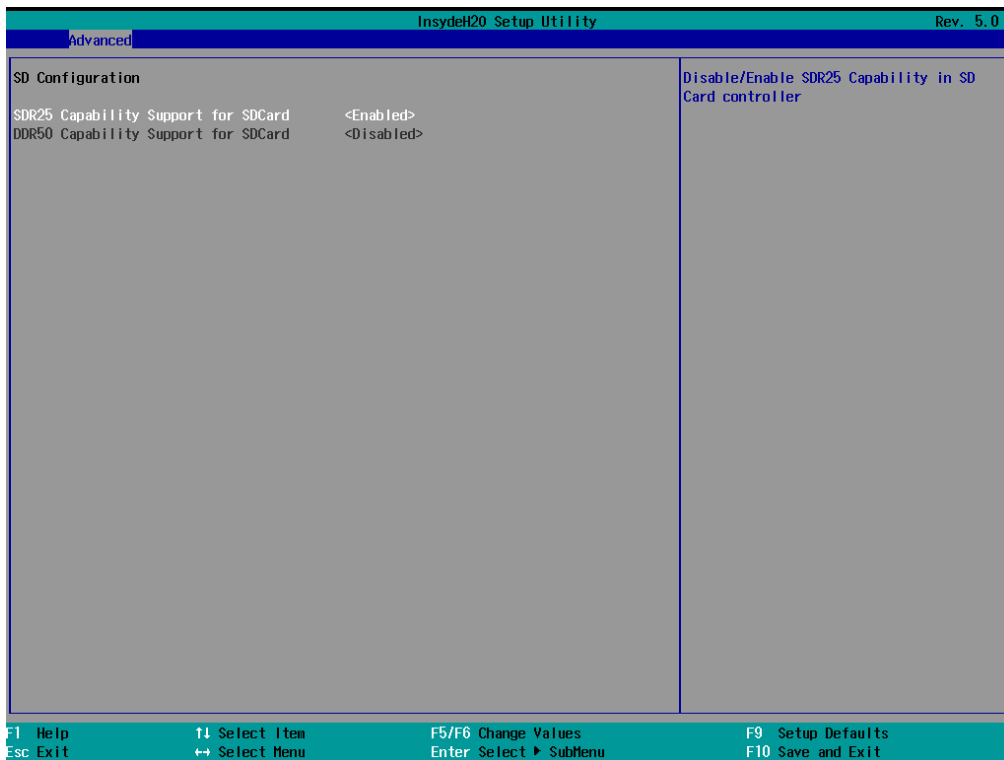

### SDR25 Capability Support for SD Card

Set Input/output timing for SDR25 mode.

Option: Enabled (default), Disabled

### DDR50 Capability Support for SD Card

Set Input/output timing for DDR50 mode.

Option: Enabled (default), Disabled

## Miscellaneous Configuration

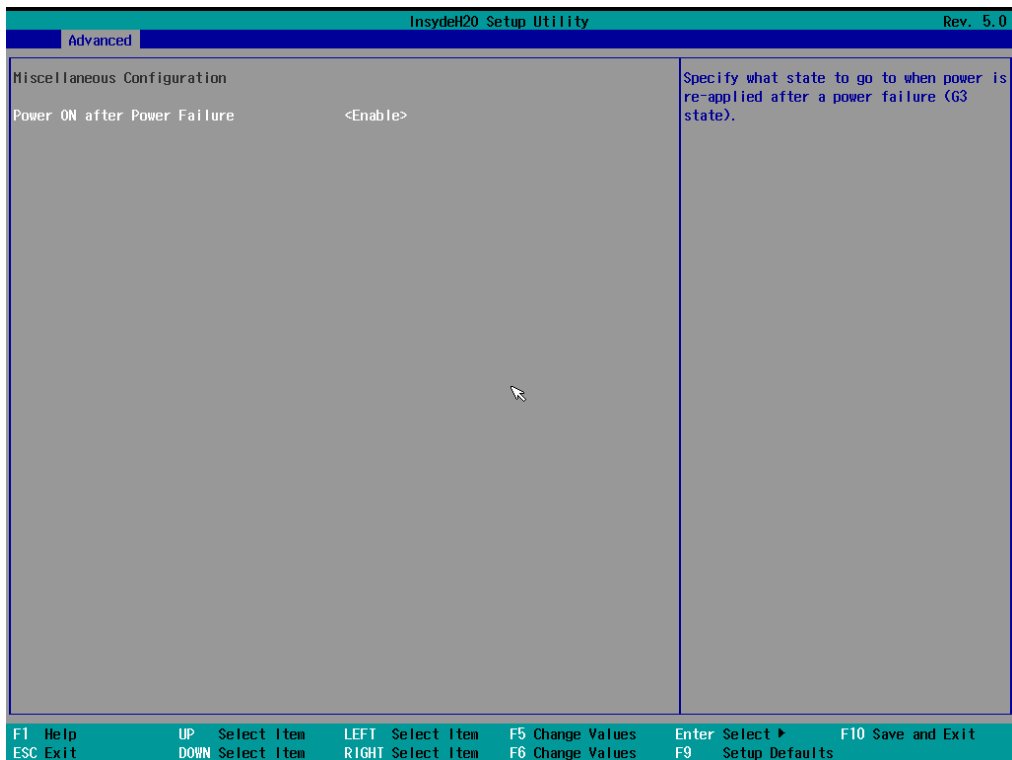

### Power ON after Power Failure

This setting allows you to configure whether or not the computer automatically reboot after a system crash. When set to ON, the computer will automatically reboot after a system crash; when set to OFF, it won't automatically reboot after a system crash. Options: ON (default), OFF, Last State.

**NOTE** This setting is only available in the MC-1121 and MC-1122 models.

### DO-0 Level

This item allows you set the DO 0 as high or low.

Options: High (default), Low

### DO-1 Level

This item allows you set the DO 1 as high or low.

Options: High (default), Low

### DO-2 Level

This item allows you set the DO 2 as high or low

Options: High (default), Low



## DO-3 Level

This item allows you set the DO 3 as high or low.

Options: High (default), Low

## SATA Configuration

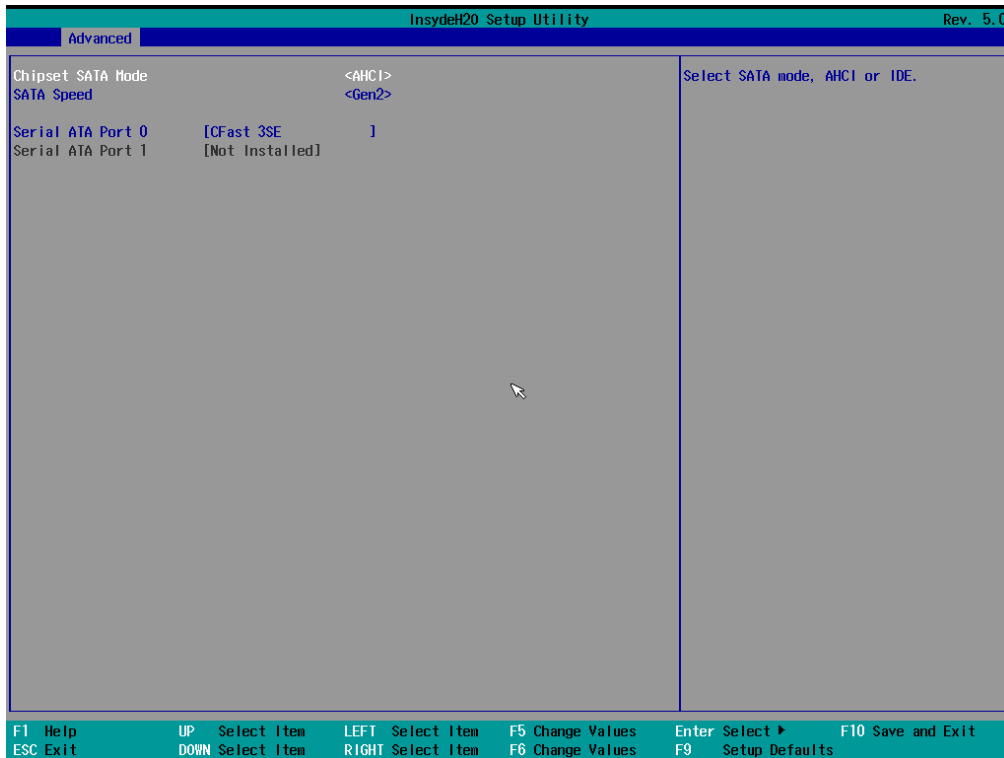

### Chipset SATA Mode

Select SATA mode

Options: AHCI (default), IDE

### SATA Speed

Select SATA Speed

Options: Gen1 (default), Gen2

## Console Redirection

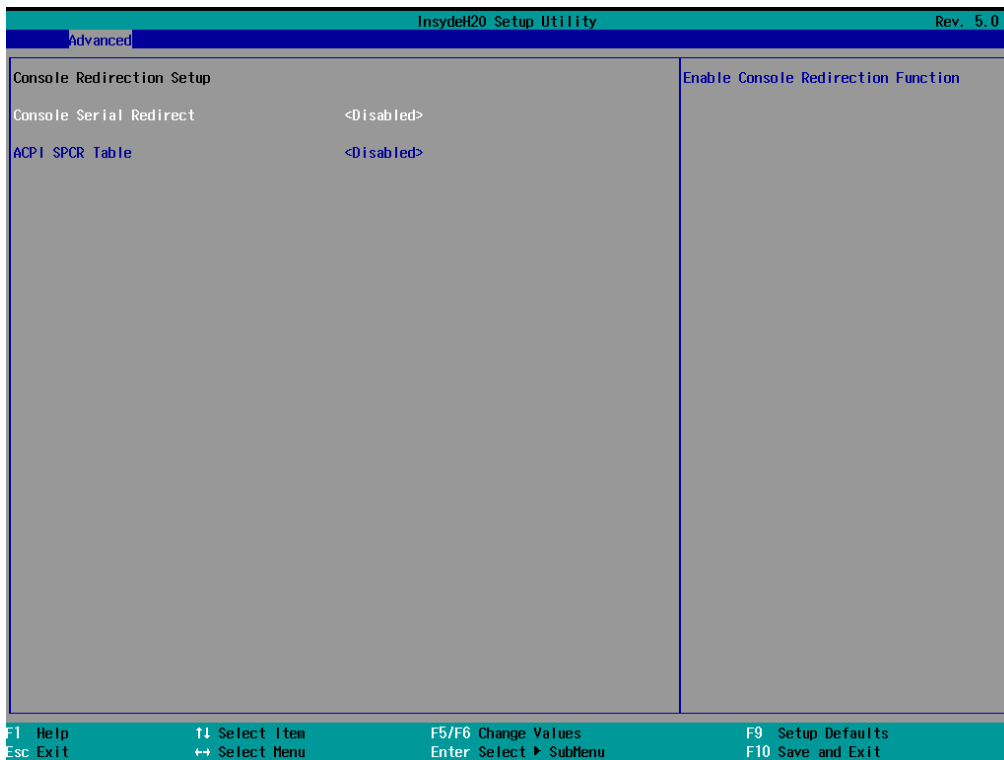

### Console Serial Redirect

When the Console Redirection Function is enabled, the console information will be output to both the HDMI monitor and through the serial port.

Options: Disabled (default), Enabled

### ACPI SPCR Table

This table is used to indicate whether a serial port or a non-legacy UART (Universal Asynchronous Receiver/Transmitter) interface is available for use with Microsoft Windows Emergency Management Services (EMS).

Options: Disabled (default), Enabled

## Hardware Monitor

This screen allows you to view voltage levels, system temperature, and CPU temperature.

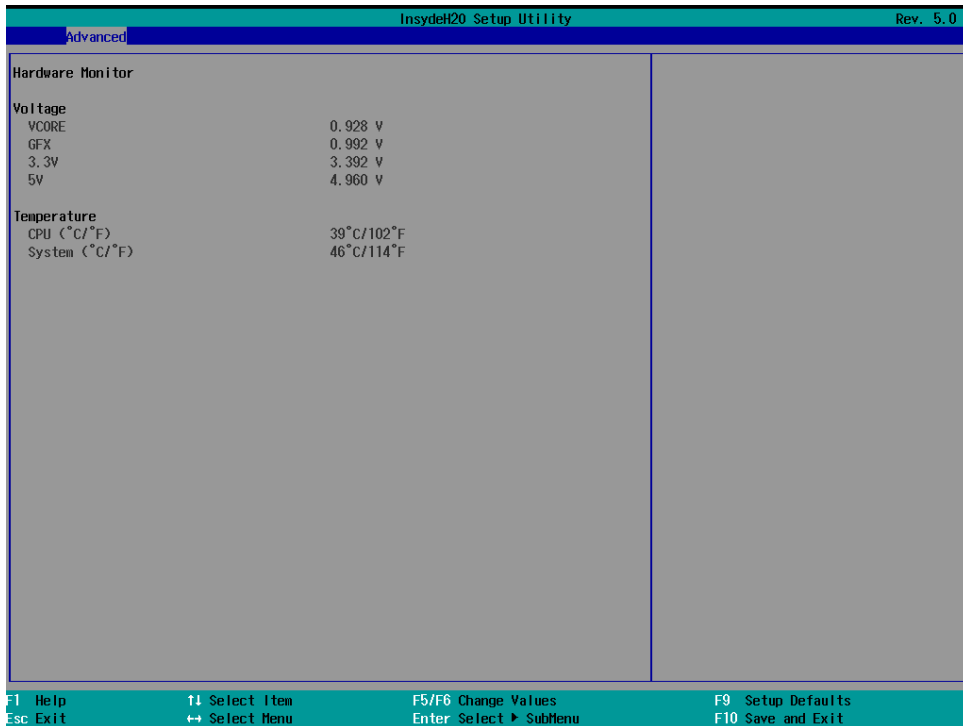

Note that the voltage values vary depending on the model. The temperature readings shown on the screen are within ±5% of the actual readings. However, the temperature readings are only valid when the ambient temperature is above 0°C.

## Smart Recovery Info

This screen allows you to view information on the Smart Recovery function.

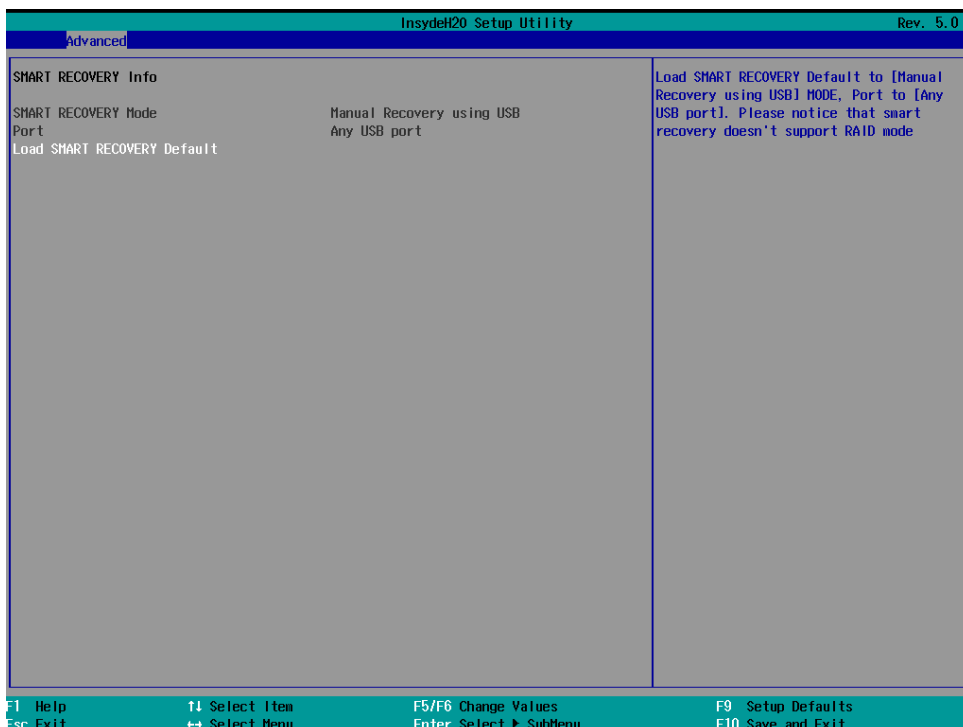

## Load Smart Recovery Default

This setting allows you to load the default values for the Smart Recovery function. Refer to the [Smart Recovery Website](#) for details.

Options: Yes (default), No

## Security Settings

This screen allows you to configure a supervisor password.

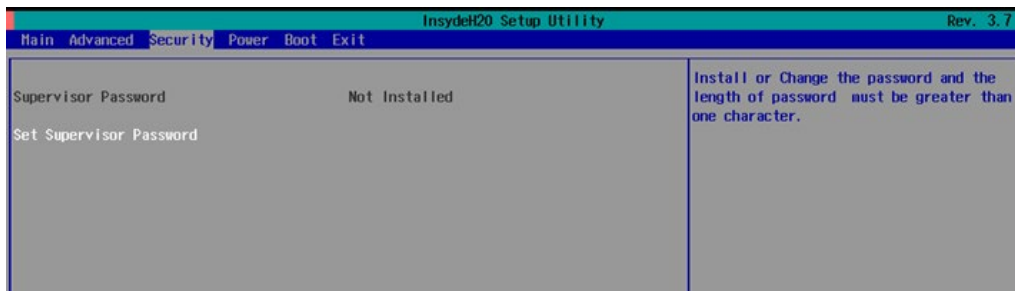

## Set Supervisor Password

This setting allows you set the supervisor password.

Type the new password, and then retype the password again to confirm.

To delete the password, enter the existing password in the **Set Supervisor Password** field and leave the two new password fields the follow blank; then, press [Enter].

Set Supervisor Password

Please type in your new password [  ]

Please confirm your new password [  ]

# Power Settings

The screen allows you to configure power settings.

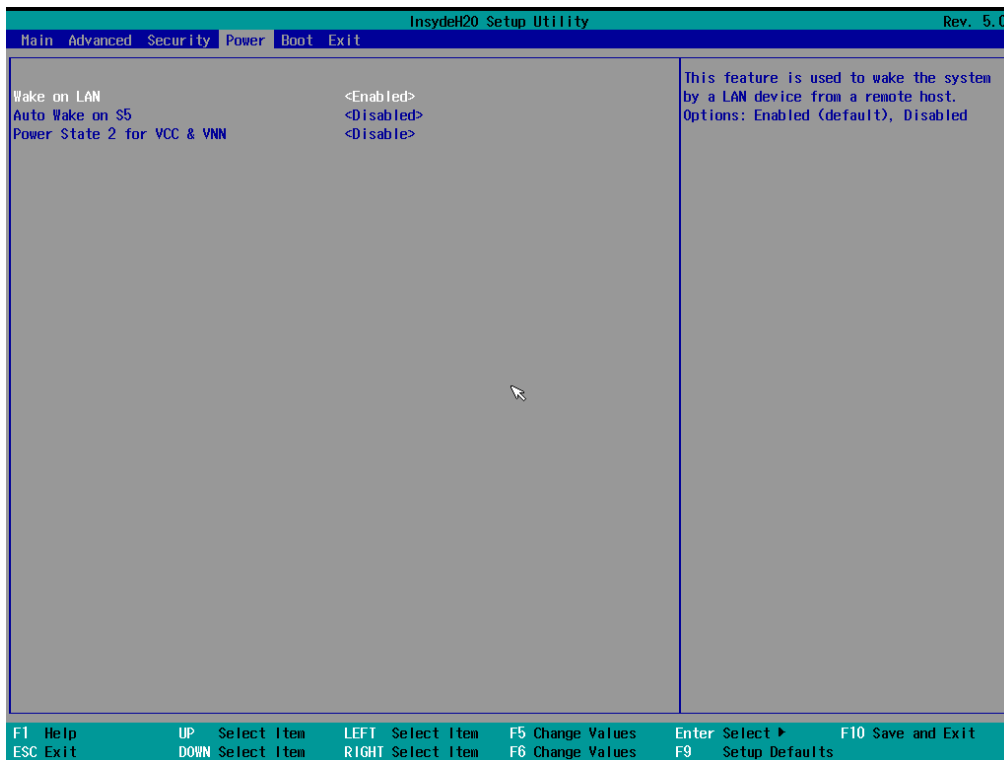

## Wake on LAN

This setting allows you to wake the system over the LAN from a remote host.

Options: Enabled (default), Disabled.

## Auto Wake on S5

This setting allows you to configure the computer to wake from the S5 (Soft Off) state where the power supply remains engaged but is not supplying power to all other parts of the system.

You can set the auto-wake on S5 schedules for the system to perform a soft-reboot at specific times.

Options: Disabled (default); By Every Day (user specifies at what time each day the computer will power up); By Day of Month (user specifies which day of each month the computer will power up)

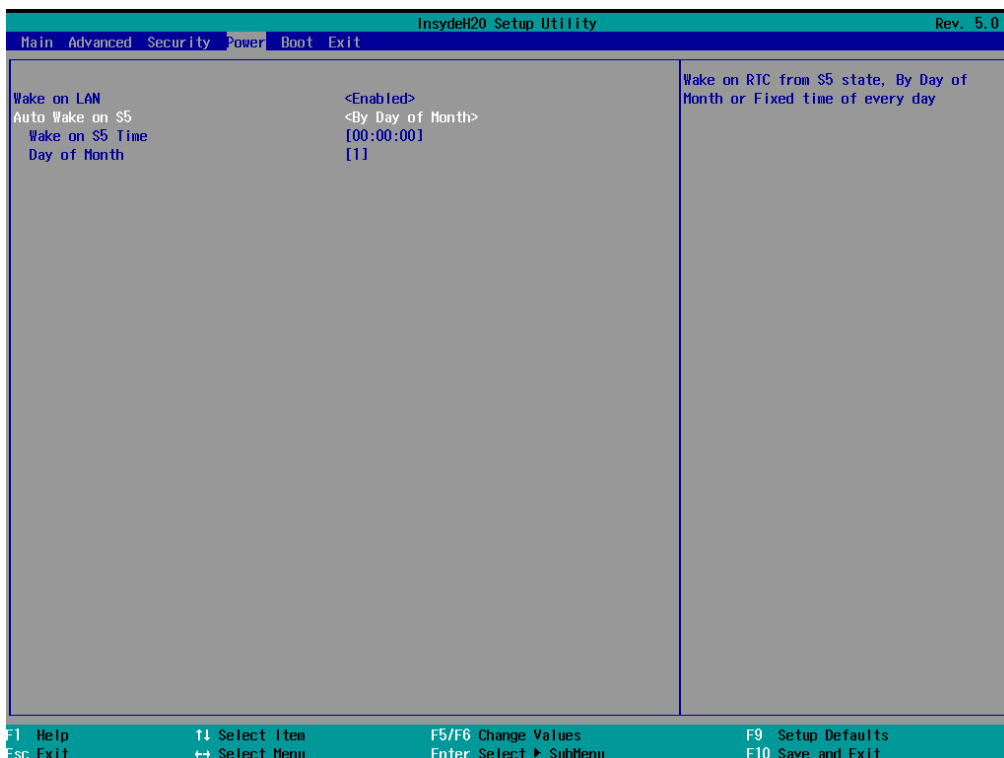
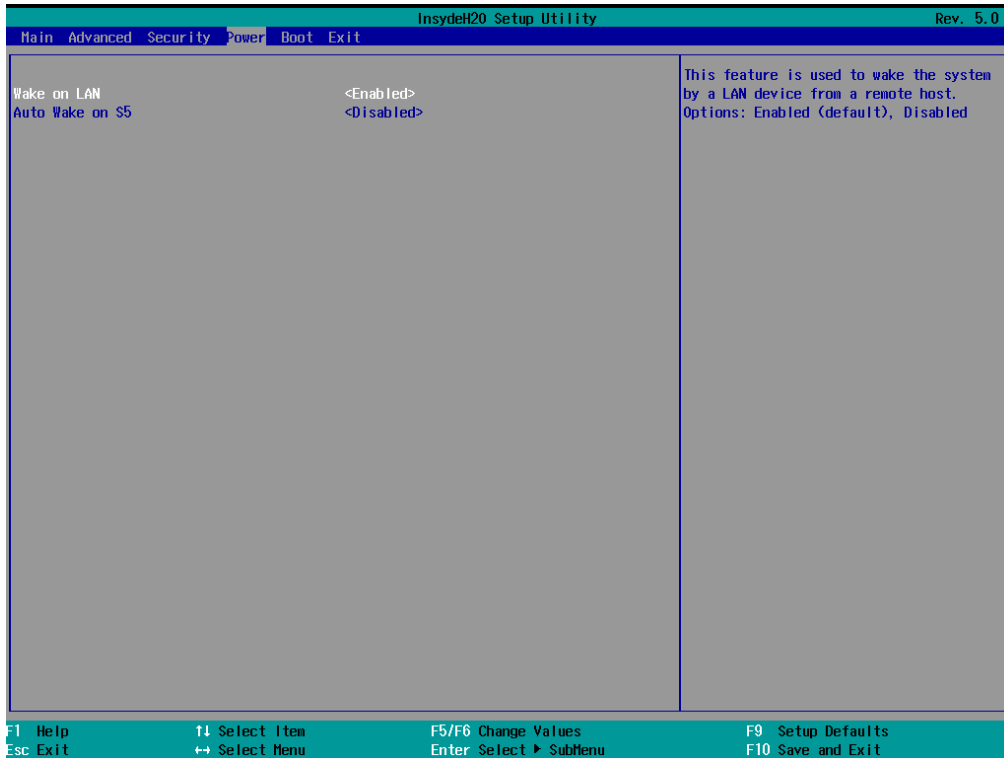

## Power State 2 for VCC & VNN

This setting allows you to enable/disable CPU core voltage (VCC) and graphics core voltage (VNN) rails for low-power scenarios in SOC S0 state.

Options: Enabled (default), Disabled.

## Boot Settings

The screen allows you to configure boot settings.



## Boot Type

The system will be based on the value used to build the boot environment for different types of operating systems.

Options: Dual Boot Type (default), Legacy Boot Type, UEFI Boot Type

## PXE Boot to LAN

This setting allows you to enable or disable the PXE boot to LAN function.

Options: Disabled (default), Enabled

## PXE Boot capability

This function is enabled while PXE Boot to LAN enabled.

Supports Network Stack UEFI PXE or Legacy.

Options: Disabled (default), UEFI: IPv4, Legacy

## Add Boot Options

This setting allows you to add boot order options for new boot devices and removable devices, such as a USB drive.

Options: Last (default), First, Auto

## USB Boot

This setting allows you to enable or disable the USB boot function.

Options: Enabled (default), Disabled

## Boot Delay Time

This setting allows you to configure the delay time to enter a hot key during POST.

Options: 0 Second (default), User define

## Automatic Failover

Options: Enabled (default), Disabled

Enable: If boot to default device fails, it will try to boot the next device.

Disable: If boot to default device fails, a warning message will pop up.

## Boot Order Priority

This setting allows you to determine the booting priority of the EFI device. If this setting is EFI first, the EFI device will boot first; if Legacy first, the legacy device will boot first.

Options: Legacy first (default), EFI first

## Legacy

### Normal Boot Menu

This setting allows you to configure the boot menu.

Options: Normal (default), Advance



## Boot Type Order

This setting allows you to configure the boot order. To change the boot order, press the "-" or "F5" key to an item move down the list, and the "+" or "F6" key to move up.

Options: Hard Disk Drive (default), CD/DVD-ROM Drive, USB, Others

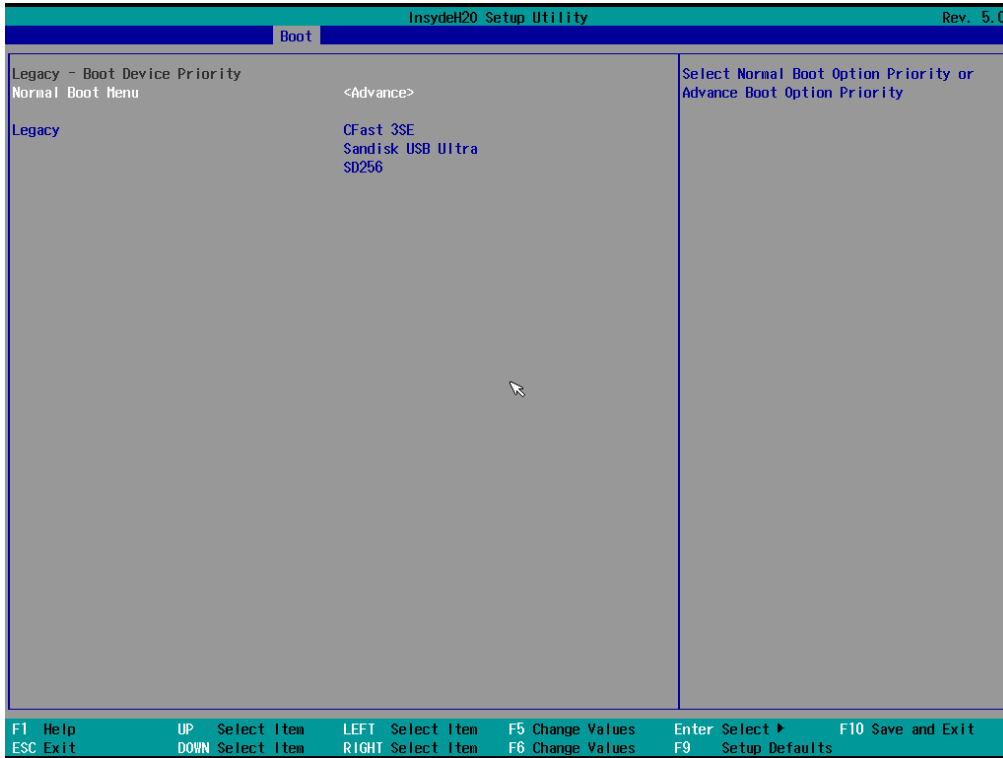

## EFI

Adjust boot order settings for an EFI device.

# Exit Settings

The screen shows the various options to exit from the BIOS setup utility.

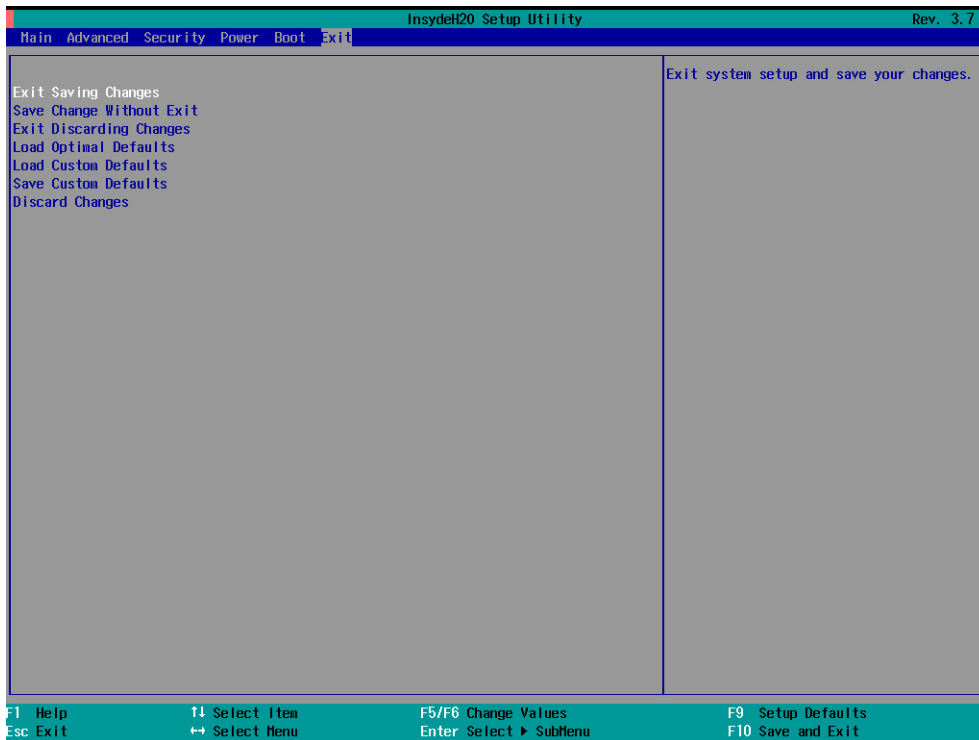

## Exit Saving Changes

This option allows you to exit the BIOS setup utility and save the values you have just configured.

Options: Yes (default), No

## Save Change Without Exiting

This option allows you to save changes without exiting the BIOS setup utility.

Options: Yes (default), No

## Exit Discarding Changes

This option allows you to exit without saving that changes that might have been made to the BIOS.

Options: Yes (default), No

## Load Optimal Defaults

This option allows you to revert to the factory default BIOS values.

Options: Yes (default), No

## Load Custom Defaults

This option allows you to load the custom default BIOS settings.

Options: Yes (default), No

## Save Custom Defaults

This option allows you to save the current BIOS settings as a “custom default” that you can load at any time using the “Load Custom Defaults” option.

Options: Yes (default), No

## Discard Changes

This option allows you to discard all settings you have just configured.

Options: Yes (default), No

## Upgrading the BIOS

This section describes how to upgrade the BIOS.



### WARNING

An improper BIOS upgrade process may permanently damage the computer. We strongly recommend that you contact Moxa technical support for assistance to obtain all the necessary tools and the most up-to-date advice before attempting to upgrade the BIOS on any Moxa device.

### Step 1: Create a Bootable USB Disk

Before upgrading the BIOS, every user should first create a bootable USB drive as a system rescue device.

A useful software suite for creating USB RAM drives can be found by searching for Rufus, which can then be downloaded and used to create a bootable RAM drive.

Complete the following steps to create a bootable USB disk using Rufus:

1. Start Rufus\* and then in the “Device” drop-down list select the USB device that you want to use as a bootable disk.  
\*Rufus official website:  
[https://rufus.akeo.ie/?locale=en\\_US](https://rufus.akeo.ie/?locale=en_US)
2. Select **MBR partition scheme for BIOS or UEFI computers** from the “Partition scheme and target system type” drop-down list so it can boot from a legacy BIOS or UEFI.
3. Select **FAT32 (Default)** from the “File system” drop-down list.
4. Select **4096 bytes (Default)** from the “Cluster size” drop-down list.
5. Enter a drive name in the “New volume label” input box.
6. Check the **Quick format**, **Create a bootable disk using FreeDOS**, and **Create extended label and icon files** options.
7. Click **Start** to format and create the bootable USB drive.

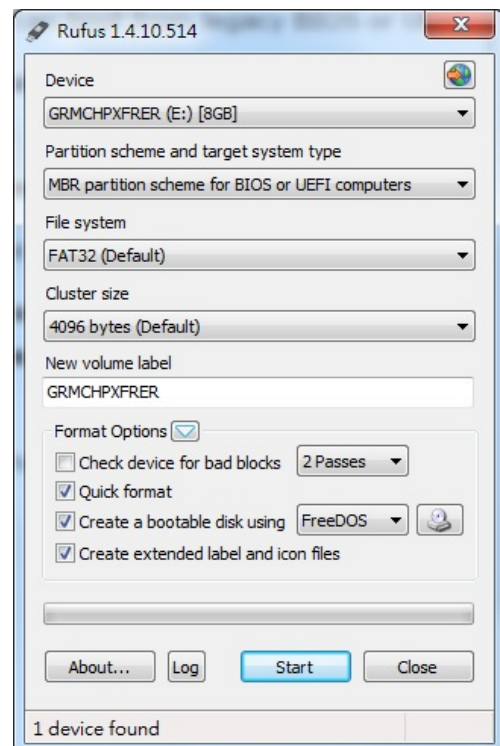

**ATTENTION**

When you use a USB drive larger than 4 GB, you will need to convert the file system type to FAT32.

**Step 2: Prepare the Upgrade File**

You must use the BIOS upgrade installation file to upgrade the BIOS. Contact Moxa technical support for assistance.

1. Get the BIOS upgrade installation file.  
The file name should be in the format: **MC-1100\_VxxxSxx.exe** (where "xx" refers to the version numbers).
2. Copy the file to the bootable USB drive.

**Step 3: Run the Upgrade Program on the MC-1100 Computer**

1. Reboot the computer, and press F2 during the booting process to display the Boot Manager.

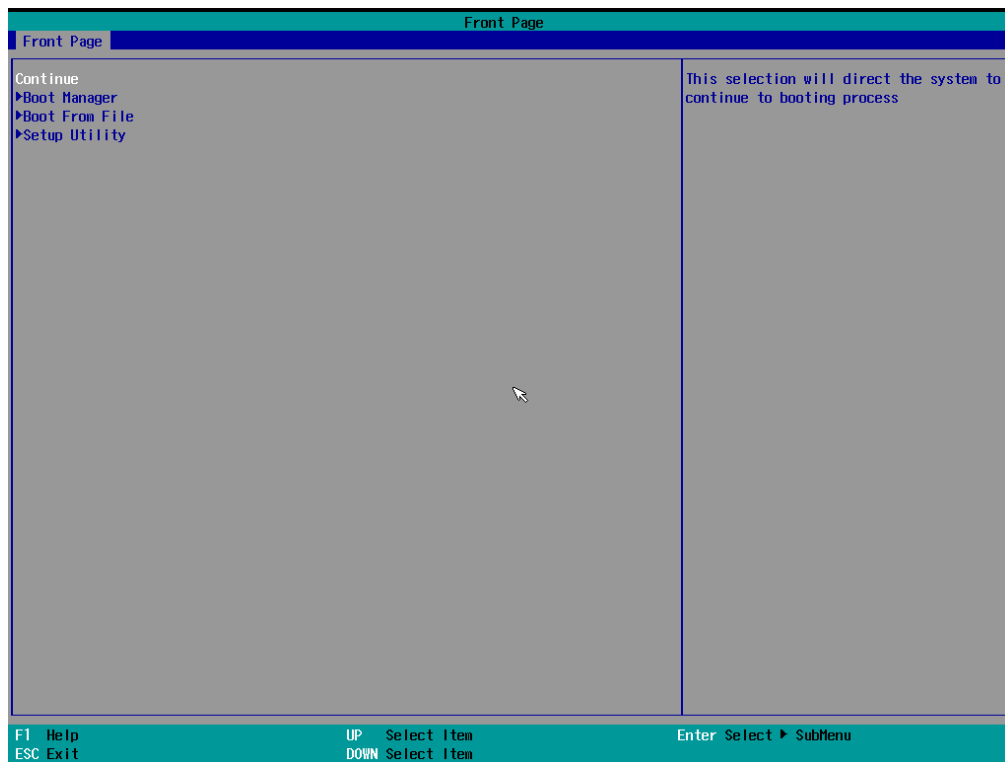

2. Select USB Disk as the first boot source and press [Enter] to continue.



3. When the computer finishes booting up, a command window appears. Go to the directory where the upgrade file is located. For example, if the upgrade file is stored in the MC-1100 folder, type `cd MC-1100`.

```
C:\>cd MC-1100
```

4. Run the upgrade program by typing `MC-1100S10.exe`.  
Note that the filename for the upgrade program may vary depending on the version.

```
C:\MC-1100>MC-1100S10.exe
```

5. The upgrade program will run automatically. Wait until the procedure is complete.



#### ATTENTION

Do NOT remove the power supply during a BIOS upgrade.

```
C:\>MC-1100>MC-1100S10.exe
Option: -bios -all -nv
```

**Please do not remove the AC power!**

```
Insyde H20FFT (Flash Firmware Tool) Version (SEG) 100.00.07.20
Copyright(c) 2012 - 2014, Insyde Software Corp. All Rights
Reserved.

Initializing

Current BIOS Model name: MC-1100
New BIOS Model name: MC-1100

Current BIOS version: V1.00S10
New BIOS version: V1.00S10

Updating Block at FFFFF000
```

0%            25%            50%            75%            100%



100%

- When the upgrade is finished, the computer automatically reboots. You may check the BIOS version on the Main page of the BIOS setup utility.

BIOS Version	V1.00S10
Project Name	MC-1100

# A

## Regulatory Approval Statement

---



This device complies with part 15 of the FCC Rules. Operation is subject to the following two conditions: (1) This device may not cause harmful interference, and (2) this device must accept any interference received, including interference that may cause undesired operation.

**Class A :** FCC Warning! This equipment has been tested and found to comply with the limits for a Class A digital device, pursuant to part 15 of the FCC Rules. These limits are designed to provide reasonable protection against harmful interference when the equipment is operated in a commercial environment. This equipment generates, uses, and can radiate radio frequency energy and, if not installed and used in accordance with the instruction manual, may cause harmful interference to radio communications. Operation of this equipment in a residential area is likely to cause harmful interference in which case the users will be required to correct the interference at their own expense.



**European Community**

**Warning:**

This is a class A product. If used in a domestic environment, this product may cause undesirable radio interference, in which case the user may be required to take adequate measures to prevent the interference from affecting nearby devices.

# B

## Configuring the Serial Interface

---

In this chapter, we describe how to configure the MC-1100 embedded computer's serial interface.

The following topics are covered in this appendix:

- **Overview**
- **Configuring the Serial Interface Mode**



## Overview

The MC-1100's COM1 and COM2 serial ports support the following serial modes: **RS-232**, **2-wire RS-485**, and **4-wire RS-422/485**.

## Configuring the Serial Interface Mode

Complete the following steps to configure the serial interface mode:

1. From the Start menu, Click **All Programs** → **Moxa** → **mxSetSerialInterface**.

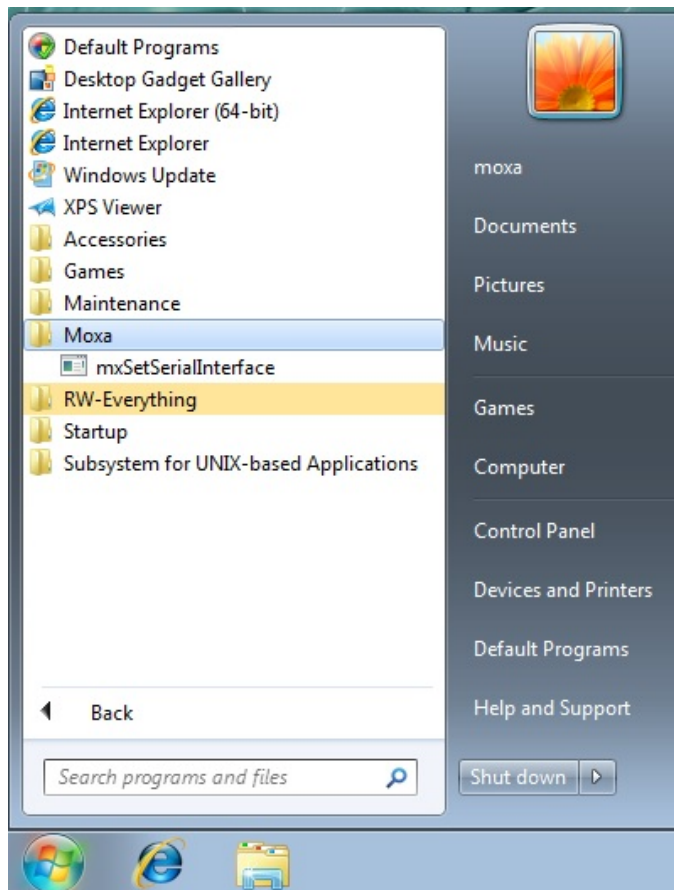

2. Select the port you would like to configure from the **Port** dropdown box.

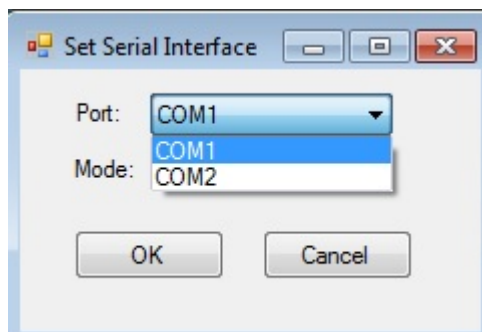

3. Select the serial interface mode for the port from the **Mode** dropdown box.

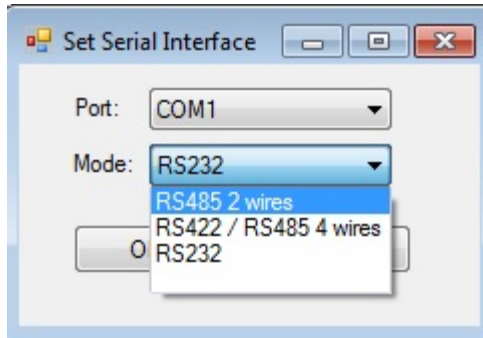

4. Click **OK**.

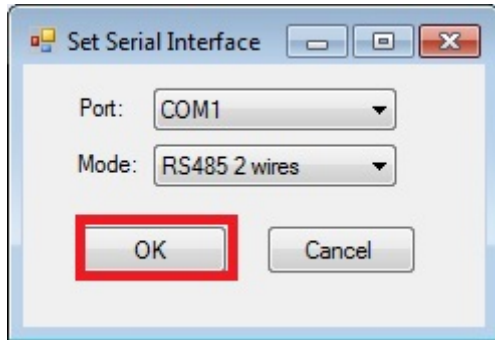

# C

## Examples

---

In this chapter, we provide examples to illustrate how to use the MC-1100 computer for a variety of applications.

The following topics are covered in this appendix:

- ❑ **Serial Interface**
- ❑ **Digital Input/Output**
- ❑ **Watchdog**
- ❑ **Power Control**



5. Type **1** to display the current serial interface settings.

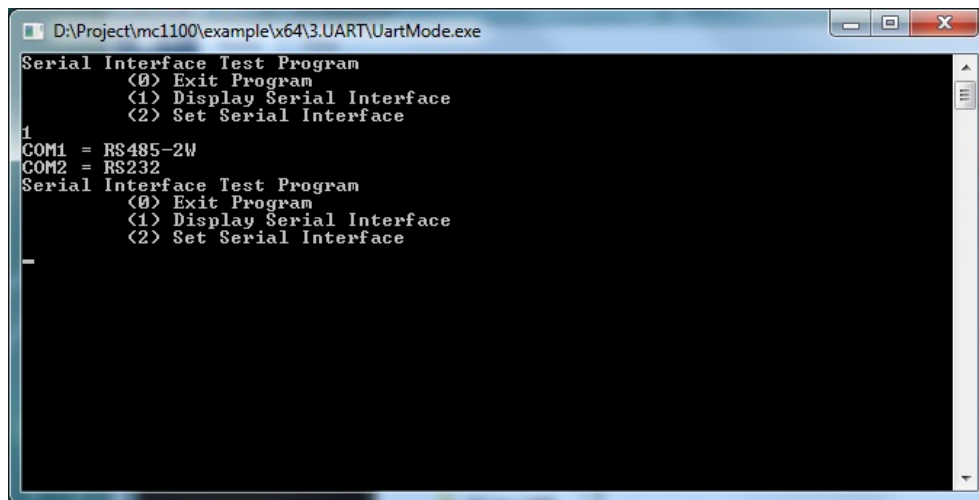

```
D:\Project\mc1100\example\x64\3.UART\UartMode.exe
Serial Interface Test Program
  <0> Exit Program
  <1> Display Serial Interface
  <2> Set Serial Interface
1
COM1 = RS485-2W
COM2 = RS232
Serial Interface Test Program
  <0> Exit Program
  <1> Display Serial Interface
  <2> Set Serial Interface
```

## Digital Input/Output

1. Download the MC-1100 Utility Package from: [https://www.moxa.com/product/MC-1100\\_Series.htm](https://www.moxa.com/product/MC-1100_Series.htm)
2. Copy the following files from the MC-1100 Utility Package to a folder on your MC-1100.  
**mxdgio.dll:** \examples\MC-1100-W7E-example\3.lib\mxdgio\x64\  
**mxGeneralIo.dll:** \examples\MC-1100-W7E-example\3.lib\MxGeneralIo\x64\  
**DIO.exe:** \examples\MC-1100-W7E-example\x64\Release\  
3. Execute **DIO.exe**.

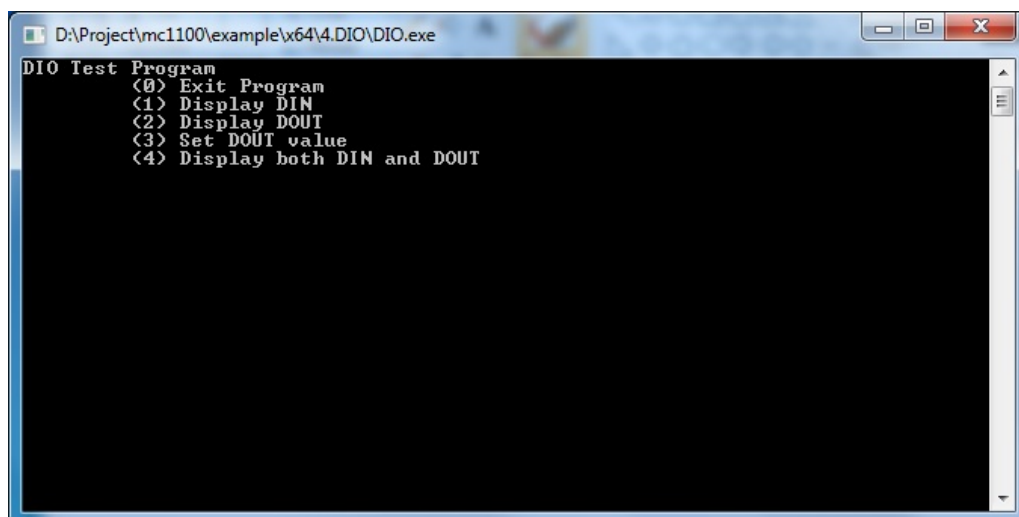

```
D:\Project\mc1100\example\x64\4.DIO\DIO.exe
DIO Test Program
  <0> Exit Program
  <1> Display DIN
  <2> Display DOUT
  <3> Set DOUT value
  <4> Display both DIN and DOUT
```

4. Type **4** to display the current DI and DO values.

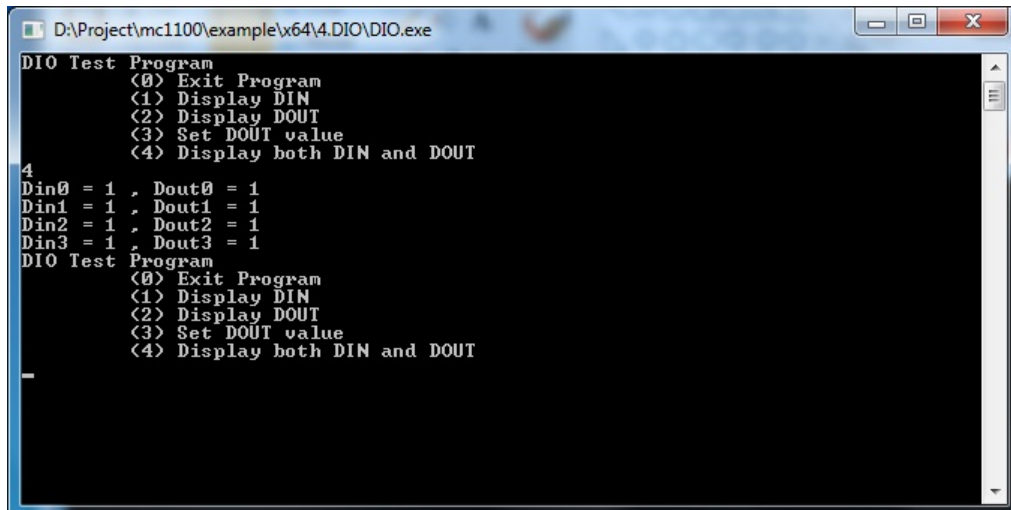

```

D:\Project\mc1100\example\x64\4.DIO\DIO.exe
DIO Test Program
  (0) Exit Program
  (1) Display DIN
  (2) Display DOUT
  (3) Set DOUT value
  (4) Display both DIN and DOUT
4
Din0 = 1 , Dout0 = 1
Din1 = 1 , Dout1 = 1
Din2 = 1 , Dout2 = 1
Din3 = 1 , Dout3 = 1
DIO Test Program
  (0) Exit Program
  (1) Display DIN
  (2) Display DOUT
  (3) Set DOUT value
  (4) Display both DIN and DOUT

```

5. Type **3** to set the DOUT port number, and then follow the onscreen instructions.

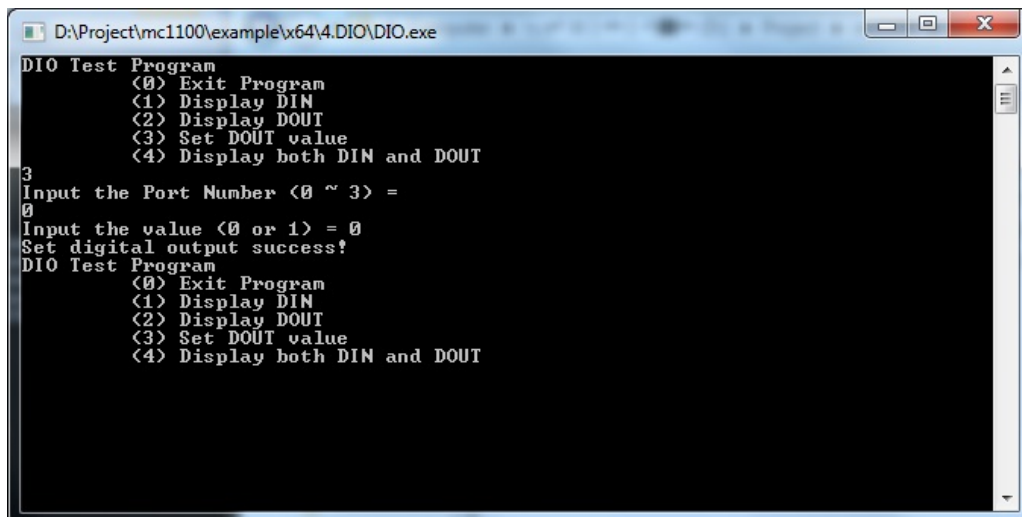

```

D:\Project\mc1100\example\x64\4.DIO\DIO.exe
DIO Test Program
  (0) Exit Program
  (1) Display DIN
  (2) Display DOUT
  (3) Set DOUT value
  (4) Display both DIN and DOUT
3
Input the Port Number (0 ~ 3) =
0
Input the value (0 or 1) = 0
Set digital output success!
DIO Test Program
  (0) Exit Program
  (1) Display DIN
  (2) Display DOUT
  (3) Set DOUT value
  (4) Display both DIN and DOUT

```

6. Type **4** to check if the port value was set correctly.

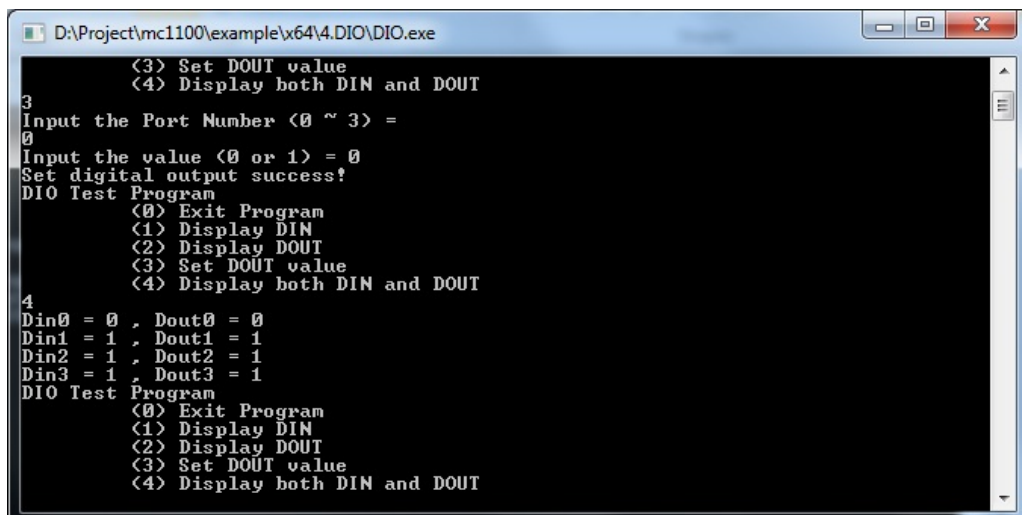

```

D:\Project\mc1100\example\x64\4.DIO\DIO.exe
  (3) Set DOUT value
  (4) Display both DIN and DOUT
3
Input the Port Number (0 ~ 3) =
0
Input the value (0 or 1) = 0
Set digital output success!
DIO Test Program
  (0) Exit Program
  (1) Display DIN
  (2) Display DOUT
  (3) Set DOUT value
  (4) Display both DIN and DOUT
4
Din0 = 0 , Dout0 = 0
Din1 = 1 , Dout1 = 1
Din2 = 1 , Dout2 = 1
Din3 = 1 , Dout3 = 1
DIO Test Program
  (0) Exit Program
  (1) Display DIN
  (2) Display DOUT
  (3) Set DOUT value
  (4) Display both DIN and DOUT

```

# Watchdog

1. Download the MC-1100 Utility Package from: [https://www.moxa.com/product/MC-1100\\_Series.htm](https://www.moxa.com/product/MC-1100_Series.htm)
2. Copy the following files from the MC-1100 Utility Package to a folder on your MC-1100.  
**mxdwg.dll:** \examples\MC-1100-W7E-example\3.lib\mxdwg\x64\  
**mxGeneralIo.dll:** \examples\MC-1100-W7E-example\3.lib\MxGeneralIo\x64\  
**Watchdog.exe:** \examples\MC-1100-W7E-example\x64\Release\
3. To prevent the system from rebooting, press [Enter] at least once every 10 seconds; otherwise, the system will reboot automatically.

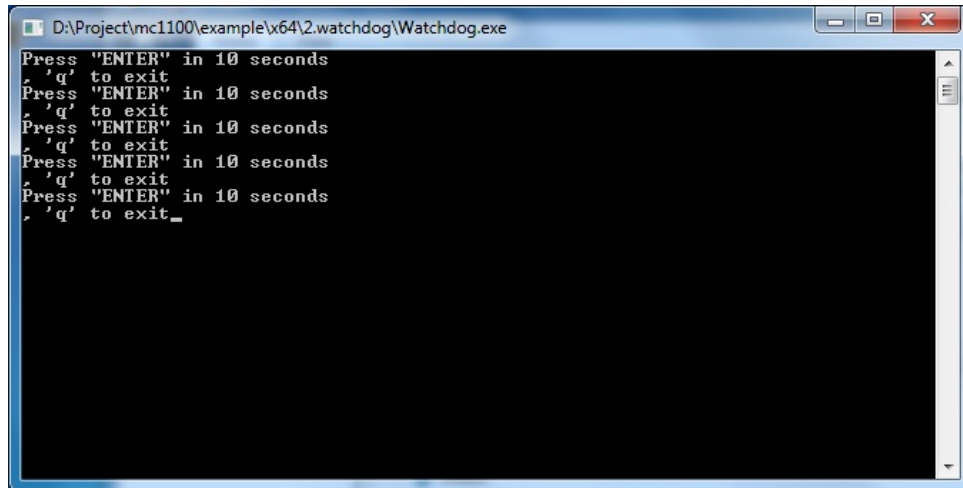

```
D:\Project\mc1100\example\x64\2.watchdog\Watchdog.exe
Press "ENTER" in 10 seconds
'q' to exit
Press "ENTER" in 10 seconds
'q' to exit
Press "ENTER" in 10 seconds
'q' to exit
Press "ENTER" in 10 seconds
'q' to exit
Press "ENTER" in 10 seconds
'q' to exit
Press "ENTER" in 10 seconds
'q' to exit_
```

Press **q** and **ENTER** to exit the program.

# Power Control

In this section, we illustrate how to use the test utility to control power through the mini-PCIE interface.

1. Download the MC-1100 Utility Package from: [https://www.moxa.com/product/MC-1100\\_Series.htm](https://www.moxa.com/product/MC-1100_Series.htm)
2. Copy the following files from the MC-1100 Utility Package to a folder on your MC-1100.  
**mxgpio.dll:** \examples\MC-1100-W7E-example\3.lib\mxgpio\x64\  
**mxGeneralIo.dll:** \examples\MC-1100-W7E-example\3.lib\MxGeneralIo\x64\  
**PwrExample.exe:** \examples\MC-1100-W7E-example\x64\Release\
3. Execute **PwrExample.exe**.

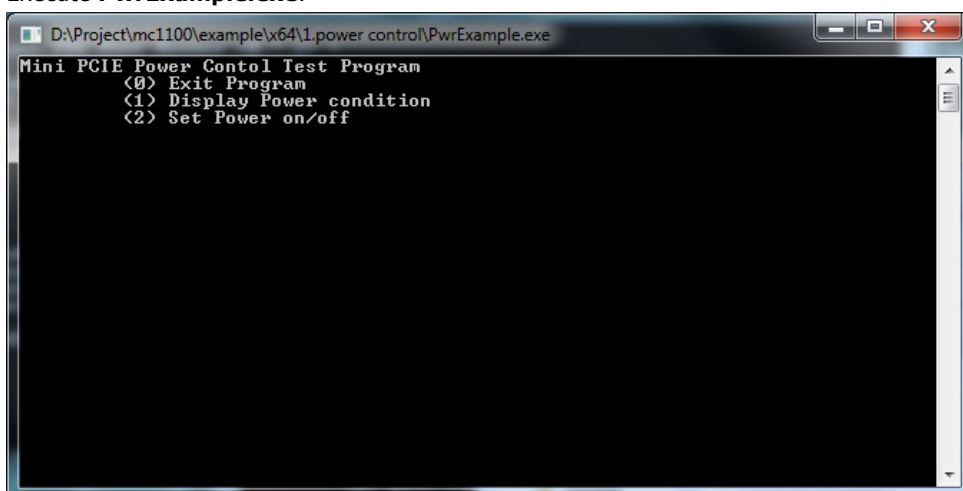

```
D:\Project\mc1100\example\x64\1.power control\PwrExample.exe
Mini PCIE Power Control Test Program
<u>0</u> Exit Program
<u>1</u> Display Power condition
<u>2</u> Set Power on/off

```

4. Type **1** to display the current power status.

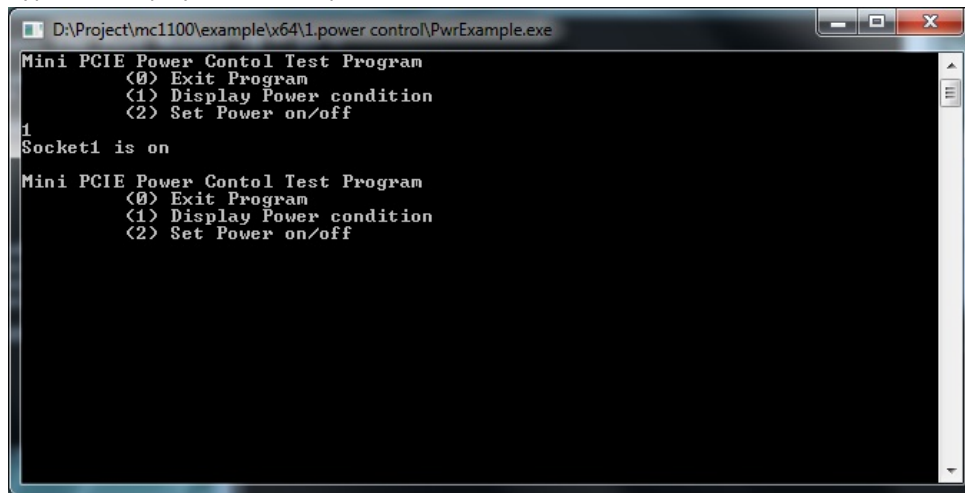

```
D:\Project\mc1100\example\x64\1.power control\PwrExample.exe
Mini PCIe Power Control Test Program
<0> Exit Program
<1> Display Power condition
<2> Set Power on/off
1
Socket1 is on
Mini PCIe Power Control Test Program
<0> Exit Program
<1> Display Power condition
<2> Set Power on/off
```

5. Type **2** and follow the onscreen instructions to set the power value.  
When you set the power value to 0, the power turns off.  
When you set the power value to 1, the power turns on.

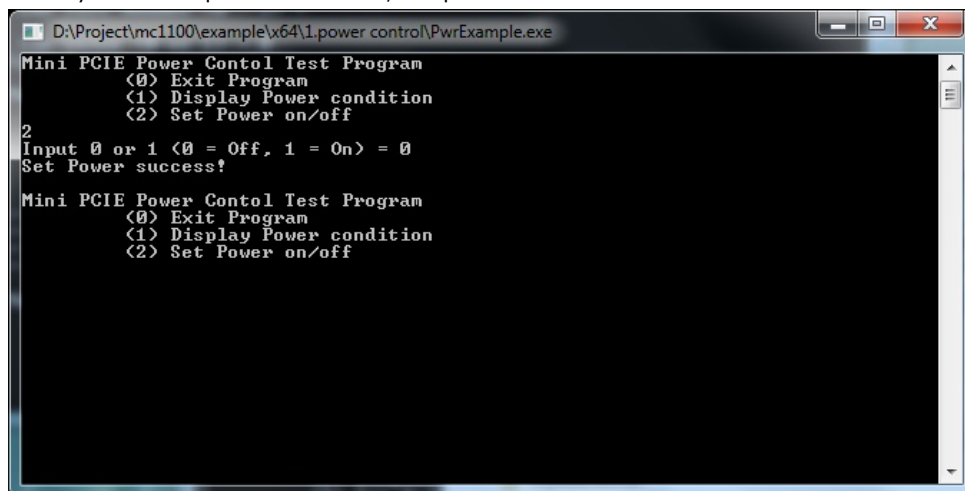

```
D:\Project\mc1100\example\x64\1.power control\PwrExample.exe
Mini PCIe Power Control Test Program
<0> Exit Program
<1> Display Power condition
<2> Set Power on/off
2
Input 0 or 1 <0 = Off, 1 = On> = 0
Set Power success!
Mini PCIe Power Control Test Program
<0> Exit Program
<1> Display Power condition
<2> Set Power on/off
```



## **Telit LE910 Module for the SMS Function**

---

In this chapter, we set up a test environment to send an SMS from the Telit LE910 module on the MC-1100 to a cell phone and verify that the message is delivered properly.

The following topics are covered in this appendix:

- **Setting Up the Test Environment**
  - Prerequisites
  - Setting Up the Test System
- **Using MxTerm to Test the SMS Function**
- **Using a Sample Program to Test the SMS Function**

# Setting Up the Test Environment

## Prerequisites

You will need the following to set up the test environment.

Type	Description
OS	Windows 10 IoT 2016
Software	<ul style="list-style-type: none"> <li>Moxa's PComm Lite utility (Mxterm.exe)</li> <li>Sample code*</li> </ul>
Hardware	<ul style="list-style-type: none"> <li>MC-1121 / MC-1122</li> <li>Telit LE910 module</li> </ul>

\*The sample code can be downloaded from MC-1100's product page.

## Setting Up the Test System

Once you have set up the hardware, use the following steps to set up the test environment.

1. Check the properties of the Telit Module.
  - a. Open the Device Manager: **Start-> Controls -> Device Manager**
  - b. Double-click on **Telit LE Family USB Modem device** item under **Modems -> Telit LE Family USB Modem**.

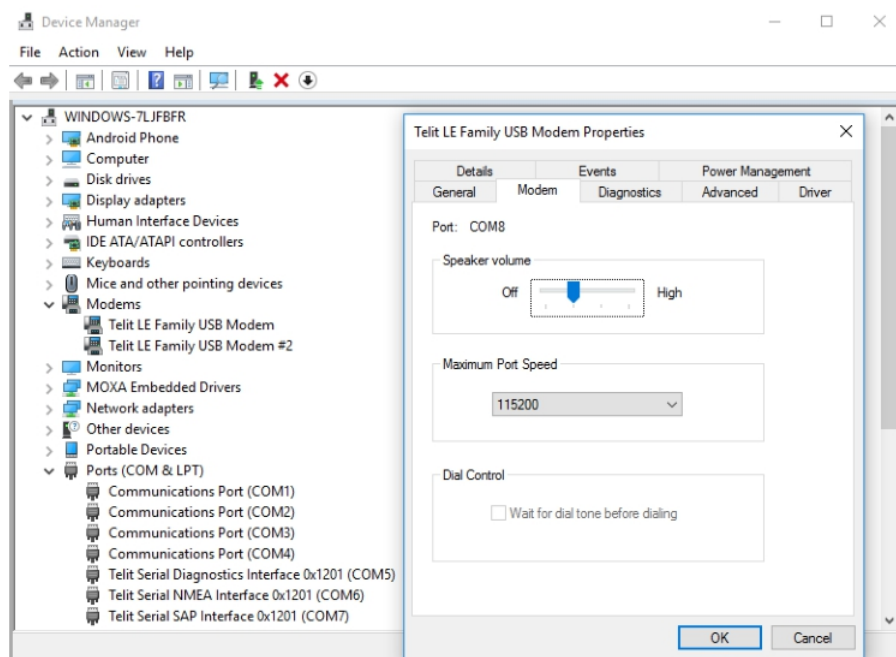

2. Download and install Moxa's PComm Lite utility from: [https://www.moxa.com/product/download\\_pcomm-lite\\_info.htm](https://www.moxa.com/product/download_pcomm-lite_info.htm)
3. Open the PComm Terminal Emulator and setup the COM port parameters (E.g.: COM8, Speed: 115200)
4. Unlock the SIM card and check the SIM card status.

Action	Command and Result
Check PIN status	<b>AT+CPIN?</b>  <b>+CPIN: READY</b> - ME is not awaiting any password <b>+CPIN: SIM PIN</b> - ME is awaiting the SIM PIN
Enter PIN code	<b>AT+CPIN=&lt;pin&gt;</b>  For example, enter the default pin code, AT+CPIN=0000

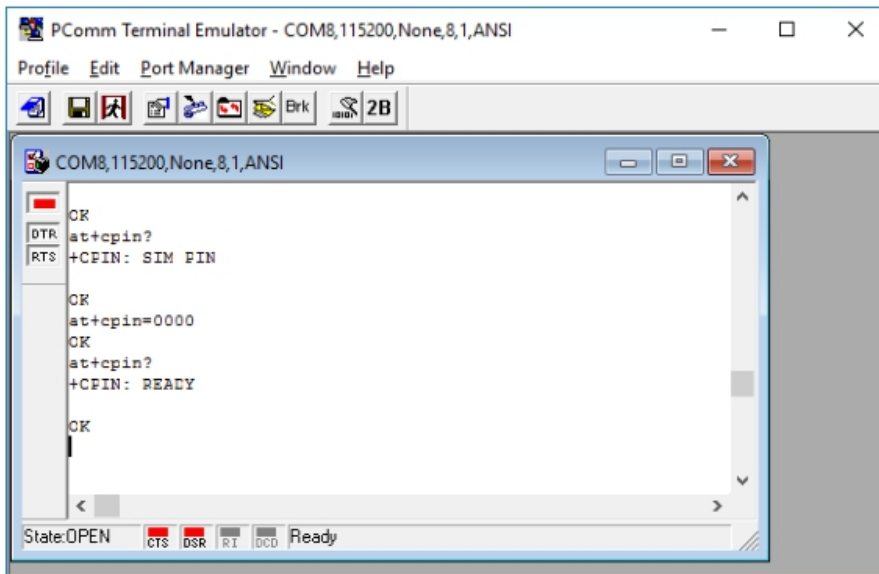

After you see the result **+CPIN: Ready**, go to next step.

5. Check the network registration status.

Action	Command and Result
Check network registration	<p><b>AT+CREG=[ &lt;mode&gt; ]</b></p> <p><i>&lt;mode&gt;</i>:</p> <ul style="list-style-type: none"> <li>• 0—disable network registration unsolicited result code (factory default)</li> <li>• 1—enable network registration unsolicited result code</li> <li>• 2—enable network registration unsolicited result code with network Cell identification data</li> </ul>

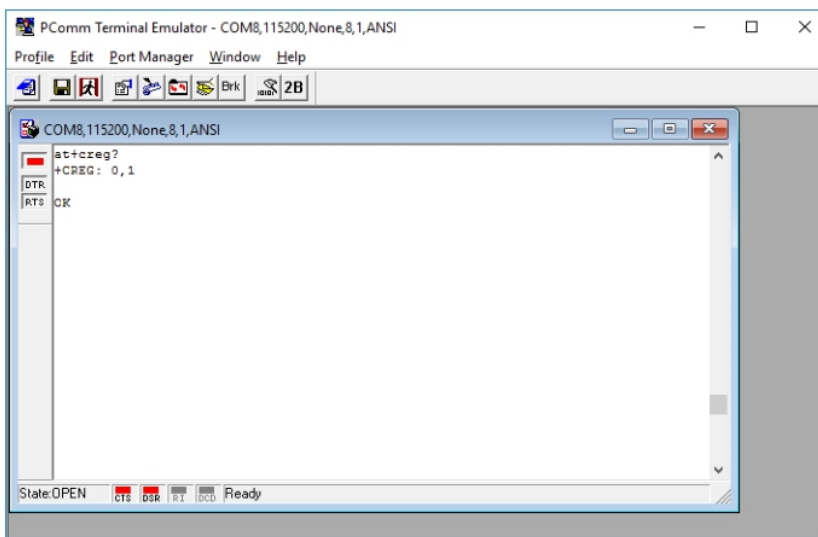

6. Set the Message Format to Text mode.

Action	Command and Result
Change Message Format	<p><b>AT+CMGF=[ &lt;mode&gt; ]</b></p> <p><i>&lt;mode&gt;</i></p> <ul style="list-style-type: none"> <li>• 0—PDU mode, as defined in GSM 3.40 and GSM 3.41 (factory default)</li> <li>• 1—Text mode</li> </ul>

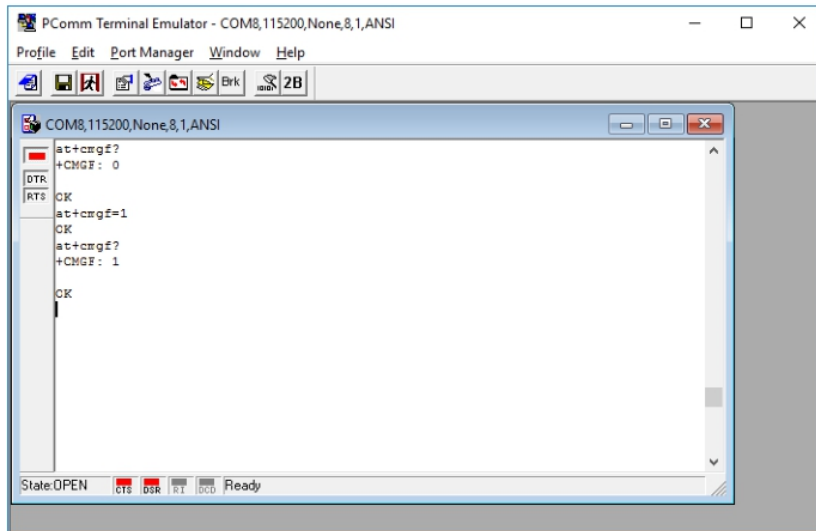

## Using MxTerm to Test the SMS Function

1. Run the MxTerm utility on your MC-1100 computer
2. Open a COM port (e.g., COM8).

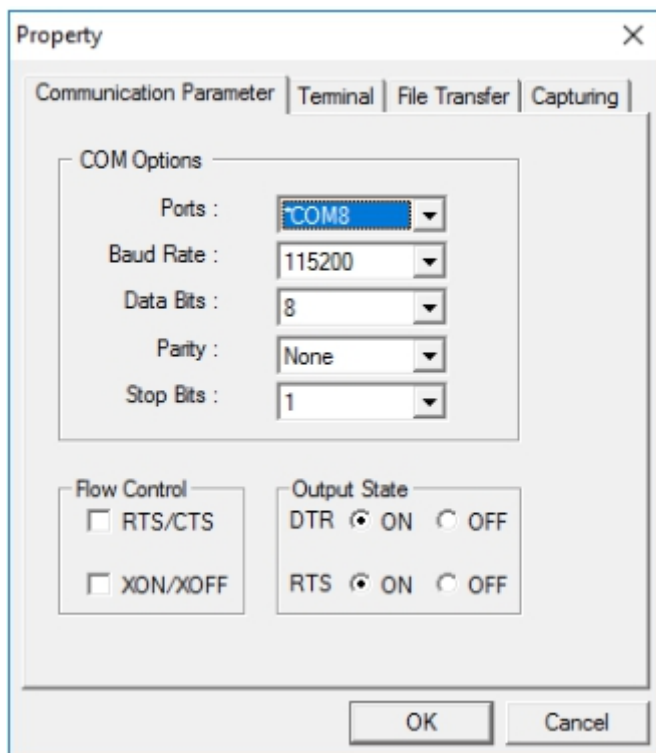

3. Enter `at+cmgs=<cell phone number>` and then enter the message you want to send.

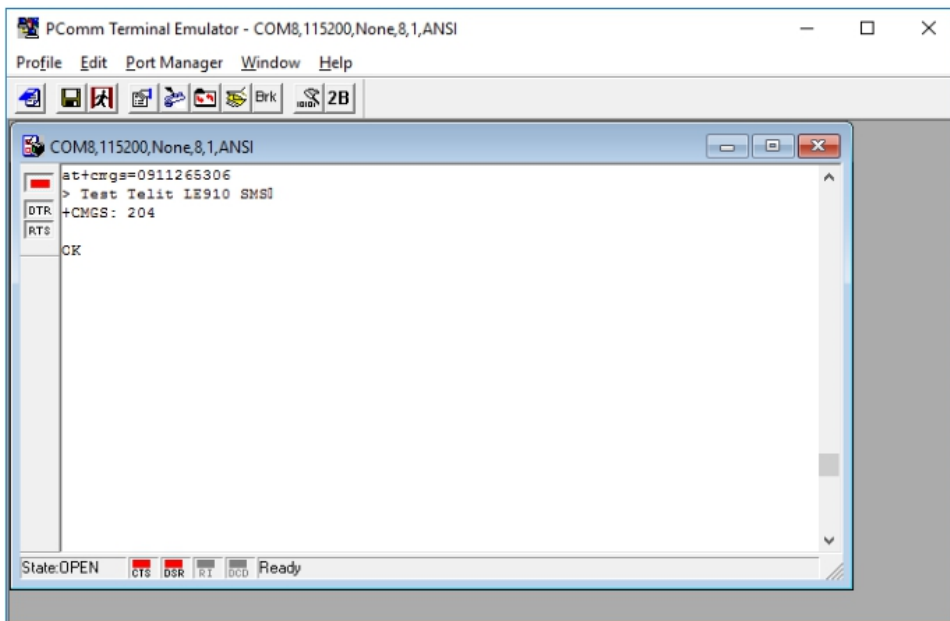

4. Confirm that the SMS message is delivered to the cell phone.

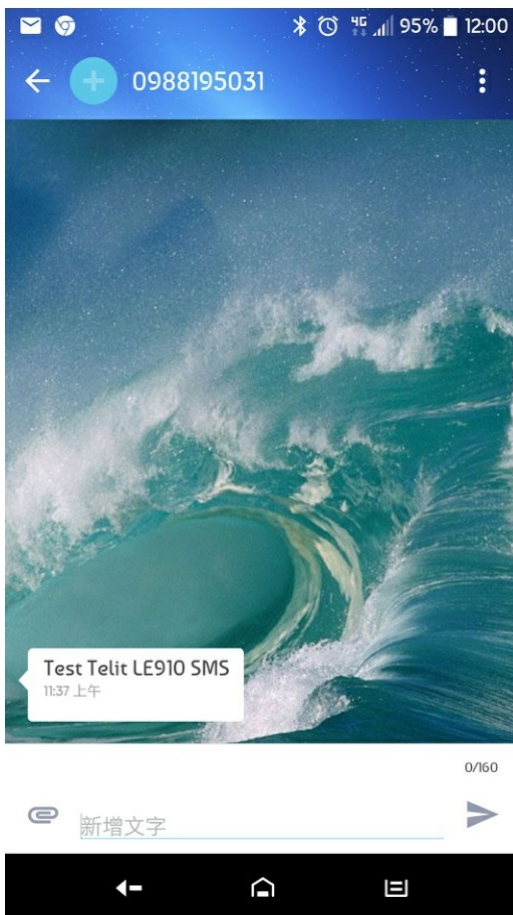

# Using a Sample Program to Test the SMS Function

1. Run the sample program **SendSMSByATCommand.exe**.

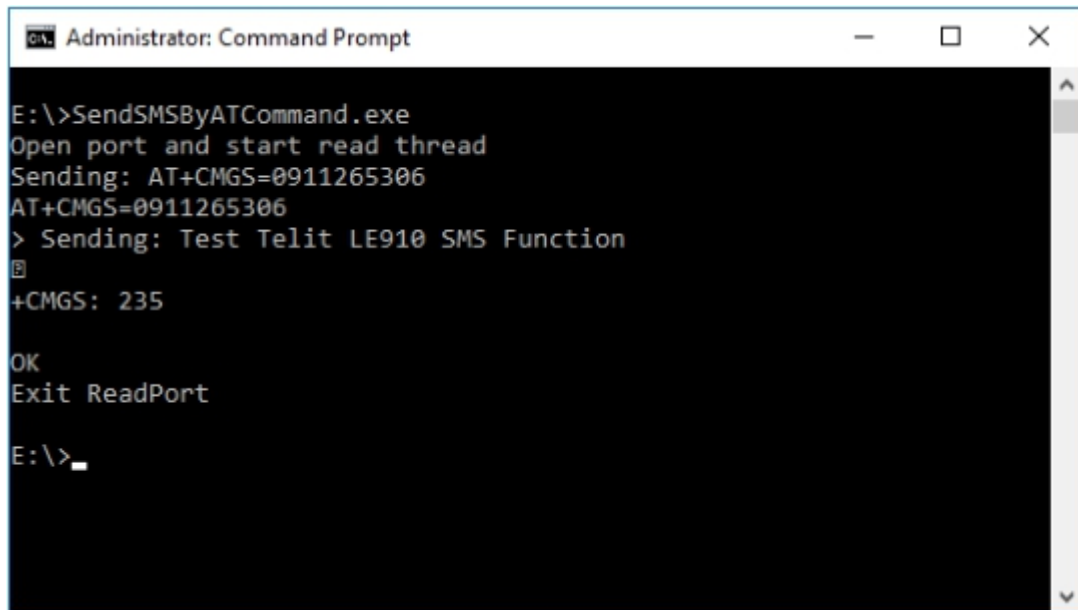

```
Administrator: Command Prompt
E:\>SendSMSByATCommand.exe
Open port and start read thread
Sending: AT+CMGS=0911265306
AT+CMGS=0911265306
> Sending: Test Telit LE910 SMS Function
+CMGS: 235
OK
Exit ReadPort
E:\>_
```

2. Enter the cell phone number and the SMS that you want to send.
3. Confirm that the SMS message is delivered to the cell phone.

