

AWK-4131 Hardware Installation Guide

Moxa AirWorks

Second Edition, June 2014

MOXA[®]

© 2014 Moxa Inc. All rights reserved.
Reproduction without permission is prohibited.

P/N: 1802041310011

Notes for the Reader



WARNING

Indicates that death or personal injury may occur if proper precautions are not taken.



ATTENTION

Indicates that possible damage to this product or your property may result if proper precautions are not taken.



NOTE

Highlights important information related to this product.

Package Checklist

Moxa's AWK-4131 is shipped with the following items. If any of these items is missing or damaged, please contact your customer service representative for assistance.

- AWK-4131
- 2 omni-directional antennas (5/2 dBi, N-type male, 2.4/5 GHz)
- Wall mounting kit (includes 2 supports)
- Field-installable power plug
- Field-installable M12 8-pin male plug for Ethernet
- Metal cap to cover M12 male DI/O connector
- Metal cap to cover RJ45 connector
- Meta cap to cover M30 SFP connector
- Documentation and software CD
- Quick installation guide (printed)
- Warranty card

Recommended SFP Accessories

SFP-1G series

- SFP-1GSXLC:
Small form factor pluggable transceiver with 1000BaseSX, LC, 0.5 km, 0 to 60°C
- SFP-1GSXLC-T:
Small form factor pluggable transceiver with 1000BaseSX, LC, 0.5 km, -20 to 75°C
- SFP-1GLSXLC:
Small form factor pluggable transceiver with 1000BaseLSX, LC, 2 km, 0 to 60°C
- SFP-1GLSXLC-T:
Small form factor pluggable transceiver with 1000BaseLSX, LC, 2 km, -40 to 85°C
- SFP-1GLXLC:
Small form factor pluggable transceiver with 1000BaseLX, LC, 10 km, 0 to 60°C
- SFP-1GLXLC-T:
Small form factor pluggable transceiver with 1000BaseLX, LC, 10 km, -40 to 85°C
- SFP-1GLHLC:
Small form factor pluggable transceiver with 1000BaseLH, LC, 30 km, 0 to 60°C
- SFP-1GLHLC-T:
Small form factor pluggable transceiver with 1000BaseLH, LC, 30 km, -40 to 85°C
- SFP-1GLHXLC:
Small form factor pluggable transceiver with 1000BaseLHX, LC, 40 km, 0 to 60°C
- SFP-1GLHXLC-T:
Small form factor pluggable transceiver with 1000BaseLHX, LC, 40 km, -40 to 85°C
- SFP-1GZXLC:
Small form factor pluggable transceiver with 1000BaseZX, LC, 80 km, 0 to 60°C
- SFP-1GZXLC-T:
Small form factor pluggable transceiver with 1000BaseZX, LC, 80 km, -40 to 85°C
- SFP-1GEZXLC:
Small form factor pluggable transceiver with 1000BaseEZX, LC, 110 km, 0 to 60°C
- SFP-1GEZXLC-120:
Small form factor pluggable transceiver with 1000BaseEZX, LC, 120 km, 0 to 60°C

NOTE The above items come with the AWK-4131 standard version. The package contents for customized versions may be different.

Panel Layout of the AWK-4131

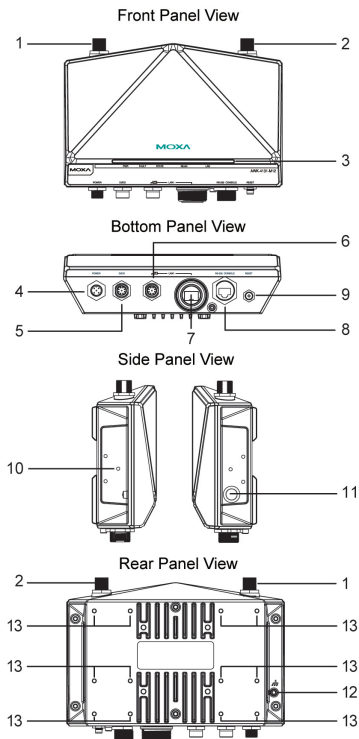

1. Main antenna A.
2. Main antenna B.
3. LEDs for PWR, FAULT, STATE, WLAN and LAN.
4. M12 A-coding connector for PWR1 and PWR2.
5. M12 8-pin male connector for DI/DO
6. M12 8-pin female connector for Ethernet port
7. SFP Port
8. RS-232 console port.
9. Reset button
10. Screw holes for wall mounting
11. Waterproof vent
12. Grounding screw (M8)
13. Screw holes for DIN-rail mounting



ATTENTION

Please DO NOT open or remove the vent **11**. The warranty will be invalid if the seal is removed.

All exposed connectors, including **1, 2, 4 - 9**, should be tightly covered by suitable caps when they are not in use.

Dimensions

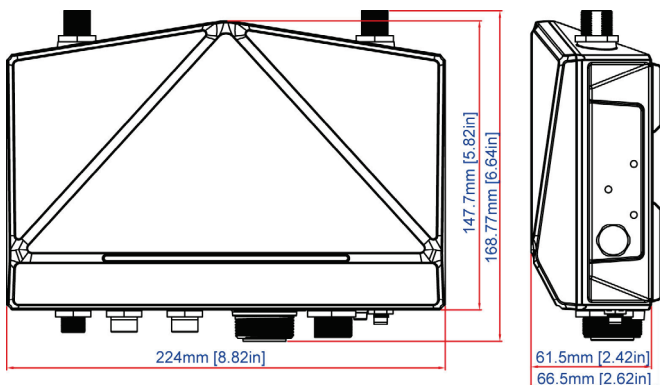

Attaching Antennas

The AWK-4131 includes two dual-band omni-directional antenna by default. Attach the antennas as illustrated below.

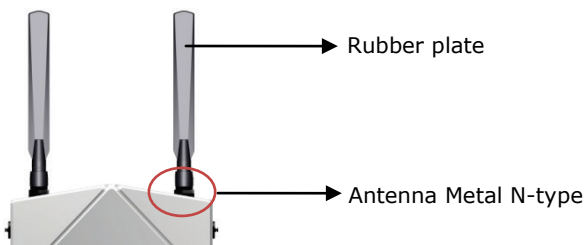

Step 1: Use your fingers and hold the antenna metal N-type connector.

Step 2: Screw the antenna N-type connector (male) onto the AWK-4131 device's N-type connector (female)



Caution

Do not hold the rubber plate to screw the antenna on to the AWK-4131 device.



ATTENTION

Use the antennas correctly: Use 2.4GHz antennas if the AWK-4131 operates in IEEE 802.11b/g/n. Use the 5GHz antennas for operations in IEEE802.11a/n. Make sure your antenna installation is within a safe area covered by a lightning protection or surge arrest system.

Wall Mounting

In most applications, wall mount provides an easier installation. You will find it quite easy to mount AWK-4131 on the wall, as illustrated below.

STEP 1:

Attach the wall-mounting kit with M4 screws, as shown in the diagram below.

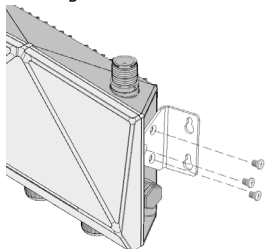

STEP 2:

Mounting the AWK-4131 on the wall requires 4 screws. Use the AWK-4131 device, with wall-mounting kit attached, as a guide to mark the correct locations of the 4 screws. The heads of the screws are recommended to be between 5.5mm and 8.5 mm in diameter, and the shafts should not be more than 5.0 mm in diameter, as shown in the figure.

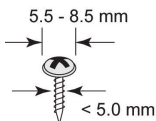

Do not screw the screws all the way in to the wall—leave a space of about 2 mm to allow room for sliding the wall-mounting kit between the wall and the screws.



ATTENTION

You can test the screw head and shank size by inserting the screw into one of the keyhole shaped apertures of the wall mounting plates before it is screwed into the wall.

STEP 3:

Once the screws are fixed into the wall, insert the four screw heads through the large opening of the keyhole-shaped apertures, and then slide the AWK-4131 downwards, as indicated to the right. Tighten the four screws for added stability.

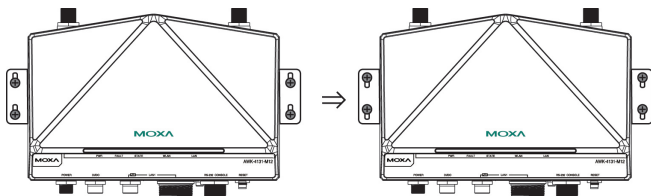

ATTENTION

To avoid environmental vibration or shock, you can consider a robust installation with four bigger screws, which the shafts are between 7.0 mm and 8.5 mm in diameter, and fix the AWK-4131 onto wall directly and tightly.

DIN-Rail Mounting (Optional)

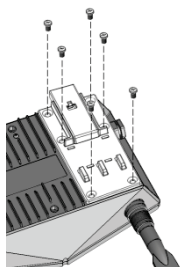

The DK-DC50131 die-cast metal kit can be bought separately, and enable easy and robust installation for the AWK-4131. A pair of DK-DC50131s is needed for DIN-Rail mounting. To install the DIN-Rail mounting kits, tightly attach the two DIN-Rail mounting kits on the rear panel of AWK-4131 with 12 screws. (6 screws for each kit)

To Install

STEP 1:

Use the recessed button on the spring-loaded bracket to lock it into position.

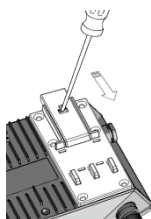

STEP 2:

Insert the top of the DIN-Rail into the slot just below the upper hook of the DIN-Rail mounting kit. Push the AWK-4131 toward the DIN-Rail until the DIN-Rail attachment bracket snaps into place.

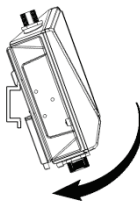

To Release

STEP 1:

Pull out the two spring-loaded brackets from the bottom until they are fixed in the "release" position.

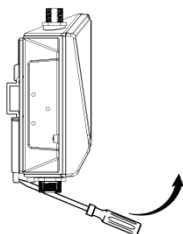

STEP 2:

Pull the AWK-4131 out and upward.

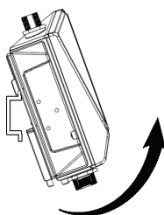

Wiring Requirements



WARNING

Safety First!

Be sure to disconnect the power cord before installing and/or wiring your Moxa AWK-4131.

Calculate the maximum possible current in each power wire and common wire. Observe all electrical codes dictating the maximum current allowable for each wire size. If the current goes above the maximum ratings, the wiring could overheat, causing serious damage to your equipment.

You should also pay attention to the following items:

- Use separate paths to route wiring for power and devices. If power wiring and device wiring paths must cross, make sure the wires are perpendicular at the intersection point.
NOTE: Do not run signal or communications wiring and power wiring in the same wire conduit. To avoid interference, wires with different signal characteristics should be routed separately.
- You can use the type of signal transmitted through a wire to determine which wires should be kept separate. The rule of thumb is that wiring with similar electrical characteristics can be bundled together.
- Keep input wiring and output wiring separate.
- It is strongly advised that you label wiring to all devices in the system when necessary.

Grounding Moxa AWK-4131

Grounding and wire routing help limit the effects of noise due to electromagnetic interference (EMI). Run the ground connection from the ground screw to the grounding surface prior to connecting devices.



ATTENTION

This product is intended to be mounted to a well-grounded mounting surface, such as a metal panel. There must be no potential difference between two ground potentials, otherwise there is a risk that the device could be destroyed.

Wiring the Redundant Power Inputs

The AWK-4131 must be connected to a power-over-Ethernet (PoE) IEEE 802.3af compliant power source or an IEC60950 compliant limited power source. When AWK-4131 is powered via DC power, the M12 A-coding connector on the bottom panel is used for the AWK-4131's two redundant inputs. The pin assignment is shown below:

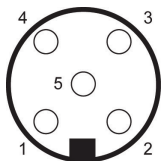

Pin	Power Input
1	V1+
2	V2+
3	V1-
4	V2-
5	GND



ATTENTION

This product is intended to be supplied by a Listed Power Unit marked "Class 2" or "LPS" and rated O/P: 12 to 48 VDC, 890mA (max.), 25°C.

Make sure External Power Adaptor (includes power cords and plug assemblies) provided with the unit is certified and suitable for use in your country.

Before connecting the AWK-4131 to the DC power inputs, make sure the DC power source voltage is stable.



ATTENTION

Do not use the PoE Injector. Instead, please use an IEEE802.3af or IEEE802.3at compliant PSE (Power Sourcing Equipment) for PoE (Power over Ethernet) device.

Wiring the Digital Inputs and Relay Contact

(Digital Output)

The AWK-4131 has two sets of digital input—DI1 and DI2. Each DI comprises two contacts of the 8-pin M12 connector on the AWK-4131's bottom panel. These two digital inputs can be connected to digital-output-enabled sensors for on-site status monitoring.

The AWK-4131 also has one relay output, which consists of the two contacts. These relay contacts are used to detect user-configured events. The two wires attached to the Relay contacts form an open circuit when a user-configured event is triggered. If a user-configured event does not occur, the Relay circuit will be closed.

A field-installable plug, **M12A-8PF-IP67**, is recommended for connecting the AWK-4131's DIs and relay.

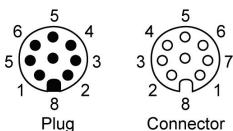

Pin	Signal
1	Relay
2	
3	DI1 I1
4	DI1 COM_1
5	DI2 I2
6	DI2 COM_2
7	Reserved
8	

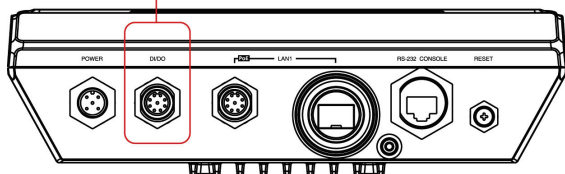

Communication Connections

Connecting the Data Lines

10/100/1000BaseT(X) Ethernet Port Connection

AWK-4131 has 10/100/1000BaseT(X) Ethernet ports (8-pin shielded M12 connector with A coding). The 10/100/1000BaseT(X) ports located on the AWK-4131's bottom panel are used to connect to Ethernet-enabled devices. Below we show pinouts for both MDI (NIC-type) ports and MDI-X (HUB/Switch-type) ports.

Pinouts for the 10/100/1000BaseT(X) M12 (8-pin) Port

PIN	Con.
1	TRD3+
2	TRD4+
3	TRD4-
4	TRD1-
5	TRD2+
6	TRD1+
7	TRD3-
8	TRD2-

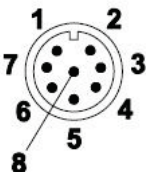

ATTENTION

To ensure the IP68-rated connectivity, you must use a waterproof housing during any communication activities. An IP68-rated field installable plug, which is attached in AWK-4131's accessory pack, may be needed in this case. The installation guide is shown below:

Ethernet M12 Plug

Dimensions (unit: mm)

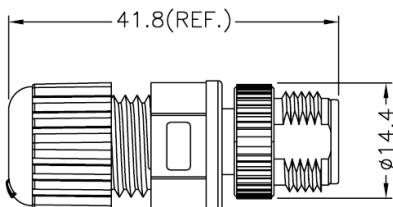

Installation

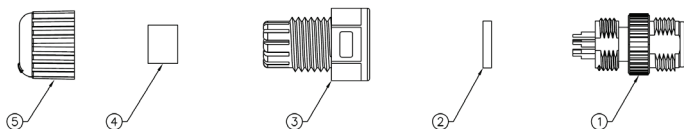

1. Refer to the pin assignment and solder wires with ①;
2. Then assemble ②, ③, ④, and ⑤ in order;
3. Test the plug to ensure the quality.

RS-232 Connection

The AWK-4131 has one RS-232 (8-pin RJ45) console port located on the bottom panel. Use either an RJ45-to-DB9 or RJ45-to-DB25 cable to connect the Moxa AWK-4131's console port to your PC's COM port. You may then use a console terminal program to access the AWK-4131 for console configuration.

Console Pinouts for 10-pin or 8-pin RJ45

10-Pin	Description	8-Pin
1	-----	
2	DSR	1
3	RTS	2
4	GND	3
5	TxD	4
6	RxD	5
7	DCD	6
8	CTS	7
9	DTR	8
10	-----	

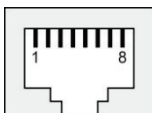

- NOTE**
1. The pin numbers for male DB9 and DB25 connectors, and hole numbers for female DB9 and DB25 connectors are labeled on the connector. However, the numbers are typically quite small, so you may need to use a magnifying glass to see the numbers clearly.
 2. The pin numbers for both 8-pin and 10-pin RJ45 connectors (and ports) are typically not labeled on the connector (or port). Refer to the Pinout diagram above to see how RJ45 pins are numbered.

LED Indicators

The front panel of the Moxa AWK-4131 contains several LED indicators. The function of each LED is described in the table below.

LED	Color	State	Description
Front Panel LED Indicators (System)			
PWR	Green	On	Power is being supplied (from power input 1 or 2, or PoE).
		Off	Power is not being supplied
FAULT	Red	Blink (slow)	Cannot get an IP address from the DHCP server (interval: 1 sec)
		Blink (fast)	IP address conflict (interval: 0.5 sec)
		Off	Error condition does not exist.
WLAN	Green	On	WLAN functions is in Client/Slave mode.
		Blink	WLAN's data communication is run in Client/Slave mode
		Off	WLAN is not in use or not working properly
	Amber	On	WLAN functions is in AP/Bridge mode.
		Blink	WLAN's data communication is run in AP/Master mode
		Off	WLAN is not in use or not working properly.
LAN	Green	On	LAN port's 1000Mbps link is active .
		Blink	Data is being transmitted at 1000 Mbps
		Off	LAN port's 1000Mbps link is inactive .
	Amber	On	LAN port's 10/100Mbps link is active .
		Blink	Data is being transmitted at 10/100 Mbps
		Off	LAN port's 10/100Mbps link is inactive .

Specifications

WLAN Interface	
Standards	IEEE 802.11a/b/g/n for Wireless LAN IEEE 802.11i for Wireless Security IEEE 802.3 for 10BaseT IEEE 802.3u for 100BaseTX IEEE 802.3ab for 1000BaseT IEEE 802.3af for Power-over-Ethernet IEEE 802.1D for Spanning Tree Protocol IEEE 802.1w for Rapid STP IEEE 802.1Q VLAN
Spread Spectrum and Modulation (typical)	DSSS with DBPSK, DQPSK, CCK OFDM with BPSK, QPSK, 16QAM, 64QAM 802.11b: <ul style="list-style-type: none"> • CCK @ 11/5.5 Mbps • DQPSK @ 2 Mbps • DBPSK @ 1 Mbps 802.11a/g: <ul style="list-style-type: none"> • 64QAM @ 54/48 Mbps • 16QAM @ 36/24 Mbps • QPSK @ 18/12 Mbps • BPSK @ 9/6 Mbps 802.11n: <ul style="list-style-type: none"> • 64QAM @ 300 bps to BPSK @ 6.5 Mbps

	(multiple rates supported)
Operating Channels (central frequency)	<p>US:</p> <ul style="list-style-type: none"> • 2.412 to 2.462 GHz (11 channels) • 5.18 to 5.24 GHz (4 channels) <p>EU:</p> <ul style="list-style-type: none"> • 2.412 to 2.472 GHz (13 channels) • 5.18 to 5.24 GHz (4 channels) <p>JP:</p> <ul style="list-style-type: none"> • 2.412 to 2.484 GHz (14 channels, channel 14 only support DSSS) • 5.18 to 5.24 GHz (4 channels for W52)
Security	<p>SSID broadcast enable/disable</p> <p>Firewall for MAC/IP/Protocol/Port-based filtering</p> <p>64-bit and 128-bit WEP encryption,</p> <p>WPA/WPA2-Personal and Enterprise (IEEE 802.1X/RADIUS · TKIP and AES)</p>
Transmission Rates	<p>802.11b: 1, 2, 5.5, 11 Mbps</p> <p>802.11a/g: 6, 9, 12, 18, 24, 36, 48, 54 Mbps</p> <p>802.11n: 6 to 300 Mbps (multiple rates supported)</p>
TX Transmit Power	<p>2.4GHz</p> <p>802.11b:</p> <ul style="list-style-type: none"> • Typ. 18±1.5 dBm @ 1 to 11 Mbps <p>802.11g:</p> <ul style="list-style-type: none"> • Typ. 18±1.5 dBm @ 6 to 24 Mbps • Typ. 17±1.5 dBm @ 36 to 48 Mbps • Typ. 15±1.5 dBm @ 54 Mbps <p>802.11n:</p> <ul style="list-style-type: none"> • MCS15 20 MHz: Typ. 14 dBm (± 1.5 dBm) • MCS15 40 MHz: Typ. 13 dBm (± -1.5 dBm) <p>5GHz</p> <p>802.11a:</p> <ul style="list-style-type: none"> • Typ. 17±1.5 dBm @ 6 to 24 Mbps • Typ. 16±1.5 dBm @ 36 to 48 Mbps • Typ. 14±1.5 dBm @ 54 Mbps <p>802.11n:</p> <ul style="list-style-type: none"> • MCS15 20 MHz: Typ. 13 dBm (± 1.5 dBm) • MCS15 40 MHz: Typ. 12 dBm (± 1.5 dBm)
RX Sensitivity	<p>2.4GHz</p> <p>802.11b:</p> <ul style="list-style-type: none"> • -92 dBm @ 1 Mbps • -90 dBm @ 2 Mbps • -88 dBm @ 5.5 Mbps • -84 dBm @ 11 Mbps <p>802.11g:</p> <ul style="list-style-type: none"> • -87 dBm @ 6 Mbps • -86 dBm @ 9 Mbps • -85 dBm @ 12 Mbps • -82 dBm @ 18 Mbps • -80 dBm @ 24 Mbps • -76 dBm @ 36 Mbps • -72 dBm @ 48 Mbps • -70 dBm @ 54 Mbps <p>802.11n:</p> <ul style="list-style-type: none"> • -68 dBm @ MCS15 40 MHz

	<ul style="list-style-type: none"> -70 dBm @ MCS7 40 MHz -69 dBm @ MCS15 20 MHz, -71 dBm @ MCS7 20 MHz 802.11a: <ul style="list-style-type: none"> -87 dBm @ 6 Mbps -86 dBm @ 9 Mbps -85 dBm @ 12 Mbps -82 dBm @ 18 Mbps -80 dBm @ 24 Mbps -76 dBm @ 36 Mbps -72 dBm @ 48 Mbps -70 dBm @ 54 Mbps 802.11n: <ul style="list-style-type: none"> -68 dBm @ MCS15 40 MHz -70 dBm @ MCS7 40 MHz -69 dBm @ MCS15 20 MHz -71 dBm @ MCS7 20 MHz
Protocol Support	
General Protocols	Proxy ARP, DNS, HTTP, HTTPS, IP, ICMP, SNMP, TCP, UDP, RADIUS, SNMP, PPPoE, DHCP, LLDP
AP-only Protocols	ARP, BOOTP, DHCP, dynamic VLAN-Tags for 802.1X-Clients, STP/RSTP (IEEE 802.1D/w)
Interface	
Default Antennas	2 dual-band omni-directional antennas, 5 dBi at 2.4 GHz, 2 dBi at 5 GHz, N-type (male)
Connector for External Antennas	N-type (female)
Ethernet Ports	1, 10/100/1000BaseT(X), auto negotiation speed (M12 female type)
Fiber Ports	1, 1000BaseSFP slot
Console Port	RS-232 (waterproof RJ45-type)
Reset	Present
LED Indicators	PWR, FAULT, STATE, WLAN, LAN
Alarm Contact	1 relay output with current carrying capacity of 1 A @ 24 VDC, M12 male type
Digital Inputs	2 electrically isolated inputs , M12 male type +13 to +30 V for state "1" +3 to -30 V for state "0" Max. input current: 8 mA
Physical Characteristics	
Housing	Metal, providing IP68 protection
Weight	1.8kg
Dimensions	224 x 147.7 x 64.5 mm (8.82 x 5.82 x 2.54 in)
Installation	Wall mounting (standard), DIN-Rail mounting (optional), pole mounting (optional)
Environmental Limits	
Operating Temperature	-40 to 75°C (-40 to 167°F)
Storage Temperature	-40 to 85°C (-40 to 185°F)

Ambient Relative Humidity	5% to 100% (non-condensing)
Power Requirements	
Input Voltage	12 to 48 VDC, redundant dual DC power inputs or 48 VDC Power-over-Ethernet (IEEE 802.3af compliant)
Connector	M12 connector with A-coding
Power Consumption	12 to 48 VDC, 890mA (max.)
Reverse Polarity Protection	Present
Standards and Certifications	
Safety	UL 60950-1, EN 60950-1
EMC	EN 301 489-1/17; FCC Part 15, Subpart B; EN 55022/55024
Radio	EN 300 328, EN 301 893, TELEC
Note: Check Moxa's website for the most up-to-date certification status.	
Reliability	
MTBF	367,406 hrs
Warranty	
Warranty Period	5 years
Details	See www.moxa.com/support/warranty.aspx



ATTENTION

This device complies with part 15 of the FCC Rules. Operation is subject to the following two conditions:

1. This device may not cause harmful interference, and
2. This device must accept any interference received, including interference that may cause undesired operation.



ATTENTION

Do not locate the antenna near overhead power lines or other electric light or power circuits, or where it can come into contact with such circuits. When installing the antenna. Take extreme care not to come into contact with such circuits, because they may cause serious injury or death. For proper installation and grounding of the antenna. please refer to national and local codes (for example, U.S.:NFPA 70, National Electrical Code, Article 810, Canada: Canadian Electrical Code, Section 54).

NOTE For installation flexibility, either the A antenna or the B antenna may be selected for use. Make sure the antenna connection matches the antenna configured in the AWK-4131 interface. To protect the connectors and RF module, all radio ports should be terminated by either an antenna or a terminator. The use of the resistive terminator for terminating the unused antenna port is strongly recommended.



ATTENTION

To ensure the IP68-rated connectivity, you must use a waterproof housing during any communication activities. An IP68-rated field installable plug, which is attached in AWK- 4000 and AWK-6000 series' accessory pack, may be needed in this case. Please reference product's installation guide.

Technical Support Contact Information **www.moxa.com/support**

Moxa Americas:

Toll-free: 1-888-669-2872

Tel: 1-714-528-6777

Fax: 1-714-528-6778

Moxa China (Shanghai office):

Toll-free: 800-820-5036

Tel: +86-21-5258-9955

Fax: +86-21-5258-5505

Moxa Europe:

Tel: +49-89-3 70 03 99-0

Fax: +49-89-3 70 03 99-99

Moxa Asia-Pacific:

Tel: +886-2-8919-1230

Fax: +886-2-8919-1231