

PT-510 Series Quick Installation Guide

Moxa PowerTrans Switch

Edition 5.0, February 2017

Technical Support Contact Information www.moxa.com/support

Moxa Americas:

Toll-free: 1-888-669-2872

Tel: 1-714-528-6777

Fax: 1-714-528-6778

Moxa China (Shanghai office):

Toll-free: 800-820-5036

Tel: +86-21-5258-9955

Fax: +86-21-5258-5505

Moxa Europe:

Tel: +49-89-3 70 03 99-0

Fax: +49-89-3 70 03 99-99

Moxa Asia-Pacific:

Tel: +886-2-8919-1230

Fax: +886-2-8919-1231

Moxa India:

Tel: +91-80-4172-9088

Fax: +91-80-4132-1045

MOXA®

© 2017 Moxa Inc. All rights reserved.

P/N: 1802005102013



Package Checklist

Moxa's PT-510 PowerTrans switch is shipped with the following items. If any of these items is missing or damaged, please contact your customer service representative for assistance.

- PT-510 PowerTrans switch
- RJ45 to DB9 console port cable
- DIN-Rail Kit or wall mount plates (optional)
- 1 grounding cable
- Protective caps for unused ports
- Documentation and software CD
- Quick installation guide (printed)
- Warranty card

Panel Layout of the PT-510

PT-510
Front Panel View

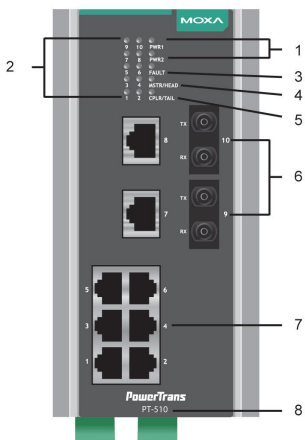

1. Power input PWR1/PWR2(DC model only) LED
2. LEDs for ports 1 to 10
3. Fault LED
4. MSTR/HEAD: LED indicator
5. CPLR/TAIL: LED indicator
6. 100BaseFX ports (SC/ST/LC/MTRJ)
7. 10/100BaseT(X) ports
8. Model Name
9. Terminal block for power input
10. Screw hole for grounding cable
11. Terminal block for DI and Relay 1
12. Console port
13. Screw hole for wall mounting kit
14. Screw hole for DIN-Rail kit
15. DIN-Rail kit

Bottom Panel View

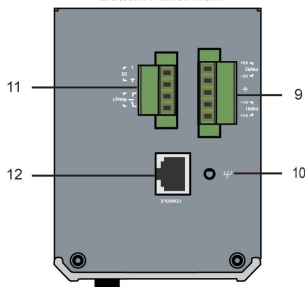

Rear Panel View

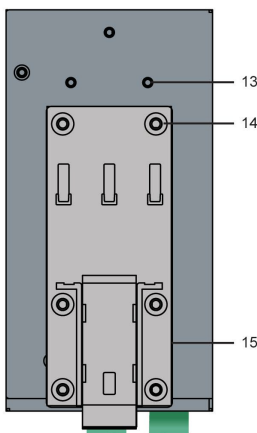

Mounting Dimensions (unit = mm)

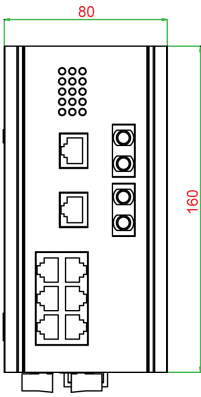

Front View

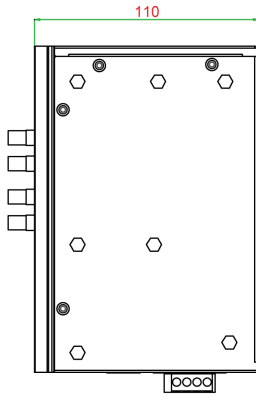

Side View

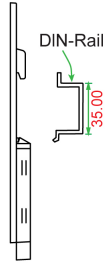

DIN-Rail Kit

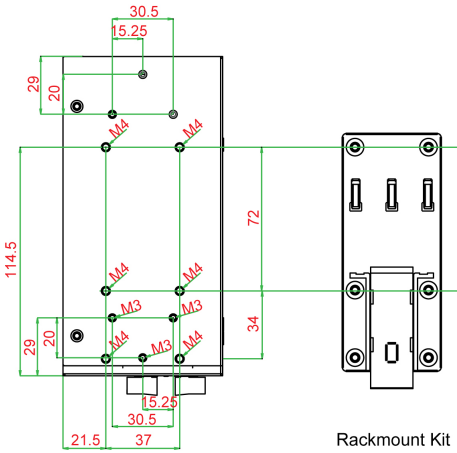

Rackmount Kit

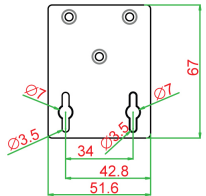
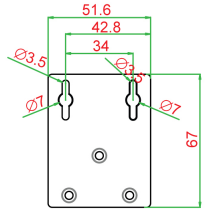

Wallmount Kit

DIN-Rail Mounting

The aluminum DIN-Rail attachment plate should already be fixed to the back panel of the PT-510 when you take it out of the box. If you need to reattach the DIN-Rail attachment plate to the PT-510, make sure the stiff metal spring is situated towards the top as shown in the figures below.

STEP 1: If the spring-loaded bracket is locked in place, push the recessed button to release it. Once released, you should feel some resistance from the spring as you slide the bracket up and down a few millimeters in each direction.

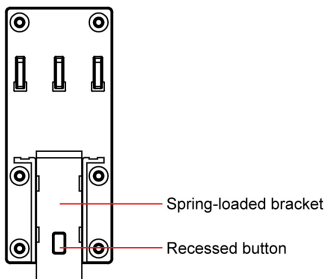

STEP 2: Insert the top of the DIN-Rail into the top slots on the DIN-Rail attachment plate.

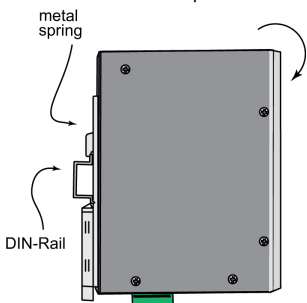

STEP 3: The DIN-Rail attachment unit will snap into place as shown in the following illustration.

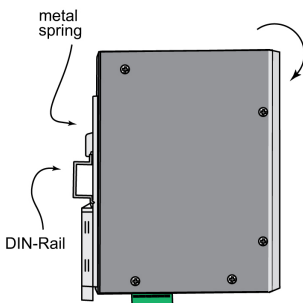

To remove the Moxa PT-510 switch from the DIN-Rail, use a screwdriver to push down the spring-loaded bracket until it locks in place, as shown in the following diagram. Next, rotate the bottom of the switch upwards and then remove the switch from the DIN-Rail.

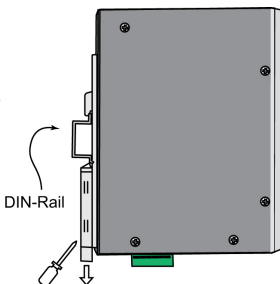

Wall Mounting (optional)

For added convenience, the PT-510 can be wall mounted as illustrated below.

STEP 1: Remove the aluminum DIN-Rail attachment plate from the PT-510's rear panel, and then attach the wall mount plates with 6 M3 screws, as shown on the right.

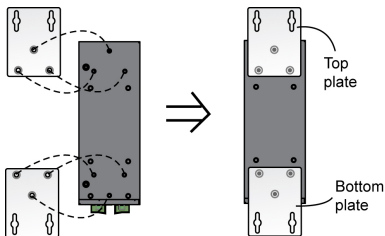

STEP 2: Mounting the PT-510 to a wall requires 4 screws. Use the PT-510, with wall mount plates attached, as a guide to mark the correct locations for the 4 screws. The heads of the screws should be less than 6.0 mm in diameter, and the shafts should be less than 3.5 mm in diameter, as shown on the right.

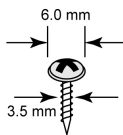

NOTE Test the screw's head and shank size by inserting the screw into one of the keyhole-shaped apertures of the wall mounting plates before screwing it into the wall.

DO NOT screw the screws all the way in—leave a space of about 2 mm to allow room for sliding the wall mount panel between the wall and the screws.

STEP 3: After the screws are fixed into the wall, insert the four screw heads through the large opening of the keyhole-shaped apertures, and then slide the PT-510 downwards. Tighten the 4 screws for added stability.

Wiring Requirements



WARNING

Safety First!

Be sure the power cord is disconnected before installing and/or wiring your PT-510.

Calculate the maximum possible current in each power wire and common wire. Observe all electrical codes dictating the maximum current allowed for each wire size. If the current goes above the maximum rating, the wiring could overheat, causing serious damage to your equipment.

Please read and follow these **important guidelines**:

- Use separate paths to route wiring for power and devices. If power wiring and device wiring paths must cross, make sure the wires are perpendicular at the intersection point.
NOTE: Do not run signal or communications wiring and power wiring in the same wire conduit. To avoid interference, wires with different signal characteristics should be routed separately.
- You can use the type of signal transmitted through a wire to determine which wires should be kept separate. As a rule of thumb, wiring with similar electrical characteristics can be bundled together.
- Keep input wiring and output wiring separate.
- It is strongly advised that you label wiring to all devices in the system.

Grounding the PowerTrans Switch

Grounding and wire routing help limit the effects of noise due to electromagnetic interference (EMI). Run the ground wire from the grounding screw to the grounding surface prior to connecting devices.



ATTENTION

Before powering on the PT-510 (24/48 VDC models), make sure that the grounding cable is secured between the grounding screw and ground for surge protection on the terminal block. Ground for surge protection is on terminal 3 of the terminal block as shown below.

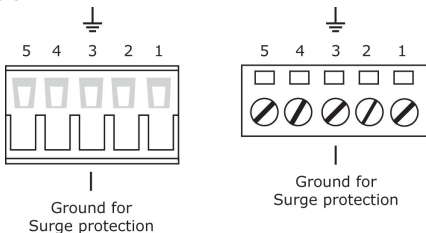

ATTENTION

This product is to be mounted to a well-grounded mounting surface, such as a metal panel.



ATTENTION

For dielectric strength (HIPOT) test, users must remove the grounding cable secured between the grounding screw and ground for surge protection located at terminal 3 of the terminal block to avoid damage.

Wiring the Relay Contact

The PT-510 has one set of relay output—relay 1. The relay contact consists of two contacts of the terminal block on the PT-510's bottom panel. Refer to the next section for detailed instructions on how to connect the wires to the terminal block connector, and how to attach the terminal block connector to the terminal block receptor.

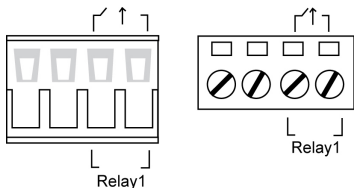

The fault circuit will open if:

1. A relay warning event is triggered, OR
2. The PT-510 is the Master of this Turbo Ring, and the Turbo Ring is broken, OR
3. Start-up failure.

If none of these three conditions is met, the fault circuit will remain closed.

Wiring the Redundant Power Inputs (24/48 VDC models)

The PT-510 (24/48 VDC models) unit has two sets of power inputs – power input 1 and power input 2. Top and front views of one of the terminal block connectors are shown below.

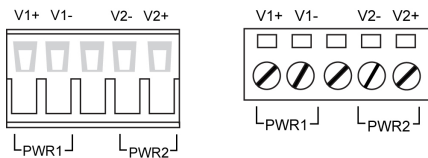

Take the following steps to wire the redundant power inputs:

STEP 1: Insert the negative/positive DC wires into the V-/V+ terminals and insert the AC power wires into the L and N terminals.

STEP 2: To keep the wires from pulling loose, use a small flat-blade screwdriver to tighten the wire-clamp screws on the front of the terminal block connector.

STEP 3: Insert the plastic terminal block connector prongs into the terminal block receptor, which is located on the PT's bottom panel.



ATTENTION

Before connecting the PT to the DC power inputs, make sure the DC power source voltage is stable.

Wiring the Power Input (110/220 VDC/VAC model)

The PT-510 unit (110/220 VDC/VAC model) has one set of power input – Pin 1 (Neutral) and Pin5 (Line). To insert the terminal block connector prongs into the terminal block receptor on this PT-510 unit properly. Please take the following steps to wire the power input. Top and front views of one of the terminal block connectors are also shown below.

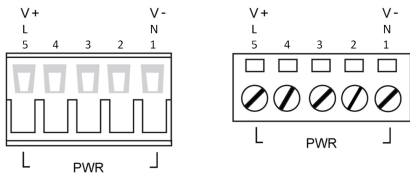

Take the following steps to wire the power input:

STEP 1: Insert the Neutral/Line AC or Negative/Positive DC wires into the terminals (Terminal 1 for Neutral/Negative and Terminal 5 for Line/Positive) of the terminal block connector.

STEP 2: To keep the AC or DC wires from pulling loose, use a small flat-blade screwdriver to tighten the wire-clamp screws on the front of the terminal block connector.

STEP 3: Insert the plastic terminal block connector prongs into the terminal block receptor, which is located on the PT's bottom panel.

NOTE The PT-510 unit (110/220 VDC/VAC model) has the reverse protection mechanism for 110/220 VDC input.

 **ATTENTION**
Before connecting the PT to the DC power inputs, make sure the DC power source voltage is stable.

Wiring the Digital Inputs

The PT-510 unit has one set of digital input, DI 1. The DI consists of two contacts from the 4-pin terminal block connector on the PT's bottom panel. The remaining contacts are used for the PT's Relay 1. Top and front views of one of the terminal block connectors are shown below.

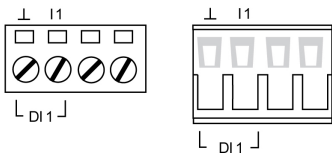

Take the following steps to wire the digital input:

STEP 1: Insert the negative (ground)/positive DI wires into the $-/I1$ terminals.

STEP 2: To keep the DI wires from pulling loose, use a small flat-blade screwdriver to tighten the wire-clamp screws on the front of the terminal block connector.

STEP 3: Insert the plastic terminal block connector prongs into the terminal block receptor, which is located on the PT-510's bottom panel.

Pin Assignments

PT-510 models have six 10/100BaseT(X) Ethernet ports, and two 100BaseFX (SC/ST/LC/MTRJ-type connector) fiber ports.

10/100BaseT(X) Ethernet Port Connection

The 10/100BaseT(X) ports located on PT's front panel are used to connect to Ethernet-enabled devices.

Next, we show pinouts for both MDI (NIC-type) ports and MDI-X (HUB/Switch-type) ports, and also show cable wiring diagrams for straight-through and cross-over Ethernet cables.

RJ45 (8-pin) to RJ45 (8-pin) Straight-Through Cable Wiring

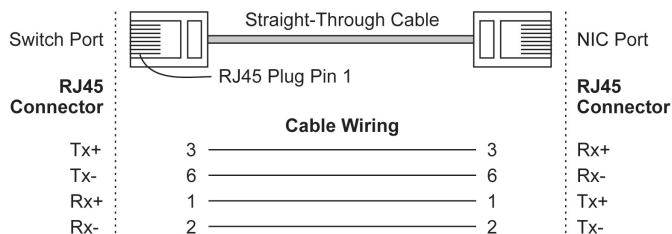

RJ45 (8-pin) to RJ45 (8-pin) Cross-Over Cable Wiring

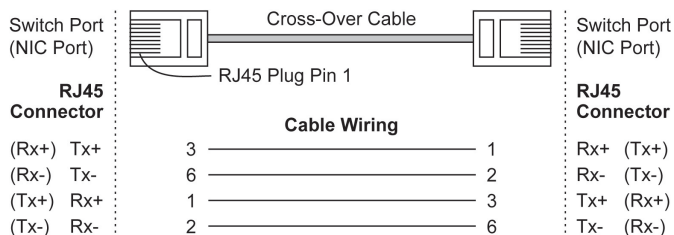

100BaseFX Ethernet Port Connection

When connecting device 1 to device 2, remember to connect the Tx (transmit) port of device 1 to the Rx (receive) port of device 2, and the Rx (receive) port of device 1 to the Tx (transmit) port of device 2. If you make your own cable, we suggest labeling the two sides of the same line with the same letter (A-to-A and B-to-B, as shown below, or A1-to-A2 and B1-to-B2).

SC-Port Pinouts

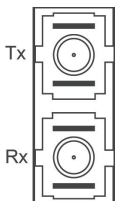

SC-Port to SC-Port Cable Wiring

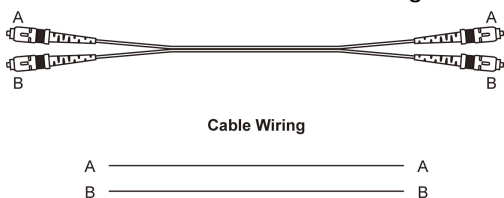

ST-Port Pinouts



ST-Port to ST-Port Cable Wiring



Cable Wiring

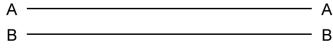

ATTENTION

This is a Class 1 Laser/LED product. To avoid causing serious damage to your eyes, do not stare directly into the Laser Beam.

Front Panel LEDs

The PT-510's front panel has five LED indicators, refer to the following table for details.

LED	Color	State	Description
PWR1	AMBER	On	Power is being supplied to power input PWR1.
		Off	Power is not being supplied to power input PWR1.
PWR2 (DC model)	AMBER	On	Power is being supplied to power input PWR2.
		Off	Power is not being supplied to power input PWR2.
Ports 1 to 10	GREEN	On	Port's 100 Mbps link is active.
		Off	Port's link is inactive.
	AMBER	On	Port's 10 Mbps link is active.
		Off	Port's link is inactive.
FAULT	RED	On	1. A relay warning event is triggered, or 2. The PT switch is the Master of this Turbo Ring, and the Turbo Ring is broken, or 3. Start-up fails
		Off	When a relay warning event is not triggered.
MSTR/HEAD	GREEN	On	When the PT switch is set as the Master of the Turbo Ring, or as the Head of the Turbo Chain.
		Blinking	The PT switch has become the Ring Master of the Turbo Ring, or the Head of the Turbo Chain, after the Turbo Ring or the Turbo Chain is down.
		Off	The PT switch has become the Ring Master of the Turbo Ring, or the Head of the Turbo Chain, after the Turbo Ring or the Turbo Chain is down.

LED	Color	State	Description
CPLR/TAIL	GREEN	On	When the PT switch coupling function is enabled to form a back-up path, or when the PT is set as the Tail of the Turbo Chain.
		Blinking	When the Turbo Chain is down.
		Off	When the PT switch disables the coupling function, or is set as a Member of the Turbo Chain.

Auto MDI /MDI-X Connection

The Auto MDI/MDI-X function allows users to connect the PT-510's 10/100BaseTX ports to any type of Ethernet device using either a *straight-through* cable or *cross-over* cable.

Fiber Ports

The fiber ports are factory-built as either multi-mode/single-mode SC/ST/LC connectors or multi-mode MTRJ connectors. You should use fiber cables that have SC/ST/LC/MTRJ connectors at both ends. When plugging the connector into the port, make sure the slider guide is positioned to the right such that it fits snugly into the port.

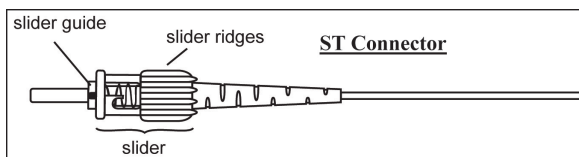
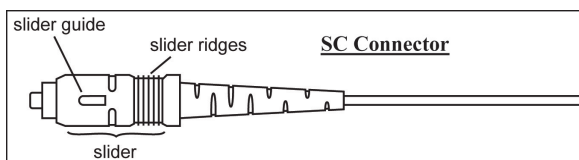

Specifications

Technology	
Standards	IEEE802.3, 802.3u, 802.3x, 802.1D, 802.1w, 802.1Q, 802.1p, 802.1X, 802.3ad
Protocols	IGMPv1/v2, GVRP, SNMPv1/v2c/v3, DHCP Server/Client, BootP, TFTP, SNTP, SMTP, RARP, GMRP, LACP, RMON, HTTP, HTTPS, Telnet, Syslog, DHCP Option 66/67/82, SSH, SNMP Inform, Modbus/TCP, LLDP, IEEE 1588 PTP, IPv6
MIB	MIB-II, Ethernet-Like MIB, P-BRIDGE MIB, Q-BRIDGE MIB, Bridge MIB, RSTP MIB, RMON MIB Group 1,2,3,9
Forwarding and Filtering Rate	148810 pps
Processing Type	Store and Forward
Flow Control	IEEE802.3x flow control, back pressure flow control

Interface			
RJ45 Ports	10/100BaseT(X) auto negotiation speed, F/H duplex mode, and auto MDI/MDI-X connection		
Fiber Ports	100BaseFX ports (SC/ST /LC/MTRJ connector)		
Console	RS-232 (RJ45)		
LED Indicators	PWR1, PWR2, FAULT, MSTR/HEAD and CPLR/TAIL		
Relay Contact	One relay output with current carrying capacity of 1A @ 24 VDC		
Digital Input	One input with the same ground, but electrically isolated from the electronics <ul style="list-style-type: none"> • For state "1": +13 to +30V • For state "0": -30 to +3V • Max. input current: 8 mA 		
Optical Fiber:			
	Multi-mode	Single mode	Single mode, 80 km
Wavelength	1300 nm	1310 nm	1550 nm
Max. Tx	-10 dBm	0 dBm	0 dBm
Min. Tx	-20 dBm	-5 dBm	-5 dBm
Rx Sensitivity	-32 dBm	-34 dBm	-34 dBm
Link Budget	12 dB	29 dB	29 dB
Typical Distance	5 km ^a 4 km ^b	40 km ^c	80 km ^d
Saturation	-6 dBm	-3 dBm	-3 dBm
a. using [50/125 μm, 800 MHz*km] cable b. using [62.5/125 μm, 500 MHz*km] cable c. sing [9/125 μm, 3.5 PS/(nm*km)] cable d. using [9/125 μm, 19 PS/(nm*km)] cable			
Power			
Input Voltage	<ul style="list-style-type: none"> • 24 VDC (18 to 36 V) isolated power and redundant power inputs • 48 VDC (36 to 60 V) isolated power and redundant power inputs • 110/220 VDC/VAC (88 to 300 VDC, 85 to 264 VAC) isolated power 		
Input Current (@24V)	Max. 24 VDC, 425 mA Max. 48 VDC, 190 mA Max. 110/220 VDC, 56/111 mA Max. 110/220 VAC, 160/254 mA		
Connection	One removable 5-pin terminal block		
Overload Current Protection	Present		
Reverse Polarity Protection	Present		
Mechanical			
Casing	IP40 protection, metal case		
Dimensions	80 × 160 × 110 mm (W × H × D)		
Weight	1210 g		
Installation	DIN-Rail, Wall Mounting (optional kit)		

Environment	
Operating Temperature	-40 to 85°C (-40 to 185°F)
Storage Temperature	-40 to 85°C (-40 to 185°F)
Ambient Relative Humidity	5 to 95% (non-condensing)
Regulatory Approvals	
Safety	UL 508, CSA C22.2 No. 60950-1, EN 60950-1
Power Automaton	IEC 61850-3, IEEE 1613
EMI	FCC Part 15, CISPR (EN 55032) class A
WARRANTY	5 years